

# Basler aviator



## **USER'S MANUAL FOR GigE CAMERAS**

Document Number: AW000976

Version: 04 Language: 000 (English)

Release Date: 07 March 2018

### **For customers in the USA**

This equipment has been tested and found to comply with the limits for a Class A digital device, pursuant to Part 15 of the FCC Rules. These limits are designed to provide reasonable protection against harmful interference when the equipment is operated in a commercial environment. This equipment generates, uses, and can radiate radio frequency energy and, if not installed and used in accordance with the instruction manual, may cause harmful interference to radio communications. Operation of this equipment in a residential area is likely to cause harmful interference in which case the user will be required to correct the interference at his own expense.

You are cautioned that any changes or modifications not expressly approved in this manual could void your authority to operate this equipment.

The shielded interface cable recommended in this manual must be used with this equipment in order to comply with the limits for a computing device pursuant to Subpart B of Part 15 of FCC Rules.

### **For customers in Canada**

This apparatus complies with the Class A limits for radio noise emissions set out in Radio Interference Regulations.

### **Pour utilisateurs au Canada**

Cet appareil est conforme aux normes Classe A pour bruits radioélectriques, spécifiées dans le Règlement sur le brouillage radioélectrique.

### **Life Support Applications**

These products are not designed for use in life support appliances, devices, or systems where malfunction of these products can reasonably be expected to result in personal injury. Basler customers using or selling these products for use in such applications do so at their own risk and agree to fully indemnify Basler for any damages resulting from such improper use or sale.

**All material in this publication is subject to change without notice and is copyright Basler AG.**

## **Contacting Basler Support Worldwide**

### **Europe, Middle East, Africa**

Basler AG

An der Strusbek 60–62

22926 Ahrensburg

Germany

Tel. +49 4102 463 515

Fax +49 4102 463 599

[support.europe@baslerweb.com](mailto:support.europe@baslerweb.com)

### **The Americas**

Basler, Inc.

855 Springdale Drive, Suite 203

Exton, PA 19341

USA

Tel. +1 610 280 0171

Fax +1 610 280 7608

[support.usa@baslerweb.com](mailto:support.usa@baslerweb.com)

### **Asia-Pacific**

Basler Asia Pte. Ltd.

35 Marsiling Industrial Estate Road 3

#05–06

Singapore 739257

Tel. +65 6367 1355

Fax +65 6367 1255

[support.asia@baslerweb.com](mailto:support.asia@baslerweb.com)

**[www.baslerweb.com](http://www.baslerweb.com)**

## Table of Contents

<b>1</b>	<b>Specifications, Requirements, and Precautions</b>	<b>1</b>
1.1	Models	1
1.2	General Specifications	2
1.3	Accessories	5
1.4	Spectral Response	6
1.4.1	Monochrome Cameras	6
1.4.2	Color Cameras	7
1.5	Mechanical Specifications	8
1.5.1	Camera Dimensions and Mounting Points	8
1.5.2	Sensor Positioning Accuracy	10
1.5.3	Maximum Lens Thread Length on Color Cameras	11
1.5.4	Mechanical Stress Test Results	12
1.6	Software Licensing Information	13
1.6.1	LWIP TCP/IP Licensing	13
1.6.2	LZ4 Licensing	14
1.7	Avoiding EMI and ESD Problems	15
1.8	Environmental Requirements	16
1.8.1	Temperature and Humidity	16
1.8.2	Heat Dissipation	16
1.9	Precautions	17
<b>2</b>	<b>Installation</b>	<b>20</b>
<b>3</b>	<b>Camera Drivers and Tools for Changing Camera Parameters</b>	<b>21</b>
3.1	The Basler pylon Camera Software Suite	21
3.1.1	pylon Viewer	22
3.1.2	pylon IP Configurator	22
3.1.3	pylon SDKs	22
<b>4</b>	<b>Camera Functional Description</b>	<b>23</b>
4.1	Overview	23
4.1.1	Four Tap Sensor Digitization Mode	24
4.1.2	One Sensor Tap Digitization Mode	27
<b>5</b>	<b>Physical Interface</b>	<b>30</b>
5.1	General Description of the Camera Connections	30
5.2	Camera Connector Pin Assignments and Numbering	31
5.2.1	12-Pin Receptacle	31
5.2.2	8-Pin RJ-45 Jack	31
5.3	Camera Cabling Requirements	32
5.3.1	Ethernet Cables	32
5.3.2	Power-I/O Cable and Grounding	32
5.3.2.1	Grounding Recommendations	33

5.4	Camera Power	34
5.5	Ethernet GigE Device Information	34
5.6	Input Line Description	35
5.6.1	Voltage and Current Requirements	35
5.6.2	Circuit Diagram	36
5.6.3	Assigning an Input Line to Receive a Hardware Trigger Signal	37
5.7	Output Line Description	38
5.7.1	Voltage Requirements	38
5.7.2	Circuit Diagram	38
5.7.3	Response Times	40
5.7.4	Assigning a Camera Output Signal to an Output Line	40
<b>6</b>	<b>I/O Control</b>	<b>41</b>
6.1	Configuring the Input Lines	41
6.1.1	Assigning an Input Line to Receive a Hardware Trigger Signal	41
6.1.2	Input Line Debouncer	42
6.1.3	Using an Unassigned Input Line to Receive a User Input Signal	44
6.1.4	Setting an Input Line for Invert	44
6.2	Configuring Output Lines	45
6.2.1	Assigning a Camera Output Signal to an Output Line	45
6.2.2	Setting the State of a User Settable Output Line	47
6.2.3	Setting an Output Line for Invert	48
6.2.4	Working with the Timer Output Signals	49
6.2.4.1	Setting the Trigger Source for a Timer	49
6.2.4.2	Setting a Timer Delay Time	50
6.2.4.3	Setting the Timer Duration Time	52
6.3	Checking the State of the I/O Lines	54
6.3.1	Checking the State of a Single Line	54
6.3.2	Checking the State of All Lines	54
<b>7</b>	<b>Image Acquisition Control</b>	<b>55</b>
7.1	Overview	55
7.2	Acquisition Start and Stop Commands and the Acquisition Mode	60
7.3	The Acquisition Start Trigger	62
7.3.1	Acquisition Start Trigger Mode	62
7.3.1.1	Acquisition Start Trigger Mode = Off	62
7.3.1.2	Acquisition Start Trigger Mode = On	62
7.3.2	Acquisition Frame Count	64
7.3.3	Setting The Acquisition Start Trigger Mode and Related Parameters	65
7.3.4	Using a Software Acquisition Start Trigger Signal	66
7.3.4.1	Introduction	66
7.3.4.2	Setting the Parameters Related to Software Acquisition Start Triggering and Applying a Software Trigger Signal	66
7.3.5	Using a Hardware Acquisition Start Trigger Signal	68
7.3.5.1	Introduction	68
7.3.5.2	Acquisition Start Trigger Delay	69

7.3.5.3	Setting the Parameters Related to Hardware Acquisition Start Triggering and Applying a Hardware Trigger Signal . . . . .	69
7.4	The Frame Start Trigger . . . . .	71
7.4.1	Frame Start Trigger Mode . . . . .	72
7.4.1.1	Frame Start Trigger Mode = Off . . . . .	72
7.4.1.2	Frame Start Trigger Mode = On . . . . .	73
7.4.1.3	Setting The Frame Start Trigger Mode and Related Parameters . . . . .	74
7.4.2	Using a Software Frame Start Trigger Signal . . . . .	75
7.4.2.1	Introduction . . . . .	75
7.4.2.2	Setting the Parameters Related to Software Frame Start Triggering and Applying a Software Trigger Signal . . . . .	76
7.4.3	Using a Hardware Frame Start Trigger Signal . . . . .	77
7.4.3.1	Introduction . . . . .	77
7.4.3.2	Exposure Modes . . . . .	78
7.4.3.3	Frame Start Trigger Delay . . . . .	80
7.4.3.4	Setting the Parameters Related to Hardware Frame Start Triggering and Applying a Hardware Trigger Signal . . . . .	80
7.5	Setting the Exposure Time . . . . .	82
7.6	Overlapping Exposure with Sensor Readout . . . . .	83
7.7	Acquisition Monitoring Tools . . . . .	85
7.7.1	The Exposure Active Signal . . . . .	85
7.7.2	Acquisition Status Indicator . . . . .	86
7.7.3	Trigger Wait Signals . . . . .	87
7.7.3.1	Acquisition Trigger Wait Signal . . . . .	87
7.7.3.2	Frame Trigger Wait Signal . . . . .	89
7.8	Acquisition Timing Chart . . . . .	91
7.9	Maximum Allowed Frame Rate . . . . .	93
7.9.1	Using Basler pylon to Check the Maximum Allowed Frame Rate . . . . .	94
7.9.2	Increasing the Maximum Allowed Frame Rate . . . . .	94
7.10	Use Case Descriptions and Diagrams . . . . .	96
<b>8</b>	<b>Color Creation and Enhancement . . . . .</b>	<b>104</b>
8.1	Color Creation . . . . .	104
8.1.1	Bayer Color Filter Alignment . . . . .	105
8.1.2	Pixel Formats Available on Cameras with a Bayer Filter . . . . .	105
8.2	Integrated IR Cut Filter (on Color Models) . . . . .	107
8.3	Color Enhancement Features . . . . .	108
8.3.1	White Balance . . . . .	108
8.3.2	Gamma Correction . . . . .	110
8.3.3	Matrix Color Transformation on Color Models . . . . .	112
8.3.3.1	The Custom Light Source Setting . . . . .	114
8.3.4	Color Adjustment . . . . .	116
8.3.5	A Procedure for Setting the Color Enhancements . . . . .	121
8.3.6	The "Color" Factory Setup . . . . .	122

<b>9</b>	<b>Pixel Formats</b>	<b>123</b>
9.1	Setting the Pixel Format	123
9.2	Pixel Formats for Mono Cameras	125
9.2.1	Mono 8 Format	125
9.2.2	Mono 12 Format	126
9.2.3	Mono 12 Packed Format	128
9.2.4	YUV 4:2:2 Packed Format	130
9.2.5	YUV 4:2:2 (YUYV) Packed Format	130
9.3	Pixel Data Output Formats for Color Cameras	131
9.3.1	Bayer GB 8 Format	131
9.3.2	Bayer GB 12 Format	133
9.3.3	Bayer GB 12 Packed Format	135
9.3.4	YUV 4:2:2 Packed Format	137
9.3.5	YUV 4:2:2 (YUYV) Packed Format	139
9.3.6	Mono 8 Format	141
9.4	Pixel Transmission Sequence	143
<b>10</b>	<b>Standard Features</b>	<b>144</b>
10.1	Sensor Digitization Taps	144
10.2	Gain	145
10.2.1	Gain with Four Tap Sensor Digitization	146
10.2.2	Gain with One Tap Sensor Digitization	148
10.3	Black Level	149
10.3.1	Black Level with Four Tap Sensor Digitization	149
10.3.2	Black Level with One Tap Sensor Digitization	151
10.4	Remove Parameter Limits	152
10.5	Digital Shift	153
10.5.1	Digital Shift with 12 Bit Pixel Formats	153
10.5.2	Digital Shift with 8 Bit Pixel Formats	155
10.5.3	Precautions When Using Digital Shift	157
10.5.4	Enabling and Setting Digital Shift	158
10.6	Image Area of Interest (AOI)	159
10.6.1	Setting the Image AOI	160
10.6.2	Prelines	162
10.7	Auto Functions	164
10.7.1	Common Characteristics	164
10.7.2	Auto Function Operating Modes	166
10.7.3	Auto Function AOIs	167
10.7.3.1	Assignment of an Auto Function to an Auto Function AOI	168
10.7.3.2	Positioning of an Auto Function AOI Relative to the Image AOI	169
10.7.3.3	Setting an Auto Function AOI	171
10.7.4	Using an Auto Function	172
10.7.5	Gain Auto	173
10.7.6	Exposure Auto	175
10.7.7	Gray Value Adjustment Damping	177

10.7.8	Auto Function Profile .....	178
10.7.9	Balance White Auto .....	179
10.8	Minimum Output Pulse Width .....	181
10.9	Error Codes .....	183
10.10	Sequencer .....	185
10.10.1	Auto Sequence Advance Mode .....	191
10.10.1.1	Operation .....	191
10.10.1.2	Configuration .....	194
10.10.2	Controlled Sequence Advance Mode .....	197
10.10.2.1	Operation with the "Always Active" Sequence Control Source .....	197
10.10.2.2	Operation with an Input Line as Sequence Control Source .....	202
10.10.2.3	Operation with the "Disabled" Sequence Control Source .....	208
10.10.2.4	Configuration .....	212
10.10.3	Free Selection Sequence Advance Mode .....	216
10.10.3.1	Operation .....	216
10.10.3.2	Configuration .....	220
10.11	Binning .....	223
10.11.1	Considerations When Using Binning .....	225
10.12	Mirror Imaging .....	227
10.12.1	Reverse X .....	227
10.12.2	Reverse Y .....	229
10.12.3	Enabling Reverse X and Reverse Y .....	231
10.13	Luminance Lookup Table .....	232
10.14	Event Reporting .....	235
10.15	User Defined Values .....	238
10.16	Test Images .....	239
10.16.1	Test Image Descriptions .....	240
10.17	Device Information Parameters .....	243
10.18	Imaging Sensor Temperature Monitoring and Over Temperature Detection .....	245
10.18.1	Imaging Sensor Temperature .....	245
10.18.2	Imaging Sensor Temperature Conditions .....	246
10.19	Configuration Sets .....	247
10.19.1	Selecting a Factory Setup as the Default Set .....	249
10.19.2	Saving User Sets .....	250
10.19.3	Loading a Saved User Set or the Default Set into the Active Set .....	251
10.19.4	Selecting a "Startup" Set .....	252
10.20	Camera Feature Set .....	253
<b>11</b>	<b>Chunk Features .....</b>	<b>255</b>
11.1	What are Chunk Features? .....	255
11.2	Making the "Chunk Mode" Active and Enabling the Extended Data Stamp .....	256
11.3	Frame Counter .....	258
11.4	Time Stamp .....	261
11.5	Trigger Input Counter .....	262



11.6	Line Status All	265
11.7	CRC Checksum	267
11.8	Sequence Set Index	269
<b>12</b>	<b>Technical Support</b>	<b>270</b>
12.1	Technical Support Resources	270
12.2	Obtaining an RMA Number	270
12.3	Before Contacting Basler Technical Support	270
A.1	The Basler Filter Driver	275
A.2	The Basler Performance Driver	276
A.2.1	General Parameters	277
A.2.2	Threshold Resend Mechanism Parameters	277
A.2.3	Timeout Resend Mechanism Parameters	279
A.2.4	Threshold and Timeout Resend Mechanisms Combined	281
A.2.5	Adapter Properties	283
A.2.6	Transport Layer Parameters	284
B.1	Network Related Parameters in the Camera	285
B.2	Managing Bandwidth When Multiple Cameras Share a Single Network Path	292
B.3	A Procedure for Managing Bandwidth	294
	<b>Revision History</b>	<b>299</b>
	<b>Index</b>	<b>302</b>

# 1 Specifications, Requirements, and Precautions

This chapter lists the camera models covered by the manual. It provides the general specifications for those models and the basic requirements for using them.

This chapter also includes specific precautions that you should keep in mind when using the cameras. We strongly recommend that you read and follow the precautions.

## 1.1 Models

The current Basler aviator GigE camera models are listed in the top row of the specification table on the next pages of this manual. The camera models are differentiated by their resolution and by whether the camera's sensor is mono or color.

Unless otherwise noted, the material in this manual applies to all of the camera models listed in the specification table. Material that only applies to a particular camera model or to a subset of models, such as to color cameras only, is so designated.

## 1.2 General Specifications

Specification	avA1000-100gm	avA1000-100gc	avA1600-50gm	avA1600-50gc
Sensor Resolution (H x V pixels) nominal: maximum:	1024 x 1024 pixels 1040 x 1040 pixels	1024 x 1024 pixels 1036 x 1036 pixels	1600 x 1200 pixels 1640 x 1240 pixels	1600 x 1200 pixels 1636 x 1236 pixels
Sensor Type	ON Semiconductor® KAI-01050 Progressive scan CCD		ON Semiconductor® KAI-02050 Progressive scan CCD	
Optical Size	1/2"		2/3"	
Effective Sensor Diagonal	5.5 mm	5.5 mm	5.5 mm	5.5 mm
Pixel Size	5.5 µm x 5.5 µm			
Max Frame Rate (at nominal resolution)	101 fps		55 fps	
Mono/Color	Mono	Color	Mono	Color
Data Output Type	Fast Ethernet (100 Mbit/s) or Gigabit Ethernet (1000 Mbit/s)			
Sensor Taps	1 tap or 4 taps			
ADC Bit Depth	12 bit			
Pixel Format	Mono Models: Mono 8 Mono 12 Mono 12 Packed YUV 4:2:2 Packed YUV 4:2:2 (YUYV) Packed		Color Models: Mono 8 Bayer GB 8 Bayer GB 12 Bayer GB 12 Packed YUV 4:2:2 Packed YUV 4:2:2 (YUYV) Packed	
Synchronization	Via hardware trigger, via software trigger, or free run			
Exposure Time Control	Via hardware trigger or programmable via the camera API			
Camera Power Requirements	+12 VDC (± 10%), < 1% ripple			
Power Consumption	5.6 W @ 12 VDC		5.8 W @ 12 VDC	
I/O Lines	2 opto-isolated input lines and 4 opto-isolated output lines			
Lens Adapter	C-mount			
Size (L x W x H)	40.7 mm x 62.0 mm x 62.0 mm (without lens adapter or connectors) 56.3 mm x 62.0 mm x 62.0 mm (with lens adapter and connectors)			
Weight	≈ 300 g (typical)			

Table 1: General Specifications

---

Specification	avA1000-100 gm	avA1000-100gc	avA1600-50gm	avA1600-50gc
Conformity	CE (includes RoHS), FCC, IP30, GenICam, GigE Vision, REACH The EU Declaration of Conformity is available on the Basler website: <a href="http://www.baslerweb.com">www.baslerweb.com</a>			
Software	Basler pylon Camera Software Suite (version 4.0 or higher) Available for Windows, Linux x86, Linux ARM, and OS X			

Table 1: General Specifications

Specification	avA1900-50gm	avA1900-50gc	avA2300-25gm	avA2300-25gc
Sensor Resolution (H x V pixels) nominal: maximum:	1920 x 1080 pixels 1960 x 1120 pixels	1920 x 1080 pixels 1956 x 1116 pixels	2330 x 1750 pixels 2360 x 1776 pixels	2332 x 1752 pixels 2356 x 1772 pixels
Sensor Type	ON Semiconductor® KAI-02150 Progressive scan CCD		ON Semiconductor® KAI-04050 Progressive scan CCD	
Optical Size	2/3"		1"	
Effective Sensor Diagonal	5.5 mm	5.5 mm	5.5 mm	5.5 mm
Pixel Size	5.5 µm x 5.5 µm			
Max Frame Rate (at nominal resolution)	51 fps		26 fps	
Mono/Color	Mono	Color	Mono	Color
Data Output Type	Fast Ethernet (100 Mbit/s) or Gigabit Ethernet (1000 Mbit/s)			
Sensor Taps	1 tap or 4 taps			
ADC Bit Depth	12 bit			
Pixel Format	Mono Models: Mono 8 Mono 12 Mono 12 Packed YUV 4:2:2 Packed YUV 4:2:2 (YUYV) Packed		Color Models: Mono 8 Bayer GB 8 Bayer GB 12 Bayer GB 12 Packed YUV 4:2:2 Packed YUV 4:2:2 (YUYV) Packed	
Synchronization	Via hardware trigger, via software trigger, or free run			
Exposure Time Control	Via hardware trigger or programmable via the camera API			
Camera Power Requirements	+12 VDC (± 10%), < 1% ripple			
Power Consumption	5.8 W @ 12 VDC		6.3 W @ 12 VDC	
I/O Lines	2 opto-isolated input lines and 4 opto-isolated output lines			
Lens Adapter	C-mount			
Size (L x W x H)	40.7 mm x 62.0 mm x 62.0 mm (without lens adapter or connectors) 56.3 mm x 62.0 mm x 62.0 mm (with lens adapter and connectors)			
Weight	≈ 300 g (typical)			
Conformity	CE (includes RoHS), FCC, IP30, GenICam, GigE Vision, REACH			

Table 2: General Specifications

Specification	avA1900-50gm	avA1900-50gc	avA2300-25gm	avA2300-25gc
Software	Basler pylon Camera Software Suite (version 4.0 or higher) Available for Windows, Linux x86, Linux ARM, and OS X			

Table 2: General Specifications

## 1.3 Accessories



Fig. 1: Basler Accessories

Basler's cooperation with carefully selected suppliers means you get accessories you can trust which makes building a high-performance image processing system hassle-free.

### Key Reasons for Choosing Lenses, Cables, and Other Accessories from Basler

- Perfect match for Basler cameras
- One-stop-shopping for your image processing system
- Stable performance through highest quality standards
- Easy integration into existing systems
- Expert advice during selection process

See the Basler website for information about Basler's extensive accessories portfolio (e.g. cables, lenses, host adapter cards, switches): [www.baslerweb.com](http://www.baslerweb.com)

## 1.4 Spectral Response

### 1.4.1 Monochrome Cameras

The following graph shows the spectral response for all monochrome cameras.

	The spectral response curve excludes lens characteristics and light source characteristics.
---	---

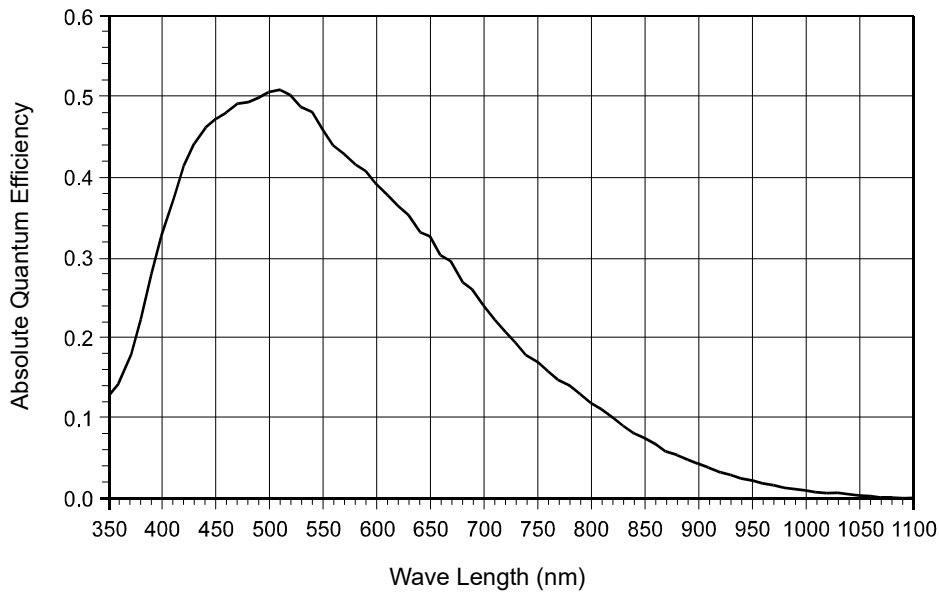



Fig. 2: Mono Camera Spectral Response

## 1.4.2 Color Cameras

The following graph shows the spectral response for all color cameras.

	<p>The spectral response curves excludes lens characteristics, light source characteristics, and IR cut filter characteristics. To obtain best performance from color models of the camera, use of a dielectric IR cut filter is recommended.</p> <p>The filter should transmit in a range from 400 nm to 640 ... 660 nm, and it should cut off from 640 ... 660 nm to 1100 nm.</p> <p>A suitable IR cut filter is included in the standard C-mount lens adapter on color models of the camera.</p>
---	---

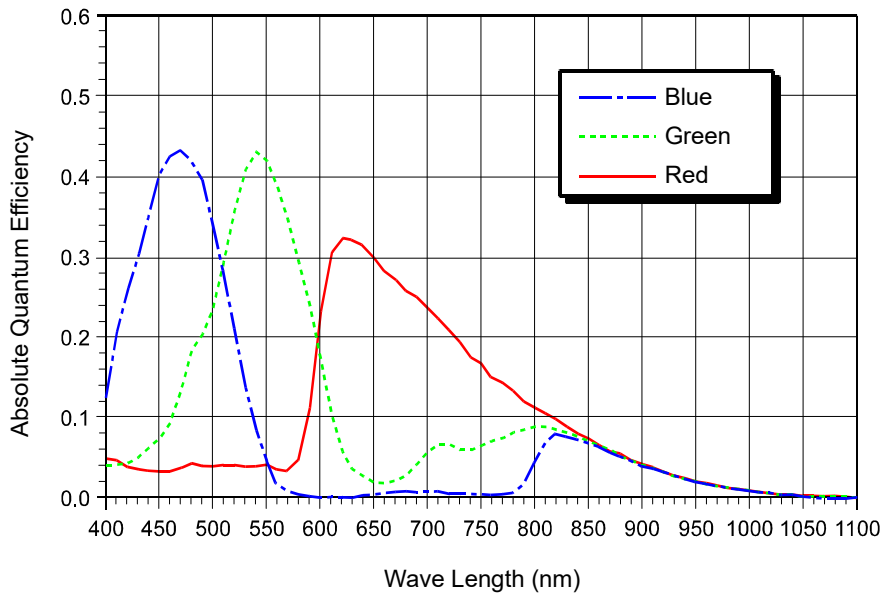

Fig. 3: Color Camera Spectral Response



## 1.5 Mechanical Specifications

The camera housing conforms to protection class IP30 assuming that the lens mount is covered by a lens or by the cap that is shipped with the camera.

### 1.5.1 Camera Dimensions and Mounting Points

The cameras are manufactured with high precision. Planar, parallel, and angular sides ensure precise mounting with high repeatability.

Camera housings are equipped with four mounting holes on the front and two mounting holes on each side as shown in Figure 4 on [page 9](#).

For mounting on a tripod, a suitable tripod adapter is available from Basler.

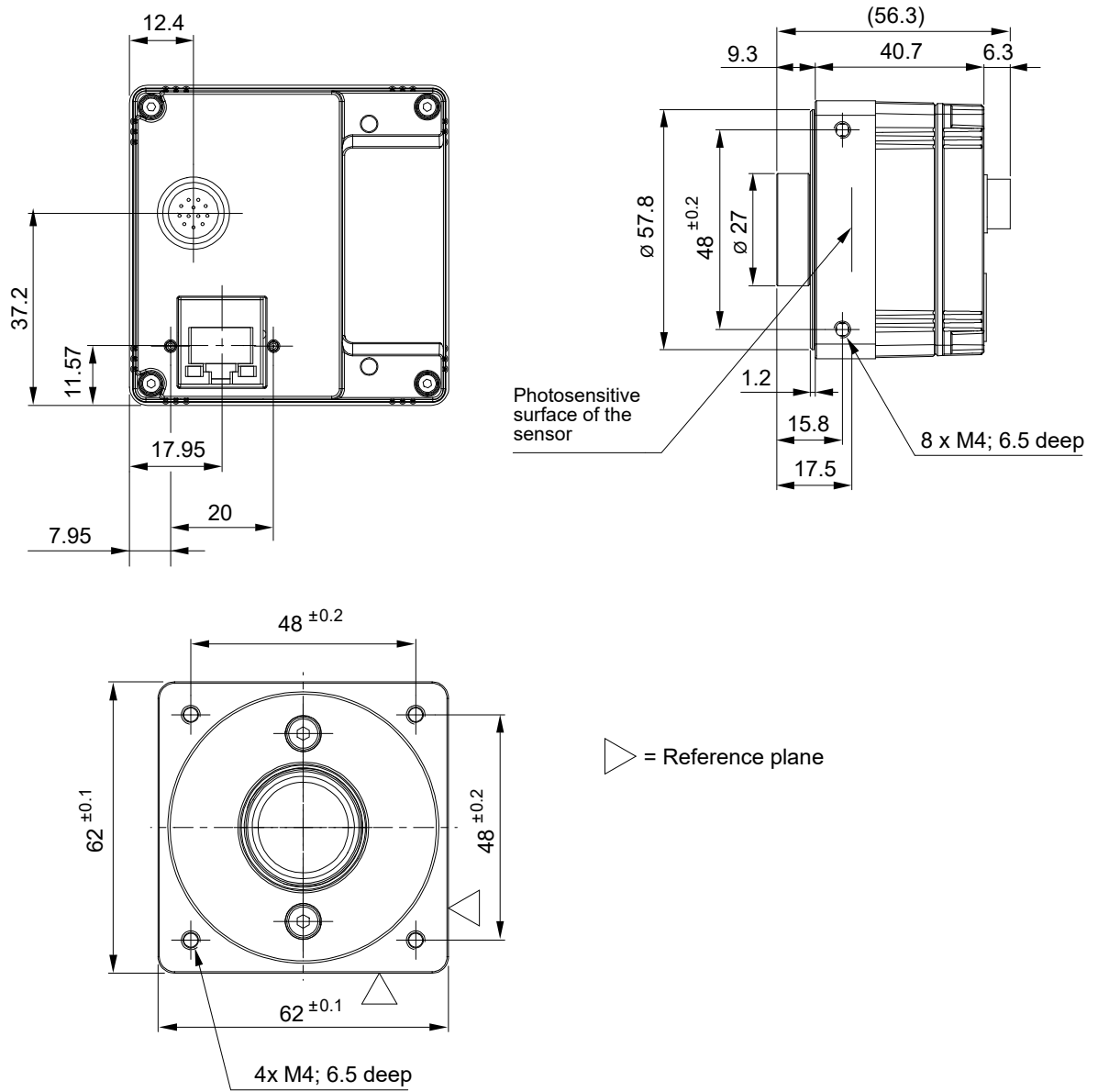

Fig. 4: Mechanical Dimensions (in mm)

## 1.5.2 Sensor Positioning Accuracy

The sensor positioning accuracy is as shown Figure 5.

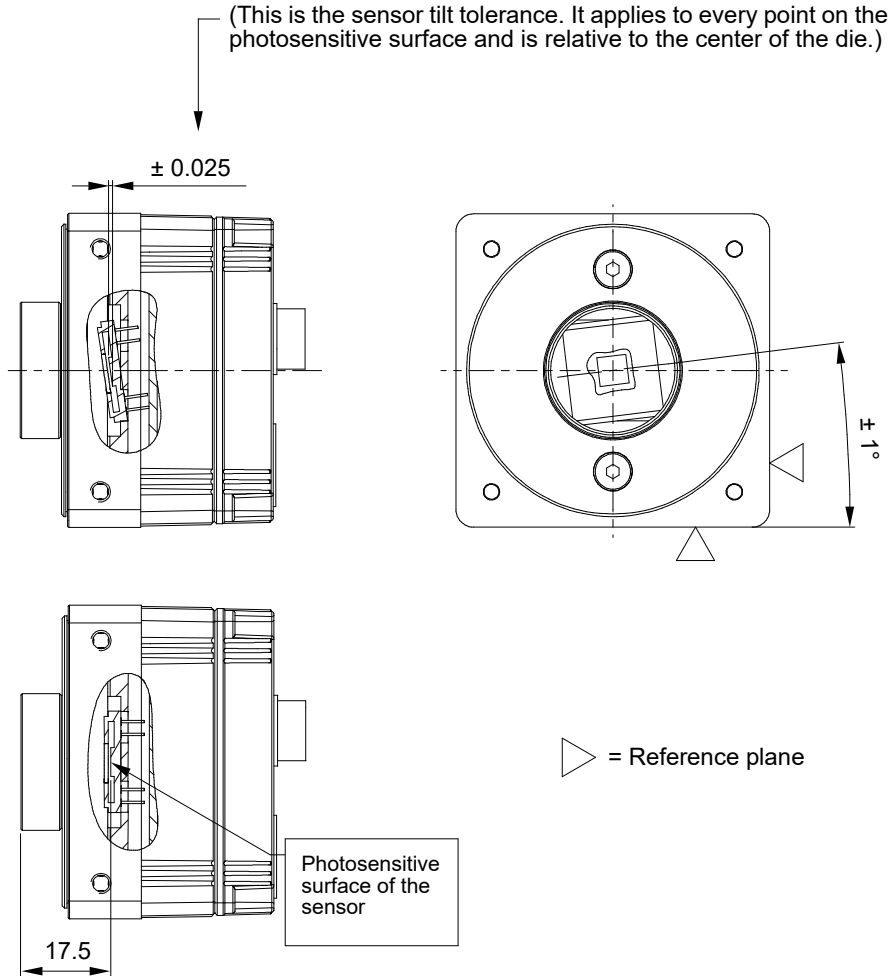

Fig. 5: Sensor Positioning Accuracy (in mm unless otherwise noted)

### 1.5.3 Maximum Lens Thread Length on Color Cameras

The C-mount lens adapter on color models of the camera is normally equipped with an internal IR cut filter. As shown in Figure 6, the length of the threads on any lens you use with a color camera must be less than 7.5 mm. If a lens with a longer thread length is used, the IR cut filter will be damaged or destroyed and the camera will no longer operate.

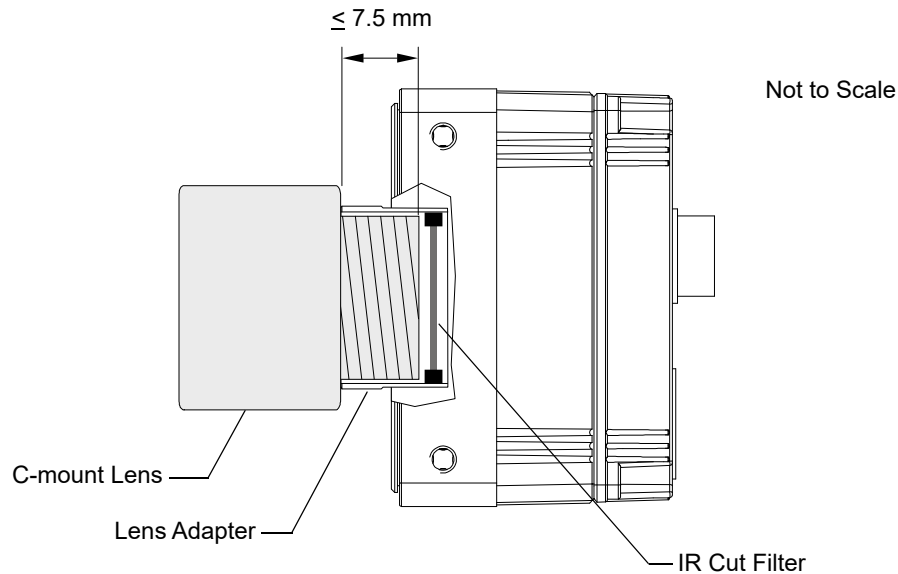

Fig. 6: Maximum Lens Thread Length on Color Cameras



C-mount color cameras that do not include an internal IR cut filter are available on request.

Monochrome cameras are not normally equipped with an internal IR cut filter, however, they can be equipped with an internal filter on request.

## 1.5.4 Mechanical Stress Test Results

Aviator cameras were submitted to an independent mechanical testing laboratory and subjected to the stress tests listed below. The mechanical stress tests were performed on selected camera models. After mechanical testing, the cameras exhibited no detectable physical damage and produced normal images during standard operational testing.

Test	Standard	Conditions
Vibration (sinusoidal, each axis)	DIN EN 60068-2-6	10-58 Hz / 1.5 mm_58-500 Hz / 20 g_1 Octave/Minute 10 repetitions
Shock (each axis)	DIN EN 60068-2-27	20 g / 11 ms / 10 shocks positive 20 g / 11 ms / 10 shocks negative
Bump (each axis)	DIN EN 60068-2-29	20 g / 11 ms / 100 shocks positive 20 g / 11 ms / 100 shocks negative
Vibration (broad-band random, digital control, each axis)	DIN EN 60068-2-64	15-500 Hz / 0.05 PSD (ESS standard profile) / 00:30 h

Table 1: Mechanical Stress Tests

The mechanical stress tests were performed with a dummy lens connected to a C-mount. The dummy lens was 35 mm long and had a mass of 66 g. Using a heavier or longer lens requires an additional support for the lens.

## 1.6 Software Licensing Information

### 1.6.1 LWIP TCP/IP Licensing

The software in the camera includes the LWIP TCP/IP implementation. The copyright information for this implementation is as follows:

Copyright (c) 2001, 2002 Swedish Institute of Computer Science. All rights reserved.

Redistribution and use in source and binary forms, with or without modification, are permitted provided that the following conditions are met:

1. Redistributions of source code must retain the above copyright notice, this list of conditions and the following disclaimer.
2. Redistributions in binary form must reproduce the above copyright notice, this list of conditions and the following disclaimer in the documentation and/or other materials provided with the distribution.
3. The name of the author may not be used to endorse or promote products derived from this software without specific prior written permission.

THIS SOFTWARE IS PROVIDED BY THE AUTHOR "AS IS" AND ANY EXPRESS OR IMPLIED WARRANTIES, INCLUDING, BUT NOT LIMITED TO, THE IMPLIED WARRANTIES OF MERCHANTABILITY AND FITNESS FOR A PARTICULAR PURPOSE ARE DISCLAIMED.

IN NO EVENT SHALL THE AUTHOR BE LIABLE FOR ANY DIRECT, INDIRECT, INCIDENTAL, SPECIAL, EXEMPLARY, OR CONSEQUENTIAL DAMAGES (INCLUDING, BUT NOT LIMITED TO, PROCUREMENT OF SUBSTITUTE GOODS OR SERVICES; LOSS OF USE, DATA, OR PROFITS; OR BUSINESS INTERRUPTION) HOWEVER CAUSED AND ON ANY THEORY OF LIABILITY, WHETHER IN CONTRACT, STRICT LIABILITY, OR TORT (INCLUDING NEGLIGENCE OR OTHERWISE) ARISING IN ANY WAY OUT OF THE USE OF THIS SOFTWARE, EVEN IF ADVISED OF THE POSSIBILITY OF SUCH DAMAGE.

## 1.6.2 LZ4 Licensing

The software in the camera includes the LZ4 implementation. The copyright information for this implementation is as follows:

LZ4 - Fast LZ compression algorithm

Copyright (C) 2011-2013, Yann Collet.

BSD 2-Clause License (<http://www.opensource.org/licenses/bsd-license.php>)

Redistribution and use in source and binary forms, with or without modification, are permitted provided that the following conditions are met:

1. Redistributions of source code must retain the above copyright notice, this list of conditions and the following disclaimer.
2. Redistributions in binary form must reproduce the above copyright notice, this list of conditions and the following disclaimer in the documentation and/or other materials provided with the distribution.

THIS SOFTWARE IS PROVIDED BY THE COPYRIGHT HOLDERS AND CONTRIBUTORS "AS IS" AND ANY EXPRESS OR IMPLIED WARRANTIES, INCLUDING, BUT NOT LIMITED TO, THE IMPLIED WARRANTIES OF MERCHANTABILITY AND FITNESS FOR A PARTICULAR PURPOSE ARE DISCLAIMED. IN NO EVENT SHALL THE COPYRIGHT OWNER OR CONTRIBUTORS BE LIABLE FOR ANY DIRECT, INDIRECT, INCIDENTAL, SPECIAL, EXEMPLARY, OR CONSEQUENTIAL DAMAGES (INCLUDING, BUT NOT LIMITED TO, PROCUREMENT OF SUBSTITUTE GOODS OR SERVICES; LOSS OF USE, DATA, OR PROFITS; OR BUSINESS INTERRUPTION) HOWEVER CAUSED AND ON ANY THEORY OF LIABILITY, WHETHER IN CONTRACT, STRICT LIABILITY, OR TORT (INCLUDING NEGLIGENCE OR OTHERWISE) ARISING IN ANY WAY OUT OF THE USE OF THIS SOFTWARE, EVEN IF ADVISED OF THE POSSIBILITY OF SUCH DAMAGE.

I

## 1.7 Avoiding EMI and ESD Problems

The cameras are frequently installed in industrial environments. These environments often include devices that generate electromagnetic interference (EMI) and they are prone to electrostatic discharge (ESD). Excessive EMI and ESD can cause problems with your camera such as false triggering or can cause the camera to suddenly stop capturing images. EMI and ESD can also have a negative impact on the quality of the image data transmitted by the camera.

To avoid problems with EMI and ESD, you should follow these general guidelines:

- Always use high quality shielded cables. The use of high quality cables is one of the best defenses against EMI and ESD.
- Avoid to coil camera cables. If the cables are too long, use a meandering path.
- Avoid placing camera cables parallel to wires carrying high-current, switching voltages such as wires supplying stepper motors or electrical devices that employ switching technology. **Placing camera cables near to these types of devices may cause problems with the camera.**
- Attempt to connect all grounds to a single point, e.g., use a single power outlet for the entire system and connect all grounds to the single outlet. This will help to avoid large ground loops. (Large ground loops can be a primary cause of EMI problems.)
- Use a line filter on the main power supply.
- Install the camera and camera cables as far as possible from devices generating sparks. If necessary, use additional shielding.
- Decrease the risk of electrostatic discharge by taking the following measures:
  - Use conductive materials at the point of installation (e.g., floor, workplace).
  - Use suitable clothing (cotton) and shoes.
  - Control the humidity in your environment. Low humidity can cause ESD problems.



The Basler application note called *Avoiding EMI and ESD in Basler Camera Installations* provides much more detail about avoiding EMI and ESD. This application note can be obtained from the Basler website: [www.baslerweb.com](http://www.baslerweb.com)



## 1.8 Environmental Requirements

### 1.8.1 Temperature and Humidity



Housing temperature during operation:	0 °C ... +50 °C (+32 °F ... +122 °F)
Humidity during operation:	20 % ... 80 %, relative, non-condensing
Storage temperature:	-20 °C ... +80 °C (-4 °F ... +176 °F)
Storage humidity:	20 % ... 80 %, relative, non-condensing



### 1.8.2 Heat Dissipation

You must provide sufficient heat dissipation to maintain the temperature of the camera housing at 50 °C or less. Since each installation is unique, Basler does not supply a strictly required technique for proper heat dissipation. Instead, we provide the following general guidelines:

- In all cases, you should monitor the temperature of the camera housing and make sure that the temperature does not exceed 50 °C. Keep in mind that the camera will gradually become warmer during the first 1.5 hours of operation. After 1.5 hours, the housing temperature should stabilize and no longer increase.
- If your camera is mounted on a substantial metal component in your system, this may provide sufficient heat dissipation.
- The use of a fan to provide air flow over the camera is an extremely efficient method of heat dissipation. The use of a fan provides the best heat dissipation.

## 1.9 Precautions

	 <b>DANGER</b>
	<p><b>Electric Shock Hazard</b></p> <p>Risk of Burn or Death.</p> <p>The power supplies used for supplying</p> <ul style="list-style-type: none"> <li>■ power to the I/O lines and</li> <li>■ camera power</li> </ul> <p>must meet the Safety Extra Low Voltage (SELV) and Limited Power Source (LPS) requirements.</p>

	 <b>WARNING</b>
	<p><b>Fire Hazard</b></p> <p>Risk of Burn</p> <p>The power supplies used for supplying</p> <ul style="list-style-type: none"> <li>■ power to the I/O lines and</li> <li>■ camera power</li> </ul> <p>must meet the Limited Power Source (LPS) requirements.</p>

<b>NOTICE</b>
<p>Avoid dust on the sensor.</p> <p>The camera is shipped with a cap on the lens mount. To avoid collecting dust on the camera's IR cut filter (color cameras) or sensor (mono cameras), make sure that you always put the cap in place when there is no lens mounted on the camera.</p> <p>To avoid collecting dust on the camera's IR cut filter (color cameras) or sensor (mono cameras), make sure to observe the following:</p> <ul style="list-style-type: none"> <li>■ Always put the plastic cap in place when there is no lens mounted on the camera.</li> <li>■ Make sure that the camera is pointing down every time you remove or replace the plastic cap or a lens.</li> </ul> <p>Never apply compressed air to the camera. This can easily contaminate optical components, particularly the sensor.</p>

**NOTICE**

On color cameras, the lens thread length is limited.

Color models of the camera with a C-mount lens adapter are equipped with an IR cut filter mounted inside of the adapter. The location of this filter limits the length of the threads on any lens you use with the camera. If a lens with a very long thread length is used, the IR cut filter will be damaged or destroyed and the camera will no longer operate. Do not use a lens with a thread length greater than 7.5 mm.

For more specific information about the lens thread length, see Section 1.5.3 on [page 11](#).

**NOTICE**

Applying incorrect power can damage the camera.

1. The camera's nominal operating voltage is +12 VDC ( $\pm 10\%$ ). If the voltage applied to the camera is greater than +13.2 VDC, severe damage to the camera can result. If the voltage is less than +10.8 VDC, the camera may operate erratically.
2. Make sure that the polarity of the power applied to the camera is correct. Applying power with the wrong polarity can result in severe damage to the camera.

**NOTICE**

An incorrect plug can damage the camera's 12-pin connector.

The plug on the cable that you attach to the camera's 12-pin connector must have 12 female pins. Using a plug designed for a smaller or a larger number of pins can damage the connector.

**NOTICE**

Inappropriate code may cause unexpected camera behavior.

1. The code snippets provided in this manual are included as sample code only. Inappropriate code may cause your camera to function differently than expected and may compromise your application.
2. To ensure that the snippets will work properly in your application, you must adjust them to meet your specific needs and must test them thoroughly prior to use.
3. The code snippets in this manual are written in C++. Other programming languages can also be used to write code for use with Basler pylon. When writing code, you should use a programming language that is both compatible with pylon and appropriate for your application. For more information about the programming languages that can be used with Basler pylon, see the documentation included with the pylon package.

**NOTICE**

Cleaning of the sensor.

Avoid cleaning the surface of the camera's sensor if possible. If you must clean it:

- Before starting, disconnect the camera from camera power and I/O power.
- Use a soft, lint-free cloth dampened with a small amount of window cleaner.
- Because electrostatic discharge can damage the sensor, you must use a cloth that won't generate static during cleaning (cotton is a good choice).
- Make sure the window cleaner has evaporated after cleaning, before reconnecting the camera to power.

Cleaning of the housing:

- Before starting, disconnect the camera from camera power and I/O power.
- Use a soft dry cloth. To remove severe stains, use a soft cloth dampened with a small quantity of detergent, then wipe dry.
- Because electrostatic discharge can damage the camera, you must use a cloth that won't generate static during cleaning (cotton is a good choice).

Do not use solvents or thinners. They can damage the surface finish.

**Observe the Following Items:**

- Do not remove the camera's product label that contains the serial number.
- Do not open the housing and do not touch the internal components, you may damage them.
- Prevent ingress or insertion of foreign substances into the camera housing. If operated with any foreign substances inside, the camera may fail or cause a fire.
- Do not operate the camera in the vicinity of strong electromagnetic fields. Avoid electrostatic charging.
- Transport the camera in its original packaging only. Do not discard the packaging.

## 2 Installation

The information you will need to do an installation of the camera is included in the *Installation and Setup Guide for Cameras Used with Basler's pylon API* (AW000611).

You can download the document from the Basler website: [www.baslerweb.com](http://www.baslerweb.com)

The install and setup guide includes extensive information about how to install both hardware and software and how to begin capturing images. It also describes the recommended network adapters, describes the recommended architecture for the network to which your camera is attached, and deals with the IP configuration of your camera and network adapter.

After completing your camera installation, refer to the "Basler Network Drivers and Parameters" and "Network Related Camera Parameters and Managing Bandwidth" sections of this camera User's Manual for information about improving your camera's performance in a network and about using multiple cameras.



After the camera is powered on, pylon software processes a camera description file included in the camera to make the camera features available for use.

The following camera description files are available and are used alternatively:

- The "Full" camera description file providing all features.
- The "Basic" camera description file providing most features.

Processing the "Full" camera description file takes more time than processing the "Basic" camera description file. Accordingly, processing the "Basic" camera description file requires a shorter period to elapse until the camera features are available for use.

After the initial start of the camera, the Basler aviator GigE camera is configured by the factory to process the "Full" camera description file.

If you do not require all features, and if you want to make the camera features sooner available, you must activate the "Basic" camera description file.

For more information, particularly about activating a camera description file and about the features not provided by the smaller camera description file, see Section 10.20 on [page 253](#).

# 3 Camera Drivers and Tools for Changing Camera Parameters

This chapter provides an overview of the camera drivers and the options available for changing the camera's parameters.

The options available with the Basler pylon Camera Software Suite let you change parameters and control the camera by using a stand-alone GUI (known as the pylon Viewer) or by accessing the camera from within your software application using the [driver API](#).

## 3.1 The Basler pylon Camera Software Suite

The Basler pylon Camera Software Suite is designed to operate all Basler cameras that have an IEEE 1394a/b interface, a GigE interface, or a USB 3 interface. It also operates some newer Basler camera models with a Camera Link interface. The pylon drivers offer reliable, real-time image data transport into the memory of your computer at a very low CPU load.

The options available with the Basler pylon Camera Software Suite let you

- change parameters and control the camera by using a standalone GUI known as the Basler pylon Viewer.
- change parameters and control the camera from within your software application using the Basler pylon SDKs.
- obtain information about the USB camera device and other USB devices connected to your host computer by using the Basler pylon USB Configurator.

You can obtain the Basler pylon Camera Software Suite from the Basler website:

[www.baslerweb.com](http://www.baslerweb.com)

To help you install the drivers, you can also download the *Installation and Setup Guide for Cameras Used with Basler's pylon API* (AW000611) from the website.

The pylon software includes several tools that you can use to change the parameters on your camera including the pylon Viewer, the pylon IP Configurator, and the pylon SDK. The remaining sections in this chapter provide an introduction to the tools.

### 3.1.1 pylon Viewer

The pylon Viewer is included in the Basler pylon Camera Software Suite. The pylon Viewer is a standalone application that lets you view and change most of the camera's parameter settings via a GUI. The viewer also lets you acquire images, display them, and save them. Using the pylon Viewer software is a very convenient way to get your camera up and running quickly when you are doing your initial camera evaluation or doing a camera design-in for a new project.

For more information about using the viewer, see the *Installation and Setup Guide for Cameras Used with Basler's pylon API* (AW000611).

### 3.1.2 pylon IP Configurator

The pylon IP Configurator is included in the Basler pylon Camera Software Suite. The pylon IP Configurator is a standalone application that lets you change the IP configuration of the camera via a GUI. The tool detects all Basler GigE cameras attached to your network and lets you make changes to a selected camera.

For more information about using the IP Configurator, see the *Installation and Setup Guide for Cameras Used with Basler's pylon API* (AW000611).

### 3.1.3 pylon SDKs

Three pylon SDKs are part of the Basler pylon Camera Software Suite:

- pylon SDK for C++ (Windows and Linux)
- pylon SDK for C (Windows and Linux)
- pylon SDK for .NET / C# (Windows)

Each SDK includes an application programming interface (API), a set of sample programs, and documentation:

- You can access all of the camera's parameters and control the camera's full functionality from within your application software by using the matching pylon API (C++, C, or .NET).
- The sample programs illustrate how to use the pylon API to parameterize and operate the camera.
- For each environment (C++, C, and .NET), a *Programmer's Guide and Reference Documentation* is available. The documentation gives an introduction to the pylon API and provides information about all methods and objects of the API..

The pylon SDK is available from the Basler website: [www.baslerweb.com](http://www.baslerweb.com)

For more information about installing pylon software, see the *installation and Setup Guide for Cameras Used with Basler's pylon API* (AW000611). You can download the guide from the Basler website: [www.baslerweb.com](http://www.baslerweb.com)

# 4 Camera Functional Description

This chapter provides an overview of the camera's functionality from a system perspective. The overview will aid your understanding when you read the more detailed information included in the later chapters of the user's manual.

## 4.1 Overview

Each camera provides features such as a full frame shutter and electronic exposure time control.

Exposure start and exposure time can be controlled by parameters transmitted to the camera via the Basler pylon API and the GigE interface. There are also parameters available to set the camera for single frame acquisition or continuous frame acquisition.

Exposure start can also be controlled via an externally generated hardware "frame start trigger" (ExFSTrig) signal applied to one of the camera's input lines. The ExFSTrig signal facilitates periodic or non-periodic acquisition start. Modes are available that allow the length of exposure time to be directly controlled by the ExFSTrig signal or to be set for a pre-programmed period of time.

Accumulated charges are read out of the sensor when exposure ends. The sensor can be read out in a four tap fashion or in a one tap fashion.



## 4.1.1 Four Tap Sensor Digitization Mode

With four tap sensor digitization, the sensor is divided into quadrants, and a separate electronic circuit is used to read out the pixels in each quadrant (see Figure 7 on [page 25](#)). Each of the electronic circuits used to read out a quadrant of the sensor is referred to as a tap. The advantage of the four tap digitization scheme is that it makes readout very fast because the four circuits are used simultaneously to read out the sensor.

After a image has been captured (i.e., exposure has ended), the pixels in the sensor become ready to be read out. At readout, the accumulated charges are transported from the pixels to the sensor's vertical shift registers. The charges from the top line of pixels in the array are then moved to the upper horizontal shift register and the charges from the bottom line of pixels are moved to the lower horizontal shift register as shown in Figure 7. Once this has been accomplished, the following operations are performed simultaneously:

- Charges from the left half of the top line are moved out of the upper horizontal shift register. The left half of the upper horizontal shift register shifts out charges from left to right, that is, pixel 1, pixel 2, pixel 3, and so on.
- Charges from the right half of the top line are moved out of the upper horizontal shift register. The right half of the upper horizontal shift register shifts out charges from right to left, that is, pixel n, pixel n-1, pixel n-2, and so on (where n is the last pixel in a line).
- Charges from the left half of the bottom line are moved out of the lower horizontal shift register. The left half of the lower horizontal shift register shifts out charges from left to right, that is, pixel 1, pixel 2, pixel 3, and so on.
- Charges from the right half of the bottom line are moved out of the lower horizontal shift register. The right half of the lower horizontal shift register shifts out charges from right to left, that is, pixel n, pixel n-1, pixel n-2, and so on (where n is the last pixel in a line).

As the charges move out of the horizontal shift registers, they are converted to voltages proportional to the size of each charge. Each voltage is then amplified by a Variable Gain Control (VGC) and digitized by an Analog-to-Digital converter (ADC). For optimal digitization, gain and black level can be adjusted by setting camera parameters.

After each voltage has been amplified and digitized, it passes through an FPGA and into an image buffer. All shifting of charges from the vertical to the horizontal registers and out of the horizontal registers is clocked according to the camera's internal data rate. Shifting continues until all image data has been read out of the sensor.

As the pixel data passes through the FPGA and into the buffer, it is reordered so that the pixel data for each line is in ascending order from pixel 1 through pixel n.

The pixel data leaves the image buffer and passes back through the FPGA to an Ethernet controller where it is assembled into data packets. The packets are then transmitted via an Ethernet network to a network adapter in the host computer. The Ethernet controller also handles transmission and receipt of control data such as changes to the camera's parameters.

The image buffer between the sensor and the Ethernet controller allows data to be read out of the sensor at a rate that is independent of the data transmission rate between the camera and the host computer. This ensures that the data transmission rate has no influence on image quality.

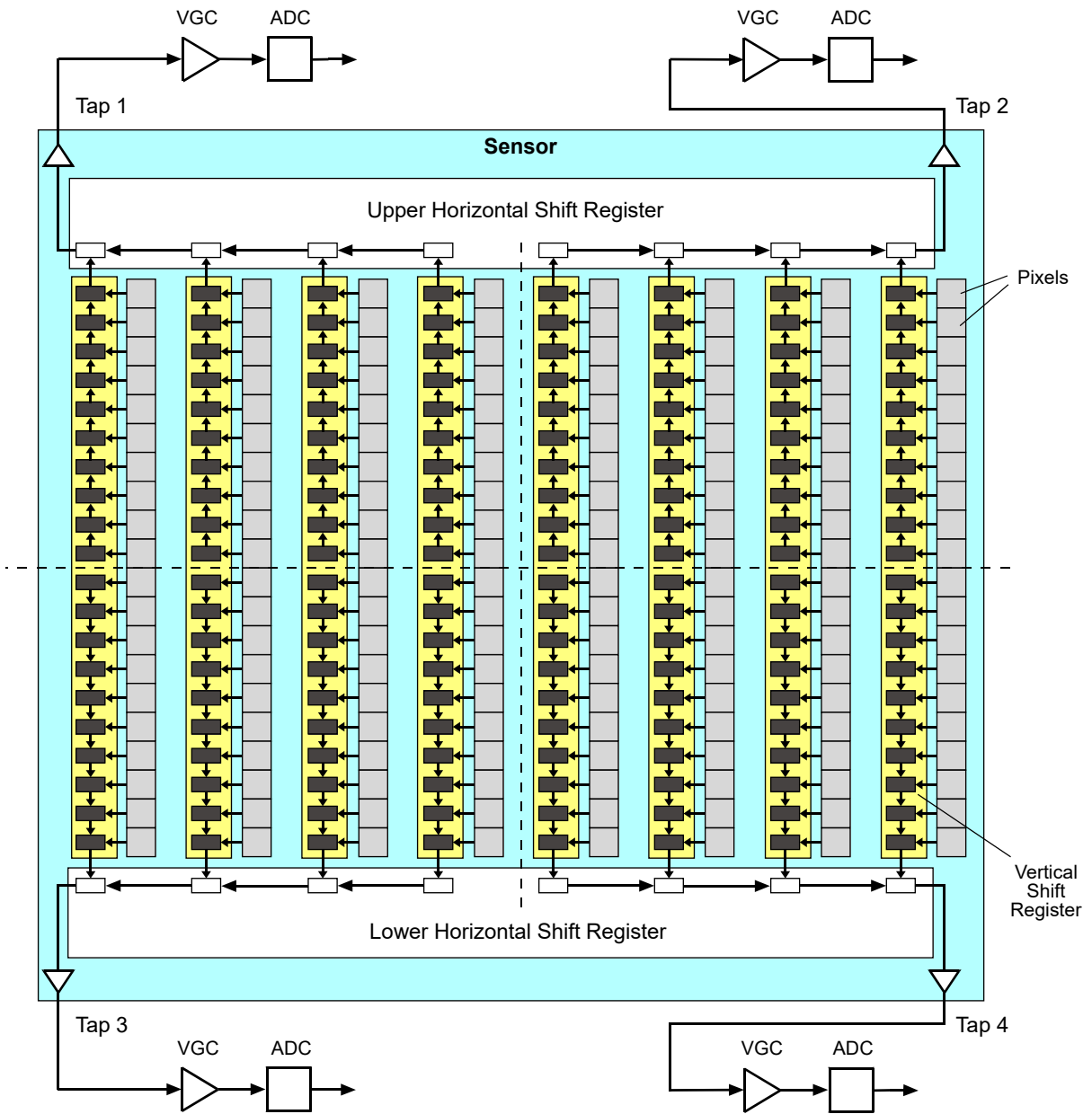

Fig. 7: Four Tap Sensor Readout Mode

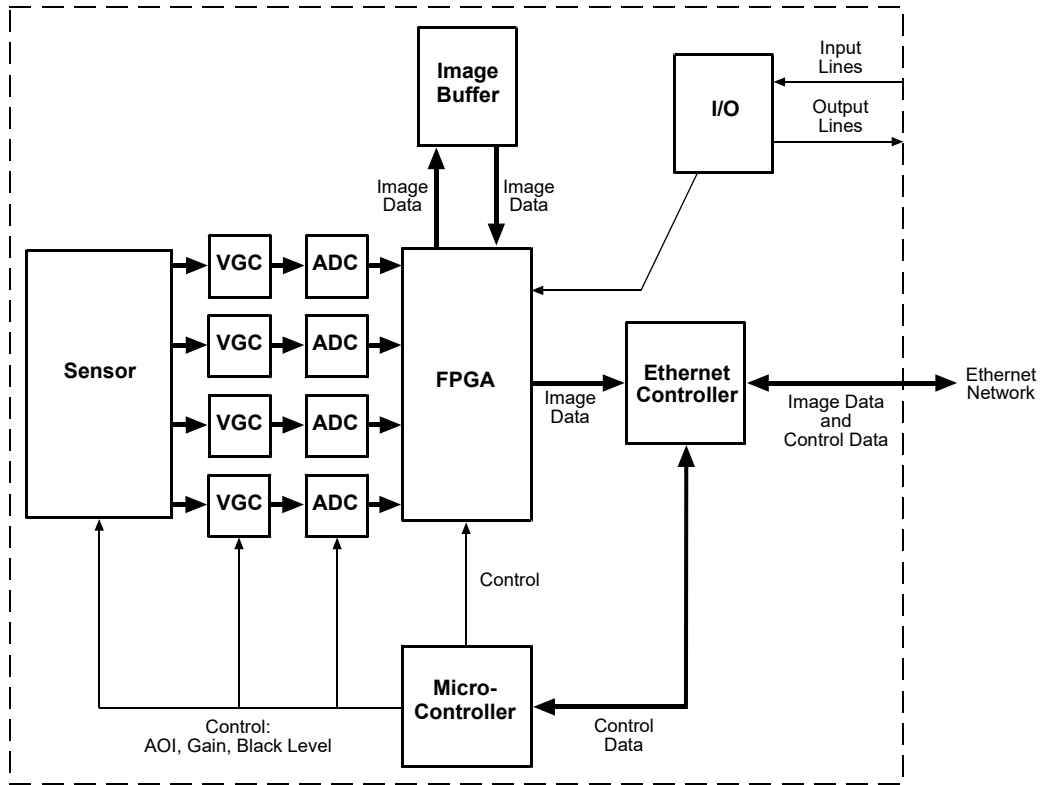

Fig. 8: Camera Block Diagram - Four Tap Mode

## 4.1.2 One Sensor Tap Digitization Mode

With one tap sensor digitization, only one electronic circuit is used to read out the pixels in the sensor (see Figure 9 on [page 28](#)). The advantage of the one tap digitization scheme is that it eliminates the need to balance four different readout circuits as is required with four tap readout. The drawback with one tap readout is that since it takes much longer to read out the sensor when using one tap, the camera's maximum achievable frame rate is limited.

After a image has been captured (i.e., exposure has ended), the pixels in the sensor become ready to be read out. At the start of readout, the charges accumulated during exposure are transported from the pixels to the sensor's vertical shift registers. The charges from the top line of pixels in the array are then moved to the upper horizontal shift register as shown in Figure 9.

Next, the charges are moved out of the upper horizontal shift register. As the charges move out of the horizontal shift register, they are converted to voltages proportional to the size of each charge. Each voltage is then amplified by a Variable Gain Control (VGC) and digitized by an analog-to-digital converter (ADC). For optimal digitization, gain and black level can be adjusted by setting camera parameters.

After each voltage has been amplified and digitized, it passes through an FPGA and into an image buffer. All shifting of charges from the vertical to the horizontal register and out of the horizontal register is clocked according to the camera's internal data rate. Shifting continues in a line-by-line fashion until all image data has been read out of the sensor.

The pixel data leaves the image buffer and passes back through the FPGA to an Ethernet controller where it is assembled into data packets. The packets are then transmitted via an Ethernet network to a network adapter in the host computer. The Ethernet controller also handles transmission and receipt of control data such as changes to the camera's parameters.

The image buffer between the sensor and the Ethernet controller allows data to be read out of the sensor at a rate that is independent of the data transmission rate between the camera and the host computer. This ensures that the data transmission rate has no influence on image quality.

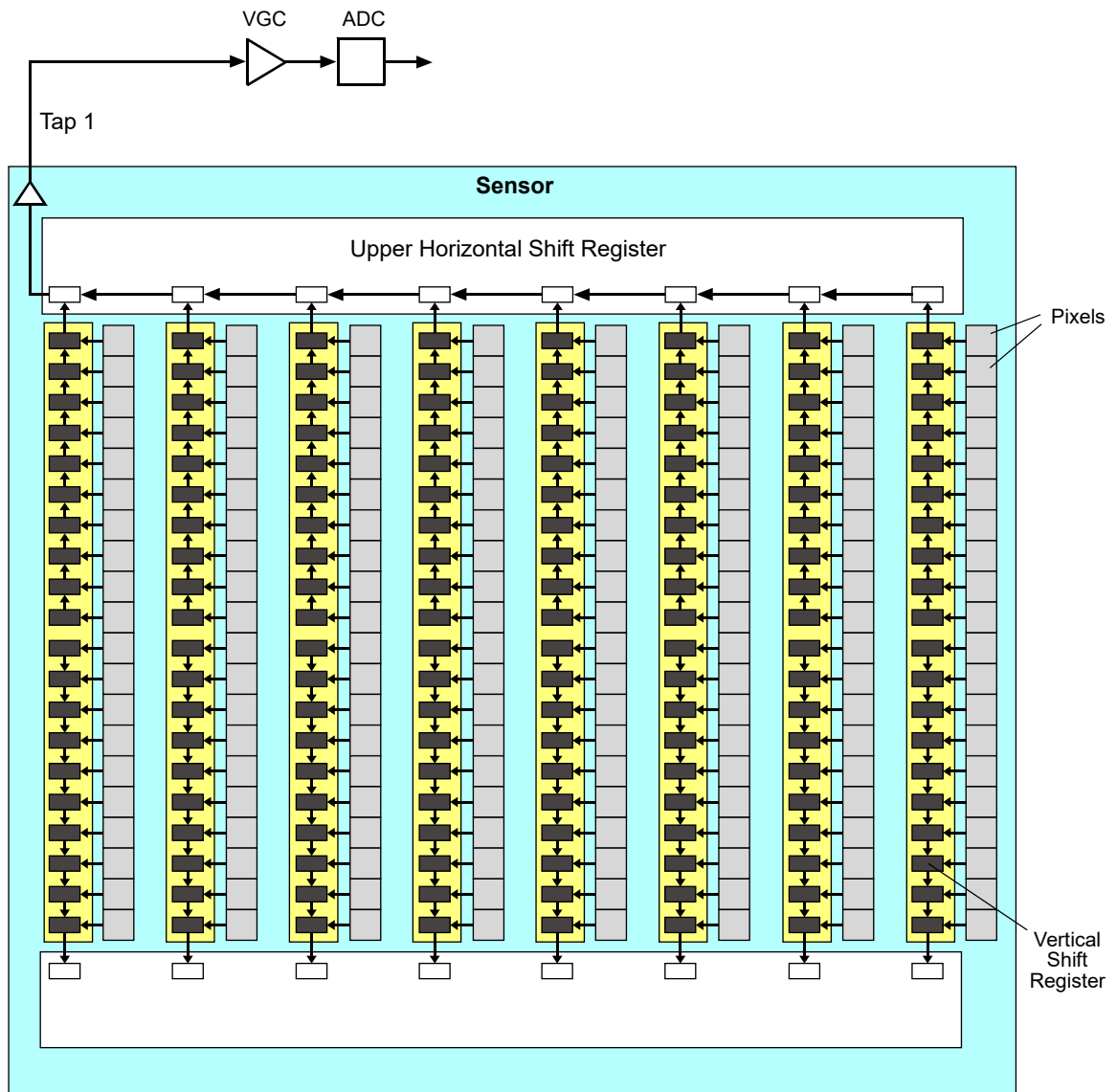

Fig. 9: One Tap Sensor Readout Mode

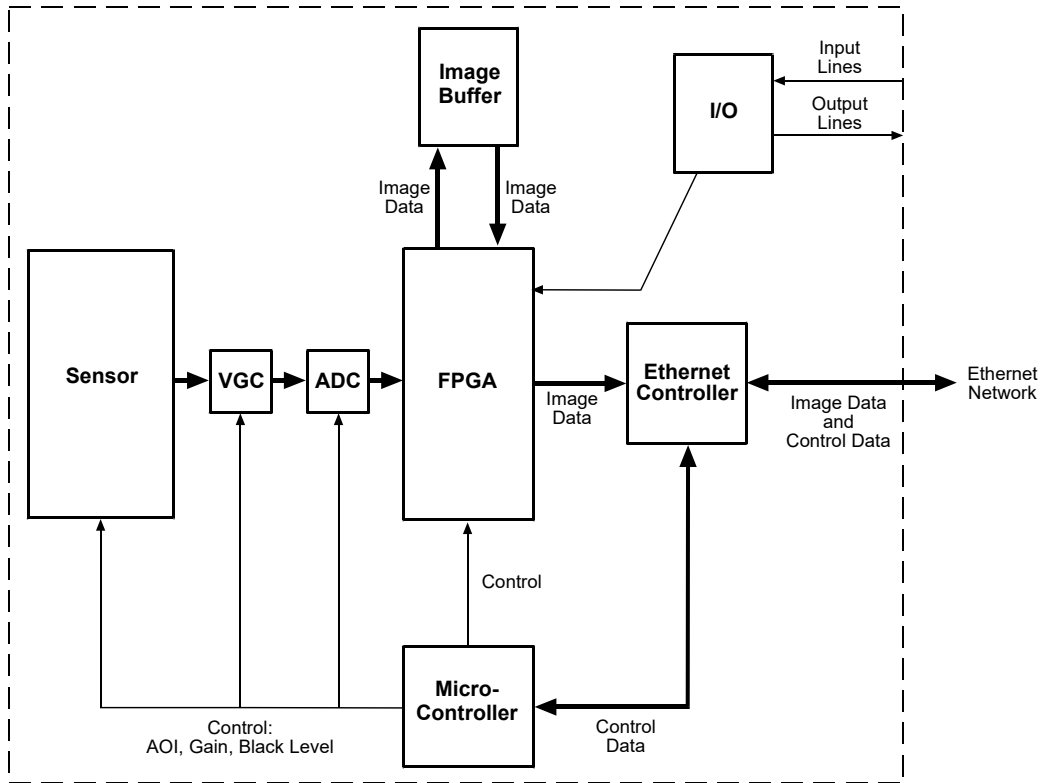

Fig. 10: Camera Block Diagram - One Tap Mode

# 5 Physical Interface

This chapter provides detailed information, such as assignments and voltage requirements, for the physical interface on the camera. This information especially useful during your initial design-in.



Note that separate power must be supplied:

- power to operate the camera ("camera power")
- power to operate inputs and output of the 12-pin receptacle.

## 5.1 General Description of the Camera Connections

The camera is interfaced to external circuitry via connectors located on the back of the housing:

- An 8-pin, RJ-45 jack used to provide a 100/1000 Mbit/s Ethernet connection to the camera. Pin assignments adhere to the Ethernet standard.
- A 12-pin receptacle used to provide camera power and power and access to the camera's I/O lines. The receptacle is a Hirose micro receptacle (part number HR10A-10R-12P) or the equivalent.

Figure 11 shows the location of the two connectors.

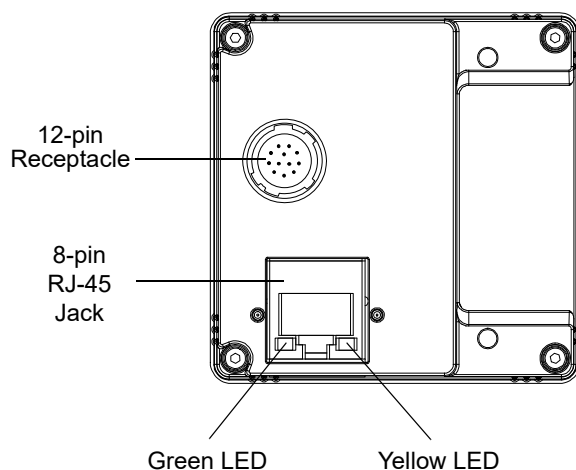

Fig. 11: Camera Connectors and LEDs

## 5.2 Camera Connector Pin Assignments and Numbering

### 5.2.1 12-Pin Receptacle

The 12 pin receptacle is used provide camera power as well as power and access to the two physical input lines and four physical output lines. The pin assignments and pin numbering for the receptacle are as shown in Table 2.



	Pin	Designation	Pin	Designation
		1	Camera Power Gnd *	7
	2	Camera Power Gnd *	8	Camera Power VCC **
	3	I/O Input 1	9	Camera Power VCC **
	4	I/O Input 2	10	I/O Output VCC
	5	I/O In Ground	11	I/O Output 3
	6	I/O Output 1	12	I/O Output 4

Table 2: Pin Assignments and Numbering for the 12-pin Receptacle

	<p>* Pins 1 and 2 are tied together inside of the camera.</p> <p>** Pins 8 and 9 are tied together inside of the camera.</p> <p>To avoid a voltage drop when there are long wires between your power supply and the camera, we recommend that you provide +12 VDC camera power through two separate wires between the power supply and pins 8 and 9 in the receptacle. We also recommend that you provide camera power ground through two separate wires between the power supply and pins 1 and 2.</p>
---	---

### 5.2.2 8-Pin RJ-45 Jack

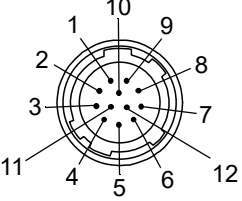
The 8-pin RJ-45 jack provides Ethernet access to the camera. Pin assignments adhere to the Ethernet standard.



## 5.3 Camera Cabling Requirements

### 5.3.1 Ethernet Cables

Suitable high-quality Ethernet cables terminated with horizontal screw-lock connectors are available from Basler.

Either a straight-through (patch) or a cross-over Ethernet cable can be used to connect the camera directly to a GigE network adapter in a computer or to a GigE network switch.

Close proximity to strong magnetic fields should be avoided.

### 5.3.2 Power-I/O Cable and Grounding

A single Power-I/O cable is used to supply camera power and power to the I/O lines.

The cable connects to the camera's 12-pin connector and carries

- camera power
- the I/O signals and
- power for the I/Os of the 12-pin connector (not to be confused with camera power).

Basler offers two types of the power and I/O cable:

- Power-I/O cable
- Power- I/O PLC+ cable.

The Power-I/O PLC+ cable is a variant of the Power-I/O cable. It is designed for use with devices where a logical zero is indicated by floating voltage or by undefined voltage above 1.4 VDC. This applies, for example, to PLC devices.

The Power-I/O PLC+ cable adjusts the logical zero voltages to more stable and correct voltages. The PLC I/O cable also improves the protection against negative voltage, reverse polarity, and EMI/ESD. See the Basler website for information about cable characteristics and how to obtain cables. In the downloads sections, you can find the related Technical Specifications.

Basler strongly recommends to keep the Power-I/O cable as short as possible and avoid close proximity to strong magnetic fields. The maximum cable length must not exceed 10 m. In practice, however, the maximum allowed cable length for your application can be distinctly shorter due to your specific operating conditions. For further information, contact your sales representative for advice about the optimum cable selection.

**NOTICE**

An incorrect plug can damage the 12-pin connector.

The plug on the cable that you attach to the camera's 12-pin connector must have 12 female pins. Using a plug designed for a smaller or a larger number of pins can damage the connector.

### 5.3.2.1 Grounding Recommendations

For proper EMI protection, the cable shields and their electrical contacts must be installed as shown in Figure 12. The cable shields must be connected to the camera housing via the camera's connectors. The cable shield for the camera power cable must also be connected to earth ground at the power supply.

Close proximity to strong magnetic fields should be avoided.

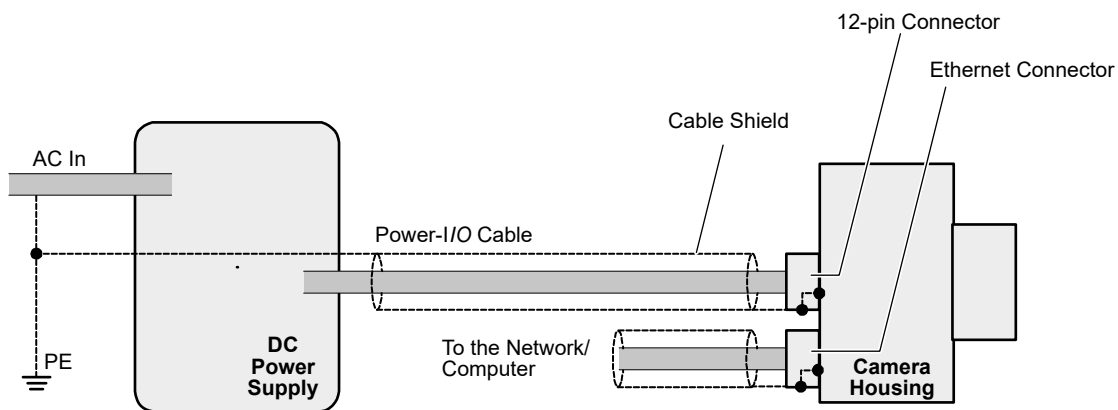

Fig. 12: Grounding Scheme for Camera, Cables, and Power Supply

**NOTICE**

To avoid a voltage drop when there are long wires between the power supply and the camera, Basler recommends that you provide to the following pins in the 12-pin connector:

- +12 VDC camera power through two separate wires between the power supply and pins 8 and 9
- I/O output power through a wire between the power supply and pins 10
- camera power ground through the separate wires between the power supply and pins 1, 2, and 5.
- I/O output ground through a wire between the power supply and pins 10.

For more information about applicable voltages, see Section on [page 33](#).

## 5.4 Camera Power

Camera power must be supplied to the 12-pin connector on the camera via the power-I/O cable from your power supply. Nominal operating voltage is +12 VDC ( $\pm 10\%$ ) with less than one percent ripple. Power consumption is as shown in the specification tables in Chapter 1 of this manual.

Close proximity to strong magnetic fields should be avoided.

### NOTICE

#### **Applying incorrect power can damage the camera.**

The camera's nominal operating voltage is +12 VDC ( $\pm 10\%$ ). If the voltage applied to the camera is greater than +13.2 VDC, severe damage to the camera can result. If the voltage is less than +10.8 VDC, the camera may operate erratically.

If the voltage is less than +10.8 VDC, the camera may operate erratically.

Applying power with the wrong polarity can result in severe damage to the camera.

1. Always make sure that the voltage of the camera power is within the specified range.
2. Always make sure that the polarity of the applied voltage is correct.

### NOTICE

#### **An incorrect plug can damage the camera's 12-pin connector.**

The plug on the cable that you attach to the camera's 12-pin connector must have 12 female pins. Using a plug designed for a smaller or a larger number of pins can damage the connector.

## 5.5 Ethernet GigE Device Information

The camera uses a standard Ethernet GigE transceiver. The transceiver is fully 100/1000 Base-T 802.3 compliant.

## 5.6 Input Line Description

The camera is equipped with two physical input lines designated as I/O Input 1 (input line 1) and I/O Input 2 (input line 2). The input lines are accessed via the 12-pin receptacle on the back of the camera.

### 5.6.1 Voltage and Current Requirements

The following voltages apply **at the camera's I/O input pins** (pins 3 and 4 of the 12-pin receptacle). The same voltages apply to cable input power for the Power-I/O cable.

Voltage	Significance
+0 to +24 VDC	Operating voltage.
+0 to +1.4 VDC	The voltage indicates a logical 0.
> +1.4 to +2.2 VDC	Region where the transition threshold occurs; the logical state is not defined in this region.
> +2.2 VDC	The voltage indicates a logical 1.

Table 3: Voltage Requirements for the I/O Inputs When Using the Standard I/O Cable

The current draw for each input line is between 5 and 15 mA.

## 5.6.2 Circuit Diagram

The camera is equipped with two physical input lines designated as input line 1 and input line 2. The input lines are accessed via the 12-pin receptacle on the back of the camera.

As shown in the I/O line schematic, each input line is opto-isolated. See the Voltage Requirements section for recommended input voltages and their significances.

Figure 13 shows an example of a typical circuit you can use to input a signal into the camera.

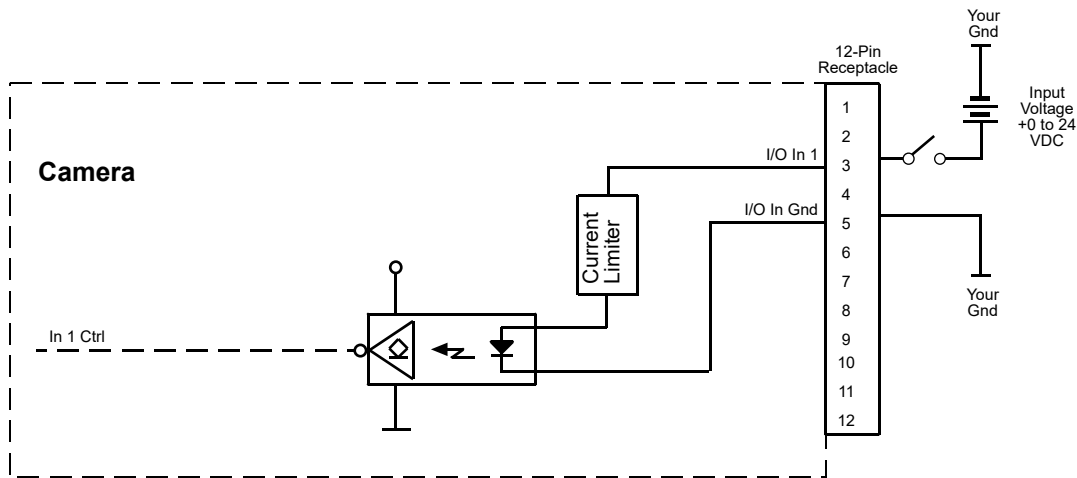

Fig. 13: Typical Input Circuit (Simplified)

For more information about

- input line pin assignments and pin numbering, see Section 5.2 on [page 31](#).
- the delays between transition of a frame trigger and the begin of exposure ("exposure start delay"), see Table 6 on [page 91](#).
- selecting the input lines, see Section 6.1 on [page 41](#).

### 5.6.3 Assigning an Input Line to Receive a Hardware Trigger Signal

You can assign input line 1 or input line 2 to receive a hardware trigger signal for the following functions:

- the acquisition start trigger
- the frame start trigger
- the frame counter reset
- the trigger input counter reset

Note that when an input line has been selected as the source signal for a camera function, you must apply an electrical signal to the input line that is appropriately timed for the function.

For more information about assigning input line 1 or input line 2 to receive a hardware trigger signal, see Section 6.1 on [page 41](#).

## 5.7 Output Line Description

The camera is equipped with four physical output lines designated as Output 1 (output line 1) through I/O Output 4 (output line 4). The output lines are accessed via the 12-pin receptacle on the back of the camera.

### 5.7.1 Voltage Requirements

The following voltage requirements apply to the I/O output VCC (pin 10 of the 12-pin receptacle):

Voltage	Significance
< +3.3 VDC	The I/O outputs may operate erratically.
+3.3 to +24 VDC	Operating voltage.

Table 4: Voltage Requirements for the I/O Output VCC

**The maximum current allowed through an output circuit is 50 mA.**

### 5.7.2 Circuit Diagram

The camera is equipped with four physical output lines designated as Output 1 (output line 1) through I/O Output 4 (output line 4). The output lines are accessed via the 12-pin receptacle on the back of the camera.

As shown in the I/O circuit diagram, each output line is opto-isolated. See the Voltage Requirements section for the recommended operating voltage.

A logical zero on Out X Ctrl results in a non-conducting transistor Q in the Output Line X circuit, where X = the number of an output line. For example, a logical zero on Out 1 Ctrl results in a non-conducting transistor Q in the Output Line 1 circuit.

A logical one on Out X Ctrl results in a conducting transistor Q in the Output Line X circuit, where X equals the number of an output line. For example, a logical one on Out 1 Ctrl results in a conducting transistor Q in the Output Line 1 circuit.

Figure 14 shows a typical circuit you can use to monitor the output line with a voltage signal.

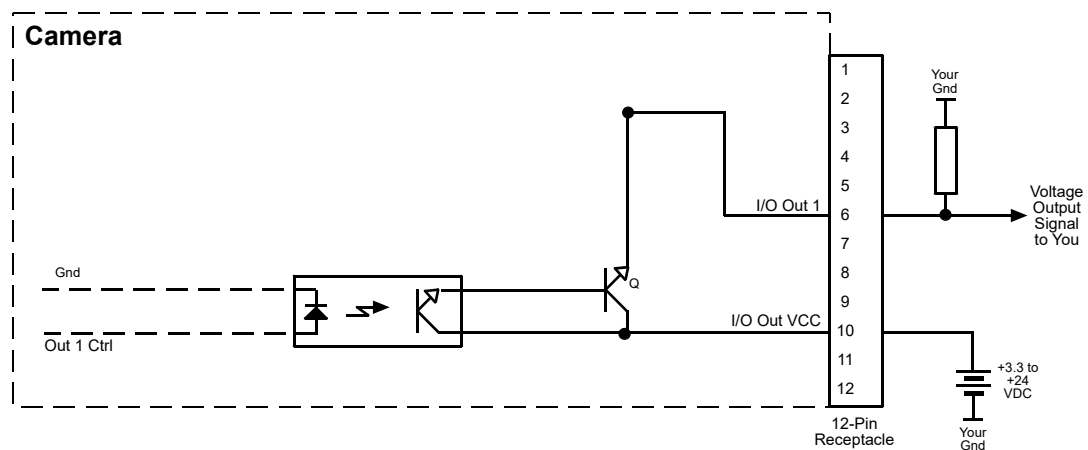

Fig. 14: Typical Voltage Output Circuit (Simplified)

Figure 15 shows a typical circuit you can use to monitor an output line with an LED or an optocoupler. In this example, the voltage for the external circuit is +24 VDC. Current in the circuit is limited by an external resistor.

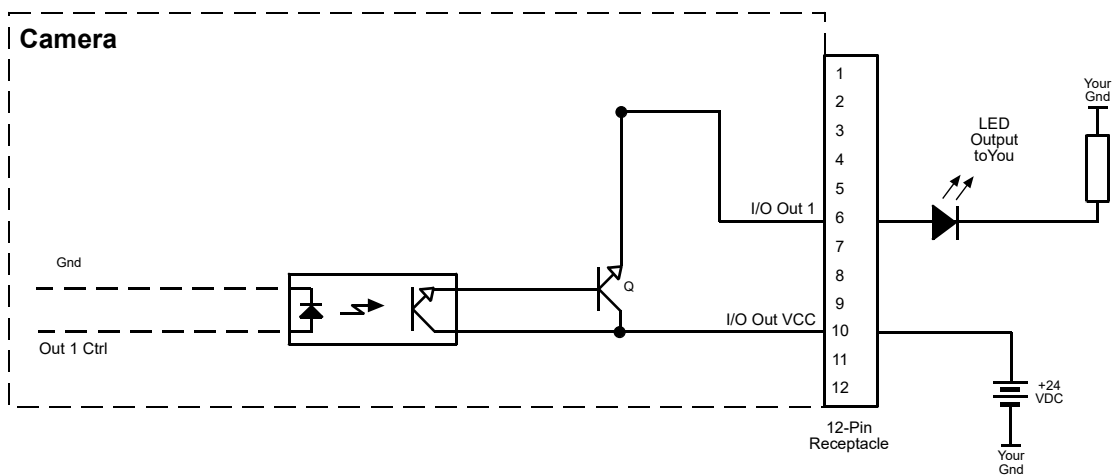

Fig. 15: Typical LED Output Signal (Simplified)

For more information about

- output line pin assignments and pin numbering, see Section 5.2 on [page 31](#).
- configuring the output lines, see Section 5.7.4 on [page 40](#).



### 5.7.3 Response Times

Response times for the output lines on the camera are as shown in Figure 16.

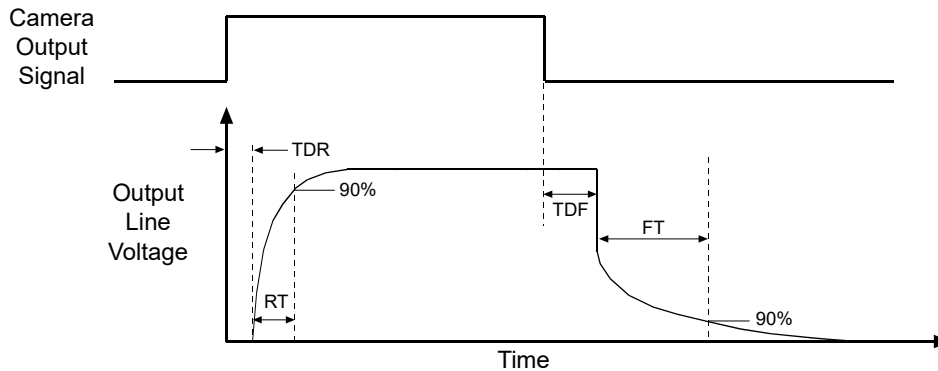

Fig. 16: Output Line Response Times

Time Delay Rise (TDR) = 1.5  $\mu$ s (typical)

Rise Time (RT) = 1.0 - 2.0  $\mu$ s (typical)

Time Delay Fall (TDF) = 40  $\mu$ s (typical)

Fall Time (FT) = 5 - 10  $\mu$ s (typical)



The response times for the output lines on your camera will typically fall into the ranges specified above. The exact response time for your specific application will depend on the external resistor and the applied voltage you use.

### 5.7.4 Assigning a Camera Output Signal to an Output Line

To make a physical output line useful, you must select a source signal for the output line. The camera has several standard output signals available and each signal can be selected as the source signal for an output line.

For more information about assigning a camera output signal to an output line, see [Section 6.2 on page 45](#).

# 6 I/O Control

This section describes how to configure the camera's two physical input lines and four physical output lines. It also provides information about monitoring the state of the input and output lines.

## 6.1 Configuring the Input Lines

### 6.1.1 Assigning an Input Line to Receive a Hardware Trigger Signal

The camera is equipped with two physical input lines designated as input line 1 and input line 2. You can assign a camera input line to act as the source signal for the following camera functions:

- Acquisition Start Trigger - If an input line is selected to be the source signal for the acquisition start trigger, whenever a proper electrical signal is applied to the line, the camera will recognize the signal as an acquisition start trigger signal.
- Frame Start Trigger - If an input line is selected to be the source signal for the frame start trigger, whenever a proper electrical signal is applied to the line, the camera will recognize the signal as a frame start trigger signal.
- Frame Counter Reset - If an input line is selected to be the source signal for the frame counter reset, whenever a proper electrical signal is applied to the line, the counter value for the frame counter chunk feature will be reset.
- Trigger Input Counter Reset - If an input line is selected to be the source signal for the trigger input counter reset, whenever a proper electrical signal is applied to the line, the counter value for the trigger reset counter chunk feature will be reset.

For detailed information about assigning an input line to act as the source signal

- for the acquisition start trigger and for details about how the acquisition start trigger operates, see Section 7.3.5 on [page 68](#).
- for the frame start trigger and for details about how the acquisition start trigger operates, see Section 7.4.3 on [page 77](#).
- for a frame counter reset and for details about how the frame counter chunk feature operates, see Section 11.3 on [page 258](#).
- for a trigger input counter reset and for details about how the trigger input counter chunk feature operates, see Section 11.5 on [page 262](#).

For more information about the electrical characteristics of the input lines, see Section 5.6 on [page 35](#).



By default, input line 1 is selected as the source signal for the frame start trigger and input line 2 is selected as the source signal for the acquisition start trigger.

## 6.1.2 Input Line Debouncer

The Line Debouncer feature allows you to filter invalid hardware input signals. Only valid signals are allowed to pass through to the camera and become effective.

### Prerequisites

The camera must be configured for hardware triggering.

### How It Works

The line debouncer filters out unwanted short signals (contact bounce) from the rising and falling edges of incoming hardware trigger signals. The line debouncer employs a clock and evaluates all changes and durations of logical states of hardware signals to distinguish between valid and invalid signals.

The maximum duration of this evaluation period (the "line debouncer time") is defined by the `LineDebouncerTimeAbs` parameter.

The clock starts counting whenever a hardware signal changes its logical state (high to low or vice versa). If the duration of the new logical state is shorter than the line debouncer time specified, the new logical state is considered invalid and has no effect. If the duration of the new logical state is as long as the line debouncer time or longer, the new logical state is considered valid and is allowed to become effective in the camera.

Default value: 10  $\mu$ s



Specifying a line debouncer time introduces a delay between a valid trigger signal arriving at the camera and the moment the related change of logical state is passed on to the camera. The duration of the delay is at least equal to the value of the `LineDebouncerTimeAbs` parameter. This is because the camera waits for the time specified as the line debouncer time to determine whether the signal is valid.

Figure 17 illustrates how the line debouncer filters out invalid signals from the rising and falling edge of a hardware trigger signal. Line debouncer times that actually allow a change of logical state in the camera are labeled "OK". Also illustrated are the delays of logical states inside the camera relative to the hardware trigger signal.

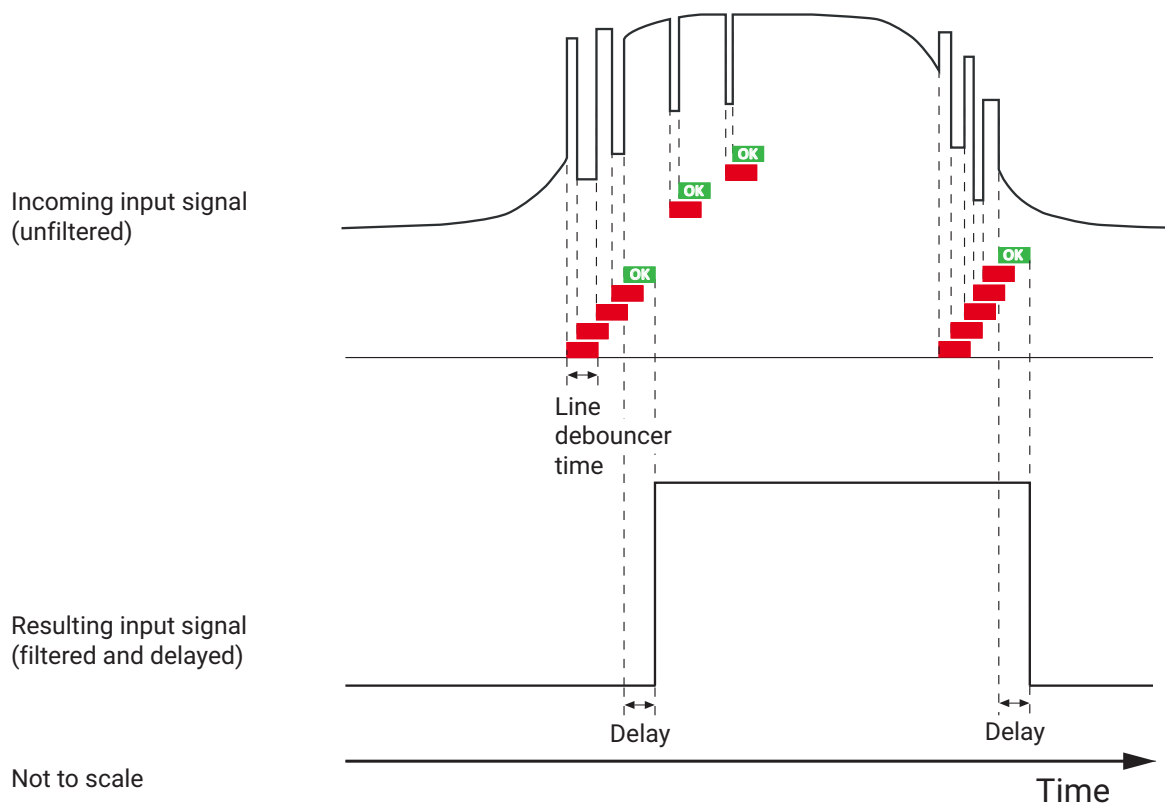

Fig. 17: Filtering of Invalid Hardware Signals by the Debouncer

## Setting the Input Debouncer

The debouncer value on each line is determined by the value of the `LineDebouncerTimeAbs` parameter value. The parameter is set in microseconds and can be set in a range from 0 to approximately 20 ms.

To set the debouncer on an input line:

- Use the Line Selector to select an input line.
- Set the value of the `LineDebouncerTimeAbs` parameter.

You can set the Line Selector and the value of the `LineDebouncerTimeAbs` parameter from within your application software by using the Basler pylon API. The following code snippet illustrates using the API to set the selector and the parameter value:

```
// Select the input line
Camera.LineSelector.SetValue( LineSelector_Line1 );

// Set the parameter value to 100 microseconds
Camera.LineDebouncerTimeAbs.SetValue( 100 );
```

You can also use the Basler pylon Viewer application to easily set the parameters.

For more information about the pylon API and the pylon Viewer, see Section 3 on [page 21](#).

## 6.1.3 Using an Unassigned Input Line to Receive a User Input Signal

You can use an unassigned input line to receive your own, user-generated input signal. The electrical characteristics of your input signal must meet the requirements shown in the Physical Interface section of this manual.

You can use the Line Status or Line Status All parameters to monitor the state of the input line that is receiving the user-defined signal.



A line assigned to receive an ExTrig input signal can't be used to receive a user-designed input signal.

For more information about using the Line Status and Line Status All parameters, see Section 6.3.1 on [page 54](#) and Section 6.3.2 on [page 54](#).

## 6.1.4 Setting an Input Line for Invert

### Setting an Input Line for Invert Using Basler pylon

You can set each individual input line to invert or not to invert the incoming electrical signal. To set the invert function on an input line:

- Use the Line Selector to select an input line.
- Set the value of the Line Inverter parameter to true to enable inversion on the selected line and to false to disable inversion.

You can set the Line Selector and the Line Inverter parameter value from within your application software by using the pylon API. The following code snippet illustrates using the API to set the selector and the parameter value:

```
// Enable the inverter on line 1
Camera.LineSelector.SetValue( LineSelector_Line1 );
Camera.LineInverter.SetValue( true );
```

For detailed information about using the pylon API, refer to the Basler pylon Programmer's Guide and API Reference.

You can also use the Basler pylon Viewer application to easily set the parameters.

## 6.2 Configuring Output Lines

### 6.2.1 Assigning a Camera Output Signal to an Output Line

The camera is equipped with four output lines designated as output line 1, output line 2, output line 3, and output line 4. You can use the camera's output signal selection capability to select one of the camera's standard output signals as the source signal for a physical output line. The camera has several standard output signals available including:

- Acquisition Trigger Wait
- Frame Trigger Wait
- Exposure Active
- Timer Active

You can also designate an output line as "user settable". If an output line is designated as user settable, you can use the camera's API to set the state of the line as desired.

To select a source signal for an output line or to designate the line as user settable:

- Use the Line Selector to select an output line.
- Set the value of the Line Source Parameter to one of the available output signals or to user settable.



By default,

- the Exposure Active signal is assigned to output line 1
- the Frame Trigger Wait signal is assigned to output line 2
- the Timer Active signal is assigned to output line 3
- the User Output signal is assigned to output line 4.

You can set the Line Selector and the Line Source parameter value from within your application software by using the Basler pylon API. The following code snippet illustrates using the API to set the selector and the parameter value:

```
//Set the source signal for output line 1
Camera.LineSelector.SetValue( LineSelector_Out1 );
Camera.LineSource.SetValue( LineSource_ExposureActive );

//Set the source signal for output line 2
Camera.LineSelector.SetValue( LineSelector_Out2 );
Camera.LineSource.SetValue( LineSource_FrameTriggerWait );

//Set the source signal for output line 3
```

```
Camera.LineSelector.SetValue( LineSelector_Out3 );  
Camera.LineSource.SetValue( LineSource_TimerActive );
```

You can also use the Basler pylon Viewer application to easily set the parameters.

For more information about

- the pylon API and the pylon Viewer, see Section 3 on [page 21](#).
- the acquisition trigger wait signal, see Section 7.7.3.1 on [page 87](#).
- the frame trigger wait signal, see Section 7.7.3.2 on [page 89](#).
- the exposure active signal, see Section 7.7.1 on [page 85](#).
- working with a timer output signal, see Section 6.2.4 on [page 49](#).
- setting the state of a user settable output line, see Section 6.2.2 on [page 47](#).
- the electrical characteristics of the output lines, see Section 5.7 on [page 38](#).

## 6.2.2 Setting the State of a User Settable Output Line

As mentioned in the previous section, you can designate an output line as "user settable". If you have designated an output line as user settable, you can use camera parameters to set the state of the line.

### Setting the State of a User Settable Output Line

To set the state of a user settable output line:

- Use the User Output Selector to select the output line.
- Set the value of the User Output Value parameter to true (1) or false (0). This will set the state of the output line.

You can set the Output Selector and the User Output Value parameters from within your application software by using the Basler pylon API. The following code snippet illustrates using the API to designate the output line as user settable and to set the state of the output line:

```
// Set output line 1 to user settable
Camera.LineSelector.SetValue( LineSelector_Out1 );
Camera.LineSource.SetValue( LineSource_UserOutput );
// Set the state of output line 1
Camera.UserOutputSelector.SetValue( UserOutputSelector_UserOutput1 );
Camera.UserOutputValue.SetValue( true );
bool currentUserOutput1State = Camera.UserOutputValue.GetValue( );
```

You can also use the Basler pylon Viewer application to easily set the parameters.



If you have the invert function enabled on the output line and the line is designated as user settable, the user setting sets the state of the line before the inverter.

For more information about the pylon API and the pylon Viewer, see Section 3 on [page 21](#).



## 6.2.3 Setting an Output Line for Invert

You can set an output line to not invert or to invert.

When an output line is set to not invert:

- A logical zero on Out\_X\_Ctrl results in a non-conducting transistor Q in the output circuit (where X is the output number).
- A logical one on Out\_X\_Ctrl results in a conducting transistor Q in the output circuit.

For example in Figure 18, a logical zero on Out\_1\_Ctrl results in a non-conducting transistor Q in the line 1 output circuit, and a logical one results in a conducting transistor Q.

When the output line is set to invert:

- A logical zero on Out\_X\_Ctrl results in a conducting transistor Q in the output circuit.
- A logical one on Out\_X\_Ctrl results in a non-conducting transistor Q in the output circuit.

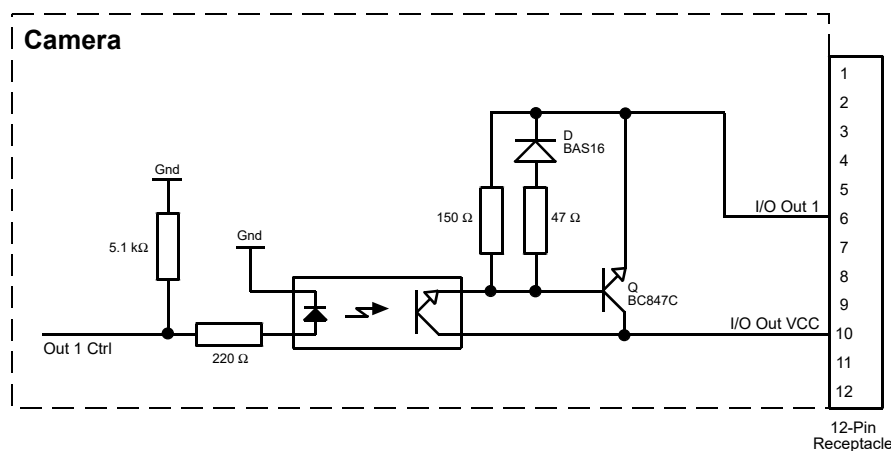

Fig. 18: Output Line Schematic for Line 1

To set the invert function on an output line:

- Use the Line Selector to select the output line.
- Set the value of the Line Inverter parameter to true to enable inversion on the selected line or to false to disable inversion.

You can set the Line Selector and the Line Inverter parameter values from within your application software by using the Basler pylon API. The following code snippet illustrates using the API to set the selector and the parameter value:

```
// Enable the inverter on output line 1
Camera.LineSelector.SetValue( LineSelector_Out1 );
Camera.LineInverter.SetValue( true );
```

You can also use the Basler pylon Viewer application to easily set the parameters.

For more information about the pylon API and the pylon Viewer, see Section 3 on [page 21](#).

## 6.2.4 Working with the Timer Output Signals

As mentioned in Section 6.2.1 on [page 45](#), the source signal for each output line can be set to "timer active". The camera has four timers: timer 1, timer 2, timer 3, and timer 4. When you set the source signal for an output line to "timer active", the correspondingly numbered timer will be used to supply the signal to the output line. For example, if you decide that you want to use "timer active" as the source signal for output line 3, then timer 3 will supply the source signal for the output.

The timer output signals all operate in an identical fashion. They operate as follows:

- A trigger source event occurs that starts the timer.
- A delay period begins to expire.
- When the delay expires, the timer signal goes high and a duration period begins to expire.
- When the duration period expires, the timer signal goes low.

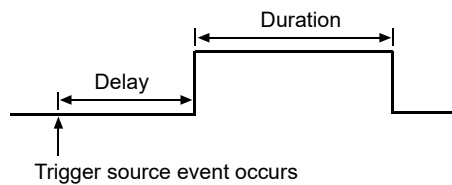

Fig. 19: Timer Signal

Currently, the only trigger source event available to start the timer is "exposure start". In other words, you can use exposure start to trigger the start of the timer.

If you require the timer signal to be high when the timer is triggered and to go low when the delay expires, simply set the output line to invert.

### 6.2.4.1 Setting the Trigger Source for a Timer

To set the trigger source for a timer:

- Use the Timer Selector to select the timer.
- Set the value of the Timer Trigger Source parameter to exposure active. This will set the selected timer to use the start of exposure to begin the timer.

You can set the Trigger Selector and the Timer Trigger Source parameter value from within your application software by using the Basler pylon API. The following code snippet illustrates using the API to set the selector and the parameter value for timer 1:

```
Camera.TimerSelector.SetValue( TimerSelector_Timer1 );
Camera.TimerTriggerSource.SetValue( TimerTriggerSource_ExposureStart );
```

You can also use the Basler pylon Viewer application to easily set the parameters.

For more information about the pylon API and the pylon Viewer, see Section 3 on [page 21](#).

## 6.2.4.2 Setting a Timer Delay Time

There are two ways to set the delay time for a timer: by setting "raw" values or by setting an "absolute value". You can use whichever method you prefer to set the delay time.

### Setting the Delay Time with Raw Values

When the delay time for a timer is set using "raw" values, the delay time will be determined by a combination of two elements. The first element is the value of the Timer Delay Raw parameter, and the second element is the Timer Delay Time Base. The delay time is the product of these two elements:

Delay Time = (Timer Delay Raw Parameter Value) x (Timer Delay Time Base)

By default, the Timer Delay Time Base is fixed at 1  $\mu$ s. Typically, the delay time is adjusted by setting the Timer Delay Raw parameter value.

The Timer Delay Raw parameter value can range from 0 to 4095. So if the value is set to 100, for example, the timer delay will be 100 x 1  $\mu$ s or 100  $\mu$ s.

To set the delay for a timer:

- Use the Timer Selector to select a timer.
- Set the value of the Timer Delay Raw parameter.

You can set the Timer Selector and the Timer Delay Raw parameter value from within your application software by using the pylon API. The following code snippet illustrates using the API to set the selector and the parameter value for timer 1:

```
Camera.TimerSelector.SetValue( TimerSelector_Timer1 );  
Camera.TimerDelayRaw.SetValue( 100 );
```

You can also use the Basler pylon Viewer application to easily set the parameters.

### Changing the Delay Time Base

By default, the Timer Delay Time Base is fixed at 1  $\mu$ s (minimum value), and the timer delay is normally adjusted by setting the value of the Timer Delay Raw parameter. However, if you require a delay time that is longer than what you can achieve by changing the value of the Timer Delay Raw parameter alone, the Timer Delay Time Base Abs parameter can be used to change the delay time base.

The Timer Delay Time Base Abs parameter value sets the delay time base in  $\mu$ s. The default is 1  $\mu$ s and it can be changed in 1  $\mu$ s increments.

Note that there is only one timer delay time base and it is used by all four of the available timers.

You can set the Timer Delay Time Base Abs parameter value from within your application software by using the pylon API. The following code snippet illustrates using the API to set the parameter value:

```
Camera.TimerDelayTimebaseAbs.SetValue( 5 );
```

You can also use the Basler pylon Viewer application to easily set the parameters.

For more information about the pylon API and the pylon Viewer, see Section 3 on [page 21](#).

## Setting the Delay Time with an Absolute Value

You can also set the delay time for a timer by using an "absolute" value. This is accomplished by setting the Timer Delay Abs parameter. The units for setting this parameter are  $\mu\text{s}$  and the value can be set in increments of 1  $\mu\text{s}$ .

To set the delay for a timer using an absolute value:

- Use the Timer Selector to select a timer.
- Set the value of the Timer Delay Abs parameter.

You can set the Timer Selector and the Timer Delay Abs parameter value from within your application software by using the pylon API. The following code snippet illustrates using the API to set the selector and the parameter value for timer 1:

```
Camera.TimerSelector.SetValue( TimerSelector_Timer1 );  
Camera.TimerDelayAbs.SetValue( 100 );
```

When you use the Timer Delay Abs parameter to set the delay time, the camera accomplishes the setting change by automatically changing the Timer Delay Raw parameter to achieve the value specified by the Timer Delay Abs setting. This leads to a limitation that you must keep in mind if you use Timer Delay Abs parameter to set the delay time. That is, you must set the Timer Delay Abs parameter to a value that is equivalent to a setting you could achieve by using the Timer Delay Raw and the current Timer Delay Base parameters. For example, if the time base was currently set to 50  $\mu\text{s}$ , you could use the Timer Delay Abs parameter to set the delay to 50  $\mu\text{s}$ , 100  $\mu\text{s}$ , 150  $\mu\text{s}$ , etc.

Note that if you set the Timer Delay Abs parameter to a value that you could not achieve by using the Timer Delay Raw and current Timer Delay Time Base parameters, the camera will automatically change the setting for the Timer Delay Abs parameter to the nearest achievable value.

You should also be aware that if you change the delay time using the raw settings, the Timer Delay Abs parameter will automatically be updated to reflect the new delay time.

### 6.2.4.3 Setting the Timer Duration Time

There are two ways to set the duration time for a timer: by setting "raw" values or by setting an "absolute value". You can use whichever method you prefer to set the duration time.

#### Setting the Duration Time with Raw Values

When the duration time for a timer is set using "raw" values, the duration time will be determined by a combination of two elements. The first element is the value of the Timer Duration Raw parameter, and the second element is the Timer Duration Time Base. The duration time is the product of these two elements:

$$\text{Duration Time} = (\text{Timer Duration Raw Parameter Value}) \times (\text{Timer Duration Time Base})$$

By default, the Timer Duration Time Base is fixed at 1  $\mu\text{s}$ . Typically, the duration time is adjusted by setting only the Timer Duration Raw parameter value.

The Timer Duration Raw parameter value can range from 1 to 4095. So if the value is set to 100, for example, the timer duration will be 100 x 1  $\mu\text{s}$  or 100  $\mu\text{s}$ .

To set the duration for a timer:

- Use the Timer Selector to select a timer.
- Set the value of the Timer Duration Raw parameter.

You can set the Timer Selector and the Timer Duration Raw parameter value from within your application software by using the pylon API. The following code snippet illustrates using the API to set the selector and the parameter value for timer 1:

```
Camera.TimerSelector.SetValue( TimerSelector_Timer1 );  
Camera.TimerDurationRaw.SetValue( 100 );
```

You can also use the Basler pylon Viewer application to easily set the parameters.

#### Changing the Duration Time Base

By default, the Timer Duration Time Base is fixed at 1  $\mu\text{s}$ , and the timer duration is normally adjusted by setting the value of the Timer Duration Raw parameter. However, if you require a duration time that is longer than what you can achieve by changing the value of the Timer Duration Raw parameter alone, the Timer Duration Time Base Abs parameter can be used to change the duration time base.

The Timer Duration Time Base Abs parameter value sets the duration time base in  $\mu\text{s}$ . The default is 1  $\mu\text{s}$  and it can be changed in 1  $\mu\text{s}$  increments.

Note that there is only one timer duration time base and it is used by all four of the available timers.

You can set the Timer Duration Time Base Abs parameter value from within your application software by using the pylon API. The following code snippet illustrates using the API to set the parameter value:

```
Camera.TimerDurationTimebaseAbs.SetValue( 5 );
```

For more information about the pylon API and the pylon Viewer, see Section 3 on [page 21](#).

## Setting the Timer Duration with an Absolute Value

You can also set the duration for a timer by using an "absolute" value. This is accomplished by setting the Timer Duration Abs parameter. The units for setting this parameter are  $\mu\text{s}$  and the value can be set in increments of 1  $\mu\text{s}$ .

To set the duration for a timer using an absolute value:

- Use the Timer Selector to select a timer.
- Set the value of the Timer Duration Abs parameter.

You can set the Timer Selector and the Timer Duration Abs parameter value from within your application software by using the pylon API. The following code snippet illustrates using the API to set the selector and the parameter value for timer 1:

```
Camera.TimerSelector.SetValue( TimerSelector_Timer1 );  
Camera.TimerDurationAbs.SetValue( 100 );
```

When you use the Timer Duration Abs parameter to set the duration time, the camera accomplishes the setting change by automatically changing the Timer Duration Raw parameter to achieve the value specified by the Timer Duration Abs setting. This leads to a limitation that you must keep in mind if you use Timer Duration Abs parameter to set the duration time. That is, you must set the Timer Duration Abs parameter to a value that is equivalent to a setting you could achieve by using the Timer Duration Raw and the current Timer Duration Base parameters. For example, if the time base was currently set to 50  $\mu\text{s}$ , you could use the Timer Duration Abs parameter to set the duration to 50  $\mu\text{s}$ , 100  $\mu\text{s}$ , 150  $\mu\text{s}$ , etc.

If you read the current value of the Timer Duration Abs parameter, the value will indicate the product of the Timer Duration Raw parameter and the Timer Duration Time Base. In other words, the Timer Duration Abs parameter will indicate the current duration time setting.

You should also be aware that if you change the duration time using the raw settings, the Timer Duration Abs parameter will automatically be updated to reflect the new duration time.

## 6.3 Checking the State of the I/O Lines

### 6.3.1 Checking the State of a Single Line

You can determine the current state of any one of the camera's I/O lines. To check the state of a line:

- Use the Line Selector parameter to select a line.
- Read the value of the Line Status parameter to determine the current state of the line. A value of true means the line's state is currently high and a value of false means the line's state is currently low.

You can set the Line Selector and read the Line Status parameter value from within your application software by using the Basler pylon API. The following code snippet illustrates using the API to set the selector and read the parameter value:

```
// Select output line 1 and read the state
Camera.LineSelector.SetValue( LineSelector_Out1 );
bool outputLine1State = Camera.LineStatus.GetValue( );
```

You can also use the Basler pylon Viewer application to easily set the parameters.

For more information about the pylon API and the pylon Viewer, see Section 3 on [page 21](#).

### 6.3.2 Checking the State of All Lines

You can determine the current state of all input and output lines with a single operation. To check the state of all lines:

Read the value of the Line Status All parameter.

You can read the Line Status All parameter value from within your application software by using the pylon API. The following code snippet illustrates using the API to read the parameter value:

```
int64_t lineState = Camera.LineStatusAll.GetValue( );
```

The Line Status All parameter is a 32 bit value. As shown in Figure 20, certain bits in the value are associated with each line, and the bits will indicate the state of the lines. If a bit is 0, it indicates that the state of the associated line is currently low. If a bit is 1, it indicates that the state of the associated line is currently high.

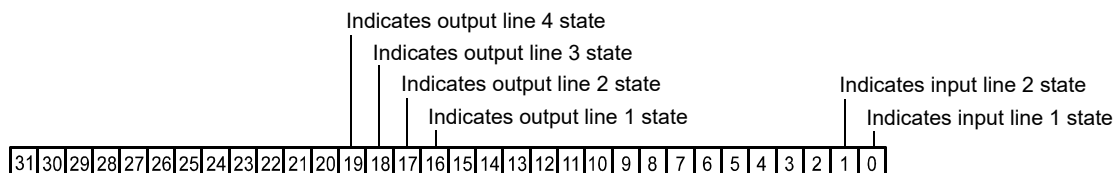

Fig. 20: Line Status All Parameter Bits

# 7 Image Acquisition Control

This chapter provides detailed information about controlling image acquisition. You will find information about triggering image acquisition, about setting the exposure time for acquired images, about controlling the camera's image acquisition rate, and about how the camera's maximum allowed image acquisition rate can vary depending on the current camera settings.



The sample code included in this chapter represents "low level" code that is actually used by the camera. Many tasks, however, can be programmed more conveniently with fewer lines of code when employing the Instant Camera classes, provided by the Basler pylon C++ API. For information about the Instant Camera classes, see the C++ *Programmer's Guide and Reference Documentation* delivered with the Basler pylon Camera Software Suite.

## 7.1 Overview

This section presents an overview of the elements involved with controlling the acquisition of images. Reading this section will give you an idea about how these elements fit together and will make it easier to understand the detailed information in the sections that follow.

Four major elements are involved in controlling the acquisition of images:

- Acquisition start and acquisition stop commands and the acquisition mode parameter
- The acquisition start trigger
- The frame start trigger
- Exposure time control

When reading the explanations in the overview and in this entire chapter, keep in mind that the term "frame" is typically used to mean a single acquired image.

When reading the material in this chapter, it is helpful to refer to Figure 21 on [page 57](#) and to the use case diagrams in Section 7.6 on [page 83](#). These diagrams present the material related to the acquisition start and stop commands, the acquisition mode, the acquisition start trigger, and the frame start trigger in a graphical format.

### Acquisition Start and Stop Commands and the Acquisition Mode

The Acquisition Start command prepares the camera to acquire frames. The camera cannot acquire frames unless an Acquisition Start command has first been executed.



A parameter called the Acquisition Mode has a direct bearing on how the Acquisition Start command operates.

If the Acquisition Mode parameter is set to "single frame", you can only acquire one frame after executing an Acquisition Start command. When one frame has been acquired, the Acquisition Start command will expire. Before attempting to acquire another frame, you must execute a new Acquisition Start command.

If the Acquisition Mode parameter is set to "continuous frame", an Acquisition Start command does not expire after a single frame is captured. Once an Acquisition Start command has been executed, you can acquire as many frames as you like. The Acquisition Start command will remain in effect until you execute an Acquisition Stop command. Once an Acquisition Stop command has been executed, the camera will not be able to acquire frames until a new Acquisition Start command is executed.

### **Acquisition Start Trigger**

The acquisition start trigger is characterized by the acquisition start trigger signals and the acquisition start trigger modes. It is essentially an enabler for the frame start trigger.

The acquisition start trigger has two modes of operation: off and on.

If the Trigger Mode parameter for the acquisition start trigger is set to off, the camera will generate all required acquisition start trigger signals internally, and you do not need to apply acquisition start trigger signals to the camera.

If the Trigger Mode parameter for the acquisition start trigger is set to on, the initial acquisition status of the camera will be "waiting for acquisition start trigger" (see Figure 21 on [page 57](#)). When the camera is in this acquisition status, it cannot react to frame start trigger signals. When an acquisition start trigger signal is applied to the camera, the camera will exit the "waiting for acquisition start trigger" acquisition status and enter a "waiting for frame start trigger" acquisition status. The camera can then react to frame start trigger signals. The camera will continue to react to frame start trigger signals until the number of frame start trigger signals it has received is equal to an integer parameter setting called the Acquisition Frame Count. At that point, the camera will return to the "waiting for acquisition start trigger" acquisition status and will remain in that status until a new acquisition start trigger signal is applied.

As an example, assume that the Trigger Mode parameter is set to on, the Acquisition Frame Count parameter is set to three, and the camera is in a "waiting for acquisition start trigger" acquisition status. When an acquisition start trigger signal is applied to the camera, it will exit the "waiting for acquisition start trigger" acquisition status and enter the "waiting for frame start trigger" acquisition status. Once the camera has received three frame start trigger signals, it will return to the "waiting for acquisition start trigger" acquisition status. At that point, you must apply a new acquisition start trigger signal to the camera to make it exit "waiting for acquisition start trigger".

### **Frame Start Trigger**

Assuming that an acquisition start trigger signal has just been applied to the camera, the camera will exit from the "waiting for acquisition start trigger" acquisition status and enter a "waiting for frame start trigger" acquisition status. Applying a frame start trigger signal to the camera at this point will exit the camera from the "waiting for frame start trigger" acquisition status and will begin the process of exposing and reading out a frame (see Figure 21 on [page 57](#)). As soon as the camera is ready to accept another frame start trigger signal, it will return to the "waiting for frame start

trigger" acquisition status. A new frame start trigger signal can then be applied to the camera to begin another frame exposure.

The frame start trigger has two modes: off and on.

If the Trigger Mode parameter for the frame start trigger is set to off, the camera will generate all required frame start trigger signals internally, and you do not need to apply frame start trigger signals to the camera. The rate at which the camera will generate the signals and acquire frames will be determined by the way that you set several frame rate related parameters.

If the Trigger Mode parameter for the frame start trigger is set to on, you must trigger frame start by applying frame start trigger signals to the camera. Each time a trigger signal is applied, the camera will begin a frame exposure. When frame start is being triggered in this manner, it is important that you do not attempt to trigger frames at a rate that is greater than the maximum allowed. (There is a detailed explanation about the maximum allowed frame rate at the end of this chapter.) Frame start trigger signals applied to the camera when it is not in a "waiting for frame start trigger" acquisition status will be ignored.

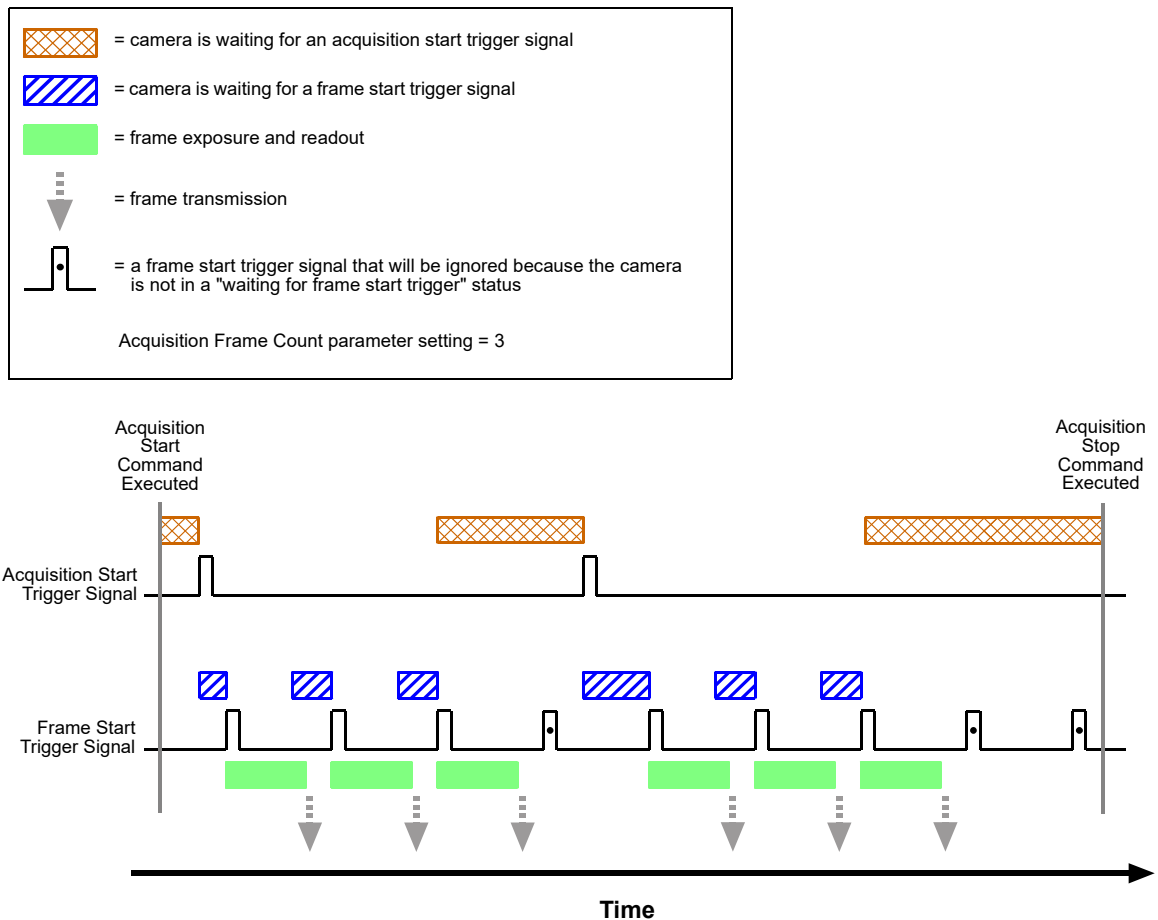

Fig. 21: Acquisition Start and Frame Start Triggering

## Applying Trigger Signals

The paragraphs above mention "applying a trigger signal". There are two ways to apply an acquisition start or a frame start trigger signal to the camera: via software or via hardware.

To apply trigger signals

- via **software**, you must first select the acquisition start or the frame start trigger and then indicate that software will be used as the source for the selected trigger signal. At that point, each time a Trigger Software command is executed, the selected trigger signal will be applied to the camera.



### Note

When applying trigger signals via software there is a delay that depends on the Camera Link interface. Note that, as a consequence, software trigger signals cannot be used to realize real-time capable triggers.

- via **hardware**, you must first select the acquisition start or the frame start trigger and then select an input line to be used as the source for the selected trigger signal. At that point, each time a proper electrical signal is applied to the input line, an occurrence of the selected trigger signal will be recognized by the camera.

## The Trigger Selector

The concept of the "trigger selector" is very important to understand when working with the acquisition start and frame start triggers. Many of the parameter settings and the commands that apply to the triggers have names that are not specific to a particular type of trigger, for example, the acquisition start trigger has a mode setting and the frame start trigger has a mode setting. But in Basler pylon there is a single parameter, the Trigger Mode parameter, that is used to set the mode for both of these triggers. Also, the Trigger Software command mentioned earlier can be executed for either the acquisition start trigger or the frame start trigger. So if you want to set the Trigger Mode or execute a Trigger Software command for the acquisition start trigger rather than the frame start trigger, how do you do it? The answer is, by using the Trigger Selector parameter. Whenever you want to work with a specific type of trigger, your first step is to set the Trigger Selector parameter to the trigger you want to work with (either the acquisition start trigger or the frame start trigger). At that point, the changes you make to the Trigger Mode, Trigger Source, etc., will be applied to the selected trigger only.

## Exposure Time Control

As mentioned earlier, when a frame start trigger signal is applied to the camera, the camera will begin to acquire a frame. A critical aspect of frame acquisition is how long the pixels in the camera's sensor will be exposed to light during the frame acquisition.

If the camera is set for software frame start triggering, a parameter called the Exposure Time Abs will determine the exposure time for each frame.

If the camera is set for hardware frame start triggering, there are two modes of operation:

- "timed" mode:  
With the "timed mode", the Exposure Time Abs parameter will determine the exposure time for each frame.
- and "trigger width":  
With the "trigger width" mode, the way that you manipulate the rise and fall of the hardware signal will determine the exposure time.

The "trigger width" mode is especially useful,

- if you want to change the exposure time from frame to frame, and
- if you require exposure times that are longer than the maximum possible exposure time you can set via the exposure time parameter.

You can use the sequencer feature as an alternative to the "trigger width" mode if you require exposure times that are periodically changing from frame to frame. For information on the sequencer feature, see Section 10.10 on [page 185](#).

## 7.2 Acquisition Start and Stop Commands and the Acquisition Mode

Executing an Acquisition Start command prepares the camera to acquire frames. You must execute an Acquisition Start command before you can begin acquiring frames.

Executing an Acquisition Stop command terminates the camera's ability to acquire frames. When the camera receives an Acquisition stop command:

- If the camera is not in the process of acquiring a frame, its ability to acquire frames will be terminated immediately.
- If the camera is in the process of acquiring a frame, the frame acquisition process will be allowed to finish and the camera's ability to acquire new frames will be terminated.

The camera's Acquisition Mode parameter has two settings: single frame and continuous. The use of Acquisition Start and Acquisition Stop commands and the camera's Acquisition Mode parameter setting are related.

If the camera's Acquisition Mode parameter is set for single frame, after an Acquisition Start command has been executed, a single frame can be acquired. When acquisition of one frame is complete, the camera will execute an Acquisition Stop command internally and will no longer be able to acquire frames. To acquire another frame, you must execute a new Acquisition Start command.

If the camera's Acquisition Mode parameter is set for continuous frame, after an Acquisition Start command has been executed, frame acquisition can be triggered as desired. Each time a frame trigger is applied while the camera is in a "waiting for frame trigger" acquisition status, the camera will acquire and transmit a frame. The camera will retain the ability to acquire frames until an Acquisition Stop command is executed. Once the Acquisition Stop command is received, the camera will no longer be able to acquire frames.



When the camera's acquisition mode is set to single frame, the maximum possible acquisition frame rate for a given AOI cannot be achieved. This is true because the camera performs a complete internal setup cycle for each single frame and because it cannot be operated with "overlapped" exposure.

To achieve the maximum possible acquisition frame rate, set the camera for the continuous acquisition mode and use "overlapped" exposure.

For more information about overlapped exposure, see Section 7.6 on [page 83](#).

## Setting the Acquisition Mode and Issuing Start/Stop Commands

You can set the Acquisition Mode parameter value and you can execute Acquisition Start or Acquisition Stop commands from within your application software by using the Basler pylon API. The code snippet below illustrates using the API to set the Acquisition Mode parameter value and to execute an Acquisition Start command. Note that the snippet also illustrates setting several parameters regarding frame triggering. These parameters are discussed later in this chapter.

```
Camera.AcquisitionMode.SetValue( AcquisitionMode_SingleFrame );
Camera.TriggerSelector.SetValue( TriggerSelector_FrameStart );
Camera.TriggerMode.SetValue( TriggerMode_On );
Camera.TriggerSource.SetValue ( TriggerSource_Line1 );
Camera.TriggerActivation.SetValue( TriggerActivation_RisingEdge );
Camera.ExposureMode.SetValue( ExposureMode_Timed );
Camera.ExposureTimeAbs.SetValue( 3000 );
Camera.AcquisitionStart.Execute( );
```

You can also use the Basler pylon Viewer application to easily set the parameters.

For more information about the pylon API and the pylon Viewer, see Section 3 on [page 21](#).

## 7.3 The Acquisition Start Trigger

When reading this section, it is helpful to refer to Figure 21 on [page 57](#).

The acquisition start trigger is used in conjunction with the frame start trigger to control the acquisition of frames. In essence, the acquisition start trigger is used as an enabler for the frame start trigger. Acquisition start trigger signals can be generated within the camera or may be applied externally as software or hardware acquisition start trigger signals.

When the acquisition start trigger is enabled, the camera's initial acquisition status is "waiting for acquisition start trigger". When the camera is in this acquisition status, it will ignore any frame start trigger signals it receives. If an acquisition start trigger signal is applied to the camera, it will exit the "waiting for acquisition start trigger" acquisition status and enter the "waiting for frame start trigger" acquisition status. In this acquisition status, the camera can react to frame start trigger signals and will begin to expose a frame each time a proper frame start trigger signal is applied.

A primary feature of the acquisition start trigger is that after an acquisition start trigger signal has been applied to the camera and the camera has entered the "waiting for frame start trigger" acquisition status, the camera will return to the "waiting for acquisition start trigger" acquisition status once a specified number of frame start triggers has been received. Before more frames can be acquired, a new acquisition start trigger signal must be applied to the camera to exit it from "waiting for acquisition start trigger" status. Note that this feature only applies when the Trigger Mode parameter for the acquisition start trigger is set to on. This feature is explained in greater detail in the following sections.

### 7.3.1 Acquisition Start Trigger Mode

The main parameter associated with the acquisition start trigger is the Trigger Mode parameter. The Trigger Mode parameter for the acquisition start trigger has two available settings: off and on.

#### 7.3.1.1 Acquisition Start Trigger Mode = Off

When the Trigger Mode parameter for the acquisition start trigger is set to off, the camera will generate all required acquisition start trigger signals internally, and you do not need to apply acquisition start trigger signals to the camera.

#### 7.3.1.2 Acquisition Start Trigger Mode = On

When the Trigger Mode parameter for the acquisition start trigger is set to on, the camera will initially be in a "waiting for acquisition start trigger" acquisition status and cannot react to frame start trigger signals. You must apply an acquisition start trigger signal to the camera to exit the camera from the "waiting for acquisition start trigger" acquisition status and enter the "waiting for frame start trigger" acquisition status. The camera can then react to frame start trigger signals and will continue to do so until the number of frame start trigger signals it has received is equal to the current Acquisition

Frame Count parameter setting. The camera will then return to the "waiting for acquisition start trigger" acquisition status. In order to acquire more frames, you must apply a new acquisition start trigger signal to the camera to exit it from the "waiting for acquisition start trigger" acquisition status.

When the Trigger Mode parameter for the acquisition start trigger is set to on, you must select a source signal to serve as the acquisition start trigger. The Trigger Source parameter specifies the source signal. The available selections for the Trigger Source parameter are:

- Software - When the source signal is set to software, you apply an acquisition start trigger signal to the camera by executing an Trigger Software command for the acquisition start trigger on the host PC.
- Line 1 - When the source signal is set to line 1, you apply an acquisition start trigger signal to the camera by injecting an externally generated electrical signal (commonly referred to as a hardware trigger signal) into physical input line 1 on the camera.
- Line 2 - When the source signal is set to line 2, you apply an acquisition start trigger signal to the camera by injecting an externally generated electrical signal (commonly referred to as a hardware trigger signal) into physical input line 2 on the camera.

If the Trigger Source parameter for the acquisition start trigger is set to Line 1 or Line 2, you must also set the Trigger Activation parameter. The available settings for the Trigger Activation parameter are:

- Rising Edge - specifies that a rising edge of the electrical signal will act as the acquisition start trigger.
- Falling Edge - specifies that a falling edge of the electrical signal will act as the acquisition start trigger.



When the Trigger Mode parameter for the acquisition start trigger is set to on, the camera's Acquisition Mode parameter should be set to continuous. If the Acquisition Mode parameter is set to single frame, only a single frame is acquired regardless of the Acquisition Frame Count parameter setting.

For more information about the Acquisition Mode parameter, see Section 7.2 on [page 60](#).



## 7.3.2 Acquisition Frame Count

When the Trigger Mode parameter for the acquisition start trigger is set to on, you must set the value of the camera's Acquisition Frame Count parameter. The value of the Acquisition Frame Count can range from 1 to 255.

With acquisition start triggering on, the camera will initially be in a "waiting for acquisition start trigger" acquisition status. When in this acquisition status, the camera cannot react to frame start trigger signals. If an acquisition start trigger signal is applied to the camera, the camera will exit the "waiting for acquisition start trigger" acquisition status and will enter the "waiting for frame start trigger" acquisition status. It can then react to frame start trigger signals. When the camera has received a number of frame start trigger signals equal to the current Acquisition Frame Count parameter setting, it will return to the "waiting for acquisition start trigger" acquisition status. At that point, you must apply a new acquisition start trigger signal to exit the camera from the "waiting for acquisition start trigger" acquisition status.

### 7.3.3 Setting The Acquisition Start Trigger Mode and Related Parameters

You can set the Trigger Mode and Trigger Source parameters for the acquisition start trigger and also set the Acquisition Frame Count parameter value from within your application software by using the Basler pylon API.

The following code snippet illustrates using the API to set the Trigger Mode to on, the Trigger Source to software, and the Acquisition Frame Count to 5:

```
// Set the acquisition mode to continuous (the acquisition mode must
// be set to continuous when acquisition start triggering is on)
Camera.AcquisitionMode.SetValue( AcquisitionMode_Continuous );

// Select the acquisition start trigger
Camera.TriggerSelector.SetValue( TriggerSelector_AcquisitionStart );
// Set the mode for the selected trigger
Camera.TriggerMode.SetValue( TriggerMode_On );
// Set the source for the selected trigger
Camera.TriggerSource.SetValue ( TriggerSource_Software );
// Set the acquisition frame count
Camera.AcquisitionFrameCount.SetValue( 5 );
```

The following code snippet illustrates using the API to set the Trigger Mode to on, the Trigger Source to line 1, the Trigger Activation to rising edge, and the Acquisition Frame Count to 5:

```
// Set the acquisition mode to continuous (the acquisition mode must
// be set to continuous when acquisition start triggering is on)
Camera.AcquisitionMode.SetValue( AcquisitionMode_Continuous );

// Select the acquisition start trigger
Camera.TriggerSelector.SetValue( TriggerSelector_AcquisitionStart );
// Set the mode for the selected trigger
Camera.TriggerMode.SetValue( TriggerMode_On );
// Set the source for the selected trigger
Camera.TriggerSource.SetValue ( TriggerSource_Line1 );
// Set the activation mode for the selected trigger to rising edge
Camera.TriggerActivation.SetValue( TriggerActivation_RisingEdge );
// Set the acquisition frame count
Camera.AcquisitionFrameCount.SetValue( 5 );
```

You can also use the Basler pylon Viewer application to easily set the parameters.

For more information about the pylon API and the pylon Viewer, see Section 3 on [page 21](#).

## 7.3.4 Using a Software Acquisition Start Trigger Signal

### 7.3.4.1 Introduction

If the camera's Acquisition Start Trigger Mode parameter is set to on and the Acquisition Start Trigger Source parameter is set to software, you must apply a software acquisition start trigger signal to the camera before you can begin frame acquisition.

A software acquisition start trigger signal is applied by:

- Setting the Trigger Selector parameter to Acquisition Start.
- Executing a Trigger Software command.

The camera will initially be in a "waiting for acquisition start trigger" acquisition status. It cannot react to frame trigger signals when in this acquisition status. When a software acquisition start trigger signal is received by the camera, it will exit the "waiting for acquisition start trigger" acquisition status and will enter the "waiting for frame start trigger" acquisition status. It can then react to frame start trigger signals. When the number of frame start trigger signals received by the camera is equal to the current Acquisition Frame Count parameter setting, the camera will return to the "waiting for acquisition start trigger" acquisition status. When a new software acquisition start trigger signal is applied to the camera, it will again exit from the "waiting for acquisition start trigger" acquisition status and enter the "waiting for frame start trigger" acquisition status.

(Note that as long as the Trigger Selector parameter is set to Acquisition Start, a software acquisition start trigger will be applied to the camera each time a Trigger Software command is executed.)

### 7.3.4.2 Setting the Parameters Related to Software Acquisition Start Triggering and Applying a Software Trigger Signal

You can set all of the parameters needed to perform software acquisition start triggering from within your application software by using the Basler pylon API. The following code snippet illustrates using the API to set the parameter values and to execute the commands related to software acquisition start triggering with the camera set for continuous frame acquisition mode:

```
// Set the acquisition mode to continuous (the acquisition mode must
// be set to continuous when acquisition start triggering is on)
Camera.AcquisitionMode.SetValue( AcquisitionMode_Continuous );

// Select the acquisition start trigger
Camera.TriggerSelector.SetValue( TriggerSelector_AcquisitionStart );
// Set the mode for the selected trigger
Camera.TriggerMode.SetValue( TriggerMode_On );
// Set the source for the selected trigger
Camera.TriggerSource.SetValue ( TriggerSource_Software );
// Set the acquisition frame count
Camera.AcquisitionFrameCount.SetValue( 5 );
```

```
// Execute an acquisition start command to prepare for frame acquisition
Camera.AcquisitionStart.Execute( );
while ( ! finished )
{
    // Execute a trigger software command to apply a software acquisition
    // start trigger signal to the camera
    Camera.TriggerSoftware.Execute( );

    // Perform the required functions to parameterize the frame start
    // trigger, to trigger 5 frame starts, and to retrieve 5 frames here
}
Camera.AcquisitionStop.Execute( );

// Note: as long as the Trigger Selector is set to Acquisition Start, executing
// a Trigger Software command will apply a software acquisition start trigger
// signal to the camera
```

You can also use the Basler pylon Viewer application to easily set the parameters.

For more information about the pylon API and the pylon Viewer, see Section 3 on [page 21](#).

## 7.3.5 Using a Hardware Acquisition Start Trigger Signal

### 7.3.5.1 Introduction

If the Trigger Mode parameter for the acquisition start trigger is set to on and the Trigger Source parameter is set to input line 1 or line 2, an externally generated electrical signal injected into the selected source will act as the acquisition start trigger signal for the camera. This type of trigger signal is generally referred to as a hardware trigger signal or as an external acquisition start trigger signal (ExASTrig).

A rising edge or a falling edge of the ExASTrig signal can be used to trigger acquisition start. The Trigger Activation parameter is used to select rising edge or falling edge triggering.

When the Trigger Mode parameter is set to on, the camera will initially be in a "waiting for acquisition start trigger" acquisition status. It cannot react to frame start trigger signals when in this acquisition status. When the appropriate ExASTrig signal is applied to the selected source (e.g, a rising edge of the signal for rising edge triggering), the camera will exit the "waiting for acquisition start trigger" acquisition status and will enter the "waiting for frame start trigger" acquisition status. It can then react to frame start trigger signals. When the number of frame start trigger signals received by the camera is equal to the current Acquisition Frame Count parameter setting, the camera will return to the "waiting for acquisition start trigger" acquisition status. When a new ExASTrig signal is applied to the selected source, the camera will again exit from the "waiting for acquisition start trigger" acquisition status and enter the "waiting for frame start trigger" acquisition status.

For more information about setting the camera for hardware acquisition start triggering and selecting the input line to receive the ExASTrig signal, see Section 7.3.5.3.

For more information about the electrical requirements for input line 1 and line 2, see Section 5.6 on [page 35](#).

### 7.3.5.2 Acquisition Start Trigger Delay

The acquisition start trigger delay feature lets you specify a delay (in microseconds) that will be applied between the receipt of a hardware acquisition start trigger and when the trigger will become effective.

The acquisition start trigger delay may be specified in the range from 0 to 10000000  $\mu$ s (equivalent to 1 s). When the delay is set to 0  $\mu$ s, no delay will be applied.

To set the acquisition start trigger delay:

- Set the camera's Trigger Selector parameter to Acquisition Start.
- Set the value of the Trigger Delay Abs parameter.



The acquisition start trigger delay will not operate if the acquisition start trigger mode is set to off or if you are using a software acquisition start trigger.

### 7.3.5.3 Setting the Parameters Related to Hardware Acquisition Start Triggering and Applying a Hardware Trigger Signal

You can set all of the parameters needed to perform hardware acquisition start triggering from within your application by using the Basler pylon API. The following code snippet illustrates using the API to set the parameter values required to enable rising edge hardware acquisition start triggering with line 1 as the trigger source:

```
// Set the acquisition mode to continuous (the acquisition mode must
// be set to continuous when acquisition start triggering is on)
Camera.AcquisitionMode.SetValue( AcquisitionMode_Continuous );

// Select the acquisition start trigger
Camera.TriggerSelector.SetValue( TriggerSelector_AcquisitionStart );
// Set the mode for the selected trigger
Camera.TriggerMode.SetValue( TriggerMode_On );
// Set the source for the selected trigger
Camera.TriggerSource.SetValue ( TriggerSource_Line1 );
// Set the activation mode for the selected trigger to rising edge
Camera.TriggerActivation.SetValue( TriggerActivation_RisingEdge );
// Set the acquisition frame count
Camera.AcquisitionFrameCount.SetValue( 5 );
// Execute an acquisition start command to prepare for frame acquisition
Camera.AcquisitionStart.Execute( );
    while ( ! finished )
    {
```

```
// Apply a rising edge of the externally generated electrical signal
// (ExASTrig signal) to input line 1 on the camera

        // Perform the required functions to parameterize the frame start
        // trigger, to trigger 5 frame starts, and to retrieve 5 frames here
    }
    Camera.AcquisitionStop.Execute( );
```

You can also use the Basler pylon Viewer application to easily set the parameters.

For more information about the pylon API and the pylon Viewer, see Section 3 on [page 21](#).

## 7.4 The Frame Start Trigger

The frame start trigger is used to begin frame acquisition. Assuming that the camera is in a "waiting for frame start trigger" acquisition status, it will begin a frame acquisition each time it receives a frame start trigger signal.

Note that in order for the camera to be in a "waiting for frame start trigger" acquisition status:

- The Acquisition Mode parameter must be set correctly.
- A proper Acquisition Start command must be applied to the camera.
- A proper acquisition start trigger signal must be applied to the camera (if the Trigger Mode parameter for the acquisition start trigger is set to on).

For more information about the Acquisition Mode parameter and about Acquisition Start and Acquisition Stop commands, see Section 7.1 on [page 55](#) and Section 7.2 on [page 60](#).

For more information about the acquisition start trigger, and about the acquisition status, see Section 7.1 on [page 55](#) and Section 7.3 on [page 62](#).

Referring to the use case diagrams that appear in Section 7.6 on [page 83](#) can help you understand the explanations of the frame start trigger.



## 7.4.1 Frame Start Trigger Mode

The main parameter associated with the frame start trigger is the Trigger Mode parameter. The Trigger Mode parameter for the frame start trigger has two available settings: off and on.

### 7.4.1.1 Frame Start Trigger Mode = Off

When the Frame Start Trigger Mode parameter is set to off, the camera will generate all required frame start trigger signals internally, and you do not need to apply frame start trigger signals to the camera.

With the trigger mode set to off, the way that the camera will operate the frame start trigger depends on the setting of the camera's Acquisition Mode parameter:

If the Acquisition Mode parameter is set

- to **single frame**, the camera will automatically generate a single frame start trigger signal whenever it receives an Acquisition Start command.
- to **continuous frame**, the camera will automatically begin generating frame start trigger signals when it receives an Acquisition Start command. The camera will continue to generate frame start trigger signals until it receives an Acquisition Stop command.

The rate at which the frame start trigger signals are generated may be determined by the camera's Acquisition Frame Rate Abs parameter:

- If the parameter is **not enabled**, the camera will generate frame start trigger signals at the maximum rate allowed with the current camera settings.
- If the parameter is **enabled** and is set to a value less than the maximum allowed frame rate with the current camera settings, the camera will generate frame start trigger signals at the rate specified by the parameter setting.
  - If the parameter is enabled and is set to a value greater than the maximum allowed frame rate with the current camera settings, the camera will generate frame start trigger signals at the maximum allowed frame rate.



The camera will only react to frame start triggers when it is in a "waiting for frame start trigger" acquisition status. For more information about the acquisition status, see Section 7.1 on [page 55](#) and Section 7.3 on [page 62](#).

### Exposure Time Control with the Frame Start Trigger Mode Off

When the Trigger Mode parameter for the frame start trigger is set to off, the exposure time for each frame acquisition is determined by the value of the camera's Exposure Time Abs parameter.

For more information about the camera's Exposure Time Abs parameter, see Section 7.5 on [page 82](#).

### 7.4.1.2 Frame Start Trigger Mode = On

When the Trigger Mode parameter for the frame start trigger is set to on, you must apply a frame start trigger signal to the camera each time you want to begin a frame acquisition. The Trigger Source parameter specifies the source signal that will act as the frame start trigger signal. The available selections for the Trigger Source parameter are:

- Software - When the source signal is set to software, you apply a frame start trigger signal to the camera by executing a Trigger Software command for the frame start trigger on the host PC.
- Line 1 - When the source signal is set to line 1, you apply a frame start trigger signal to the camera by injecting an externally generated electrical signal (commonly referred to as a hardware trigger signal) into physical input line 1 on the camera.
- Line 2 - When the source signal is set to line 2, you apply a frame start trigger signal to the camera by injecting an externally generated electrical signal (commonly referred to as a hardware trigger signal) into physical input line 1 on the camera.

If the Trigger Source parameter is set to line 1 or line 2, you must also set the Trigger Activation parameter. The available settings for the Trigger Activation parameter are:

- Rising Edge - specifies that a rising edge of the electrical signal will act as the frame start trigger.
- Falling Edge - specifies that a falling edge of the electrical signal will act as the frame start trigger.

For more information about

- using a software trigger to control frame acquisition start, see Section 7.4.2 on [page 75](#).
- using a hardware trigger to control frame acquisition start, see Section 7.4.3 on [page 77](#).



By default, input line 1 is selected as the source signal for the frame start trigger and input line 2 is selected as the source signal for the acquisition start trigger. Keep in mind that the camera will only react to frame start trigger signals when it is in a "waiting for frame start trigger" acquisition status. For more information about the acquisition status, see Section 7.1 on [page 55](#) and Section 7.3 on [page 62](#).

### Exposure Time Control with the Frame Start Trigger Mode On

When the Trigger Mode parameter for the frame start trigger is set to on and the Trigger Source parameter is set to software, the exposure time for each frame acquisition is determined by the value of the camera's Exposure Time Abs parameter.

When the Trigger Mode parameter is set to on and the Trigger Source parameter is set to one of the input lines, the exposure time for each frame acquisition can be controlled with the Exposure Time Abs parameter or it can be controlled by manipulating the hardware trigger signal.

For more information about

- controlling exposure time when using a software trigger, see Section 7.4.2 on [page 75](#)
- controlling exposure time when using a hardware trigger, see Section 7.4.3 on [page 77](#).

### 7.4.1.3 Setting The Frame Start Trigger Mode and Related Parameters

You can set the Trigger Mode and related parameter values for the frame start trigger from within your application software by using the Basler pylon API. If your settings make it necessary, you can also set the Trigger Source parameter.

The following code snippet illustrates using the API to set the Trigger Mode for the frame start trigger to on and the Trigger Source to input line 1:

```
// Select the frame start trigger
Camera.TriggerSelector.SetValue( TriggerSelector_FrameStart );
// Set the mode for the selected trigger
Camera.TriggerMode.SetValue( TriggerMode_On );
// Set the source for the selected trigger
Camera.TriggerSource.SetValue ( TriggerSource_Line1 );
```

The following code snippet illustrates using the API to set the Acquisition Mode to continuous, the Trigger Mode to off, and the Acquisition Frame Rate to 60:

```
// Set the acquisition mode to continuous frame
Camera.AcquisitionMode.SetValue( AcquisitionMode_Continuous );
// Select the frame start trigger
Camera.TriggerSelector.SetValue( TriggerSelector_FrameStart );
// Set the mode for the selected trigger
Camera.TriggerMode.SetValue( TriggerMode_Off );
// Set the exposure time
Camera.ExposureTimeAbs.SetValue( 3000 );
// Enable the acquisition frame rate parameter and set the frame rate. (Enabling
// the acquisition frame rate parameter allows the camera to control the frame
// rate internally.)
Camera.AcquisitionFrameRateEnable.SetValue( true );
Camera.AcquisitionFrameRateAbs.SetValue( 60.0 );
// Start frame capture
Camera.AcquisitionStart.Execute( );
```

You can also use the Basler pylon Viewer application to easily set the parameters.

For more information about the pylon API and the pylon Viewer, see Section 3 on [page 21](#).

## 7.4.2 Using a Software Frame Start Trigger Signal

### 7.4.2.1 Introduction

If the Trigger Mode parameter for the frame start trigger is set to on and the Trigger Source parameter is set to software, you must apply a software frame start trigger signal to the camera to begin each frame acquisition. Assuming that the camera is in a "waiting for frame start trigger" acquisition status, frame exposure will start when the software frame start trigger signal is received by the camera. Figure 22 illustrates frame acquisition with a software frame start trigger signal.

When the camera receives a software trigger signal and begins exposure, it will exit the "waiting for frame start trigger" acquisition status because at that point, it cannot react to a new frame start trigger signal. As soon as the camera is capable of reacting to a new frame start trigger signal, it will automatically return to the "waiting for frame start trigger" acquisition status.

When you are using a software trigger signal to start each frame acquisition, the camera's Exposure Mode parameter must be set to timed. The exposure time for each acquired frame will be determined by the value of the camera's Exposure Time Abs parameter.

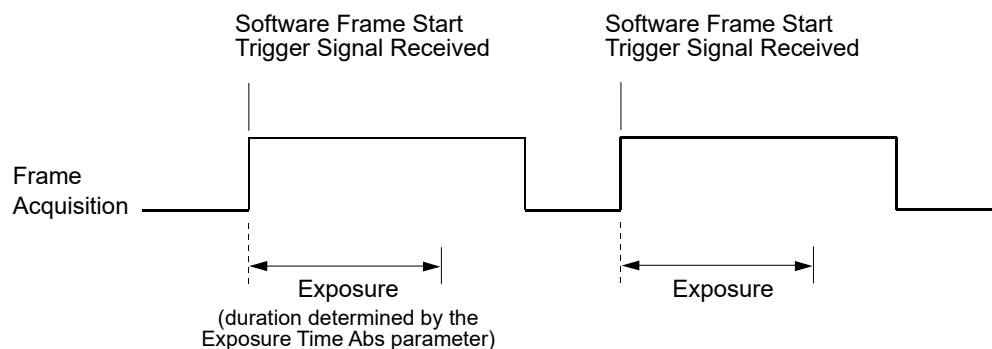

Fig. 22: Frame Acquisition with a Software Frame Start Trigger

When you are using a software trigger signal to start each frame acquisition, the frame rate will be determined by how often you apply a software trigger signal to the camera, and you should not attempt to trigger frame acquisition at a rate that exceeds the maximum allowed for the current camera settings. (There is a detailed explanation about the maximum allowed frame rate at the end of this chapter.) Software frame start trigger signals that are applied to the camera when it is not ready to receive them will be ignored.

Section 7.4.2.2 on [page 76](#) includes more detailed information about applying a software frame start trigger signal to the camera using Basler pylon.

For more information about determining the maximum allowed frame rate, see Section 7.9 on [page 93](#).

## 7.4.2.2 Setting the Parameters Related to Software Frame Start Triggering and Applying a Software Trigger Signal

You can set all of the parameters needed to perform software frame start triggering from within your application software by using the Basler pylon API. The following code snippet illustrates using the API to set the parameter values and to execute the commands related to software frame start triggering with the camera set for continuous frame acquisition mode. In this example, the trigger mode for the acquisition start trigger will be set to off:

```
// Set the acquisition mode to continuous frame
Camera.AcquisitionMode.SetValue( AcquisitionMode_Continuous );
// Select the acquisition start trigger
Camera.TriggerSelector.SetValue( TriggerSelector_AcquisitionStart );
// Set the mode for the selected trigger
Camera.TriggerMode.SetValue( TriggerMode_Off );
// Disable the acquisition frame rate parameter (this will disable the camera's
// internal frame rate control and allow you to control the frame rate with
// software frame start trigger signals within the limits imposed by other
// parameter settings).
Camera.AcquisitionFrameRateEnable.SetValue( false );
// Select the frame start trigger
Camera.TriggerSelector.SetValue( TriggerSelector_FrameStart );
// Set the mode for the selected trigger
Camera.TriggerMode.SetValue( TriggerMode_On );
// Set the source for the selected trigger
Camera.TriggerSource.SetValue ( TriggerSource_Software );
// Set for the timed exposure mode
Camera.ExposureMode.SetValue( ExposureMode_Timed );
// Set the exposure time
Camera.ExposureTimeAbs.SetValue( 3000 );
// Execute an acquisition start command to prepare for frame acquisition
Camera.AcquisitionStart.Execute( );
while ( ! finished )
{
    // Execute a Trigger Software command to apply a frame start
    // trigger signal to the camera
    Camera.TriggerSoftware.Execute( );
    // Retrieve acquired frame here
}
    Camera.AcquisitionStop.Execute( );

// Note: as long as the Trigger Selector is set to FrameStart, executing
// a Trigger Software command will apply a software frame start trigger
// signal to the camera
```

You can also use the Basler pylon Viewer application to easily set the parameters.

For more information about the pylon API and the pylon Viewer, see Section 3 on [page 21](#).

## 7.4.3 Using a Hardware Frame Start Trigger Signal

### 7.4.3.1 Introduction

If the Trigger Mode parameter for the frame start trigger is set to on and the Trigger Source parameter is set to input line 1 or line 2, an externally generated electrical signal injected into the selected source will act as the frame start trigger signal for the camera. This type of trigger signal is generally referred to as a hardware trigger signal or as an external frame start trigger signal (ExFSTrig).

A rising edge or a falling edge of the ExFSTrig signal can be used to trigger frame acquisition. The Trigger Activation parameter is used to select rising edge or falling edge triggering.

Assuming that the camera is in a "waiting for frame start trigger" acquisition status, frame acquisition will start whenever the appropriate edge transition is received by the camera.

When the camera receives a hardware trigger signal and begins exposure, it will exit the "waiting for frame start trigger" acquisition status because at that point, it cannot react to a new frame start trigger signal. As soon as the camera is capable of reacting to a new frame start trigger signal, it will automatically return to the "waiting for frame start trigger" acquisition status.

When the camera is operating under control of an ExFSTrig signal, the period of the ExFSTrig signal will determine the rate at which the camera is acquiring frames:

$$\frac{1}{\text{ExFSTrig period in seconds}} = \text{Frame Rate}$$

For example, if you are operating a camera with an ExFSTrig signal period of 20 ms (0.020 s):

$$\frac{1}{0.020} = 50 \text{ fps}$$

So in this case, the frame rate is 50 fps.



If you are triggering frame acquisition with an ExFSTrig signal and you attempt to acquire frames at too high a rate, some of the frame trigger signals that you apply will be received by the camera when it is not in a "waiting for frame start trigger" acquisition status. The camera will ignore any frame start trigger signals that it receives when it is not "waiting for frame start trigger". (This situation is commonly referred to as "over triggering" the camera.)

To avoid over triggering, you should not attempt to acquire frames at a rate that exceeds the maximum allowed with the current camera settings.

For more information about

- setting the camera for hardware frame start triggering and selecting an input line to receive the ExFSTrig signal, see Section 7.4.3.4 on [page 80](#).
- the electrical requirements for the input lines, see Section 5.6 on [page 35](#).
- over triggering, see Section 7.7.3.2 on [page 89](#).
- determining the maximum allowed frame rate, see Section 7.9 on [page 93](#).

### 7.4.3.2 Exposure Modes

If you are triggering the start of frame acquisition with an externally generated frame start trigger (ExFSTrig) signal, two exposure modes are available: timed and trigger width.

#### Timed Exposure Mode

When timed mode is selected, the exposure time for each frame acquisition is determined by the value of the camera's Exposure Time Abs parameter. If the camera is set for rising edge triggering, the exposure time starts when the ExFSTrig signal rises. If the camera is set for falling edge triggering, the exposure time starts when the ExFSTrig signal falls. Figure 23 illustrates timed exposure with the camera set for rising edge triggering.

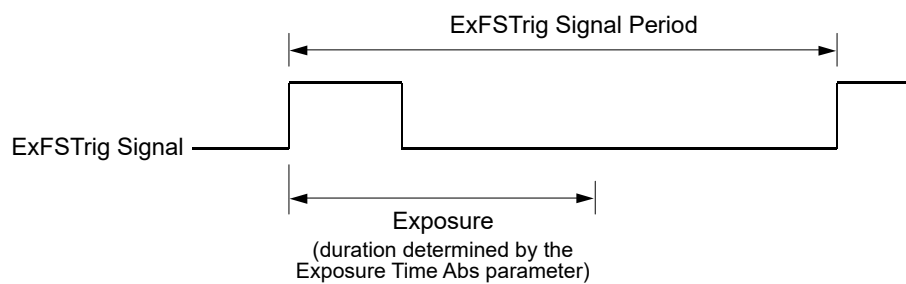

Fig. 23: Timed Exposure with Rising Edge Triggering

Note that if you attempt to trigger a new exposure start while the previous exposure is still in progress, the trigger signal will be ignored, and a Frame Start Overtrigger event will be generated. This situation is illustrated in Figure 24 for rising edge triggering.

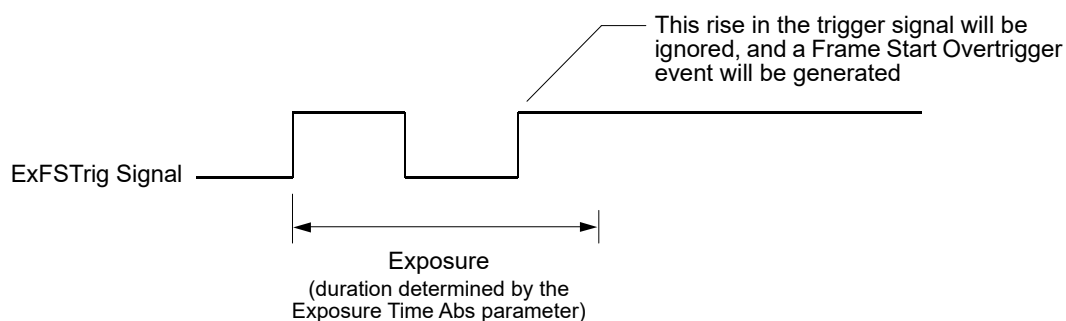

Fig. 24: Overtriggering with Timed Exposure

For more information about

- the Frame Start Overtrigger event, see Section 10.14 on [page 235](#).
- the camera's Exposure Time Abs parameter, see Section 7.5 on [page 82](#).

## Trigger Width Exposure Mode

When trigger width exposure mode is selected, the length of the exposure for each frame acquisition will be directly controlled by the ExFSTrig signal. If the camera is set for rising edge triggering, the exposure time begins when the ExFSTrig signal rises and continues until the ExFSTrig signal falls. If the camera is set for falling edge triggering, the exposure time begins when the ExFSTrig signal falls and continues until the ExFSTrig signal rises. Figure 25 illustrates trigger width exposure with the camera set for rising edge triggering.

Trigger width exposure is especially useful if you intend to vary the length of the exposure time for each captured frame.

If you want to set exposure times that are longer than the maximum possible exposure time settings you can use the trigger width mode.

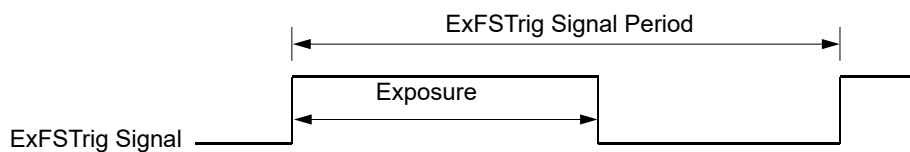

Fig. 25: Trigger Width Exposure with Rising Edge Triggering

When you operate the camera in trigger width exposure mode, you must also set the camera's Exposure Overlap Time Max Abs parameter. This parameter setting will be used by the camera to operate the Frame Trigger Wait signal.

You should set the Exposure Overlap Time Max Abs parameter value to represent the shortest exposure time you intend to use. For example, assume that you will be using trigger width exposure mode and that you intend to use the ExFSTrig signal to vary the exposure time in a range from 3000  $\mu$ s to 5500  $\mu$ s. In this case you would set the camera's Exposure Overlap Time Max Abs parameter to 3000  $\mu$ s.



### 7.4.3.3 Frame Start Trigger Delay

The frame start trigger delay feature lets you specify a delay (in microseconds) that will be applied between the receipt of a hardware frame start trigger and when the trigger will become effective.

The frame start trigger delay can be specified in the range from 0 to 1000000  $\mu\text{s}$  (equivalent to 1 s). When the delay is set to 0  $\mu\text{s}$ , no delay will be applied.

To set the frame start trigger delay:

- Set the camera's Trigger Selector parameter to frame start.
- Set the value of the Trigger Delay Abs parameter.



The frame start trigger delay will not operate if the Frame Start Trigger Mode parameter is set to off or if you are using a software frame start trigger.

### 7.4.3.4 Setting the Parameters Related to Hardware Frame Start Triggering and Applying a Hardware Trigger Signal

You can set all of the parameters needed to perform hardware frame start triggering from within your application by using the Basler pylon API. The following code snippet illustrates using the API to set the camera for single frame acquisition mode with the trigger mode for the acquisition start trigger set to off. We will use the timed exposure mode with input line 1 as the trigger source and with rising edge triggering. In this example, we will use a trigger delay:

```
// Set the acquisition mode to single frame
Camera.AcquisitionMode.SetValue( AcquisitionMode_SingleFrame );
// Select the acquisition start trigger
Camera.TriggerSelector.SetValue( TriggerSelector_AcquisitionStart );
// Set the mode for the selected trigger
Camera.TriggerMode.SetValue( TriggerMode_Off );
// Select the frame start trigger
Camera.TriggerSelector.SetValue( TriggerSelector_FrameStart );
// Set the mode for the selected trigger
Camera.TriggerMode.SetValue( TriggerMode_On );
// Set the source for the selected trigger
Camera.TriggerSource.SetValue ( TriggerSource_Line1 );
// Set the trigger activation mode to rising edge
Camera.TriggerActivation.SetValue( TriggerActivation_RisingEdge );
// Set the trigger delay for one millisecond (1000us == 1ms == 0.001s)
double TriggerDelay_us = 1000.0;
Camera.TriggerDelayAbs.SetValue( TriggerDelay_us );
// Set for the timed exposure mode
Camera.ExposureMode.SetValue( ExposureMode_Timed );
```

```

// Set the exposure time
Camera.ExposureTimeAbs.SetValue( 3000 );
// Execute an acquisition start command to prepare for frame acquisition
Camera.AcquisitionStart.Execute( );

// Frame acquisition will start when the externally generated
// frame start trigger signal (ExFSTrig signal) goes high

```

The following code snippet illustrates using the API to set the parameter values and execute the commands related to hardware frame start triggering with the camera set for continuous frame acquisition mode and the trigger mode for the acquisition start trigger set to off. We will use the trigger width exposure mode with input line 1 as the trigger source and with rising edge triggering:

```

// Set the acquisition mode to continuous frame
Camera.AcquisitionMode.SetValue( AcquisitionMode_Continuous );
// Select the acquisition start trigger
Camera.TriggerSelector.SetValue( TriggerSelector_AcquisitionStart );
// Set the mode for the selected trigger
Camera.TriggerMode.SetValue( TriggerMode_Off );
// Disable the acquisition frame rate parameter (this will disable the camera's
// internal frame rate control and allow you to control the frame rate with
// external frame start trigger signals)
Camera.AcquisitionFrameRateEnable.SetValue( false );
// Select the frame start trigger
Camera.TriggerSelector.SetValue( TriggerSelector_FrameStart );
// Set the mode for the selected trigger
Camera.TriggerMode.SetValue( TriggerMode_On );
// Set the source for the selected trigger
Camera.TriggerSource.SetValue ( TriggerSource_Line1 );
// Set the trigger activation mode to rising edge
Camera.TriggerActivation.SetValue( TriggerActivation_RisingEdge );
// Set for the trigger width exposure mode
Camera.ExposureMode.SetValue( ExposureMode_TriggerWidth );
// Set the shortest exposure time -
// the shortest exposure time we plan to use is 1500 us
Camera.ExposureTimeAbs.SetValue( 1500 );
// Prepare for frame acquisition here
    Camera.AcquisitionStart.Execute( );
    while ( ! finished )
    {
        // Frame acquisition will start each time the externally generated
        // frame start trigger signal (ExFSTrig signal) goes high

        // Retrieve the captured frames
    }
    Camera.AcquisitionStop.Execute( );

```

You can also use the Basler pylon Viewer application to easily set the parameters.

For more information about the pylon API and the pylon Viewer, see Section 3 on [page 21](#).

## 7.5 Setting the Exposure Time



This section (Section 7.5) describes how the exposure time can be adjusted "manually", i.e., by setting the value of the exposure time parameter.

The camera also has an Exposure Auto function that can automatically adjust the exposure time. **Manual adjustment of the exposure time parameter will only work correctly if the Exposure Auto function is disabled.**

For more information about

- auto functions in general, see Section 10.7 on [page 164](#).
- the Exposure Auto function in particular, see Section 10.7.6 on [page 175](#).

Note that on cameras delivered from the factory, all auto functions will become disabled whenever you power on or reset the camera.

If you are operating the camera in any one of the following ways, you must specify an exposure time by setting the camera's Exposure Time Abs parameter:

- the frame start trigger mode is set to off
- the frame start trigger mode is set to on and the trigger source is set to software
- the frame start trigger mode is set to on, the trigger source is set to input line 1 or line 2, and the exposure mode is set to timed.

The Exposure Time Abs parameter must be set within a certain range. The minimum and maximum settings for each camera model are shown in Table 5.

Camera Model	Minimum Allowed Exposure Time	Maximum Possible Exposure Time
avA1000-100gm/gc	12 $\mu$ s	2500000 $\mu$ s
avA1600-50gm/gc	12 $\mu$ s	2500000 $\mu$ s
avA1900-50gm/gc	12 $\mu$ s	2500000 $\mu$ s
avA2300-25gm/gc	18 $\mu$ s	2500000 $\mu$ s

Table 5: Minimum Allowed Exposure Time Setting and Maximum Possible Exposure Time Setting

The Exposure Time Abs parameter sets the exposure time in  $\mu$ s. The parameter can be set in increments of 1  $\mu$ s.

You can use the Basler pylon API to set the Exposure Time Abs parameter value from within your application software. The following code snippet illustrates using the API to set the parameter value:

```
// Set the exposure time to 3000  $\mu$ s
Camera.ExposureTimeAbs.SetValue( 3000 );
```

You can also use the Basler pylon Viewer application to easily set the parameter.

If you want to set exposure times that are longer than the maximum possible exposure time settings indicated in Table 5 you can use the trigger width mode.

For more information about the pylon API and the pylon Viewer, see Section 3 on [page 21](#).

## 7.6 Overlapping Exposure with Sensor Readout

The frame acquisition process on the camera includes two distinct parts. The first part is the exposure of the pixels in the imaging sensor. Once exposure is complete, the second part of the process – readout of the pixel values from the sensor – takes place. In regard to this frame acquisition process, there are two common ways for the camera to operate: with “non-overlapped” exposure and with “overlapped” exposure.

In the non-overlapped mode of operation, each time a frame is acquired the camera completes the entire exposure/readout process before acquisition of the next frame is started. The exposure for a new frame does not overlap the sensor readout for the previous frame. This situation is illustrated in Figure 26 with the camera set for the trigger width exposure mode.

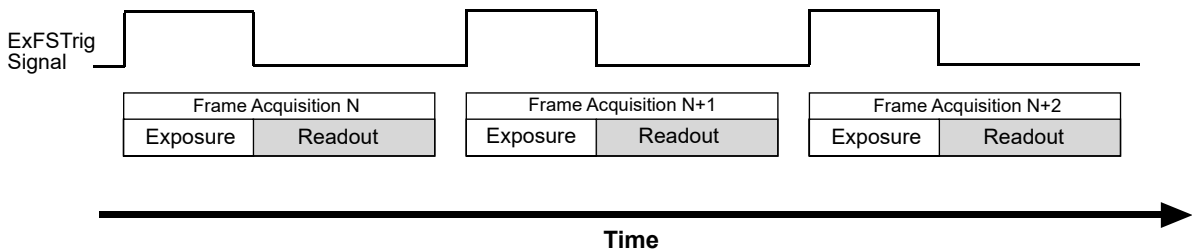

Fig. 26: Non-overlapped Exposure and Readout

In the overlapped mode of operation, the exposure of a new frame begins while the camera is still reading out the sensor data for the previously acquire frame. This situation is illustrated in Figure 27 with the camera set for the trigger width exposure mode.

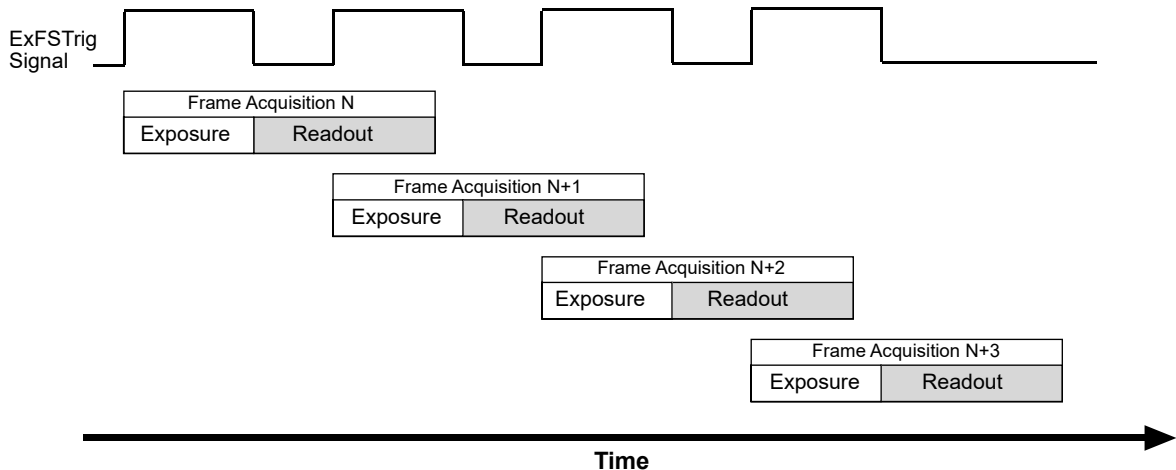

Fig. 27: Overlapped Exposure and Readout

Determining whether your camera is operating with overlapped or non-overlapped exposure and readout is not a matter of issuing a command or switching a setting on or off. Rather the way that you operate the camera will determine whether the exposures and readouts are overlapped or not. If we define the “frame period” as the time from the start of exposure for one frame acquisition to the start of exposure for the next frame acquisition, then:

- Exposure will not overlap when:  $\text{Frame Period} > \text{Exposure Time} + \text{Readout Time}$
- Exposure will overlap when:  $\text{Frame Period} \leq \text{Exposure Time} + \text{Readout Time}$

You can determine the readout time by reading the value of the Readout Time Abs parameter. The parameter indicates what the readout time will be in microseconds given the camera's current settings. You can read the Readout Time Abs parameter value from within your application software by using the Basler pylon API. The following code snippet illustrates using the API to get the parameter value:

```
double ReadoutTime = Camera.ReadoutTimeAbs.GetValue( );
```

You can also use the Basler pylon Viewer application to easily get the parameter value.

For more information about the pylon API and the pylon Viewer, see Section 3 on [page 21](#).

## Guidelines for Overlapped Exposure

If you will be operating the camera with overlapped exposure, there are two important guidelines to keep in mind:

- You must not begin the exposure time for a new image acquisition while the exposure time of the previous acquisition is in progress.
- You must not end the exposure time of the current image acquisition until readout of the previously acquired image is complete.

When you are operating a camera with overlapped exposure and using a hardware trigger signal to trigger image acquisition, you could use the camera's exposure time parameter settings and timing formulas to calculate when it is safe to begin each new acquisition. However, there is a much more convenient way to know when it safe to begin each acquisition. The camera supplies “trigger wait” signals that are specifically designed to let you trigger overlapped exposure safely and efficiently.

For more information about the trigger wait signals, see Section 7.7.3 on [page 87](#).

## 7.7 Acquisition Monitoring Tools

### 7.7.1 The Exposure Active Signal

The camera can provide an "exposure active" (ExpAc) output signal. The signal goes high when the exposure time for each frame acquisition begins and goes low when the exposure time ends as shown in Figure 28. This signal can be used as a flash trigger and is also useful when you are operating a system where either the camera or the object being imaged is movable. For example, assume that the camera is mounted on an arm mechanism and that the mechanism can move the camera to view different portions of a product assembly. Typically, you do not want the camera to move during exposure. In this case, you can monitor the ExpAc signal to know when exposure is taking place and thus know when to avoid moving the camera.

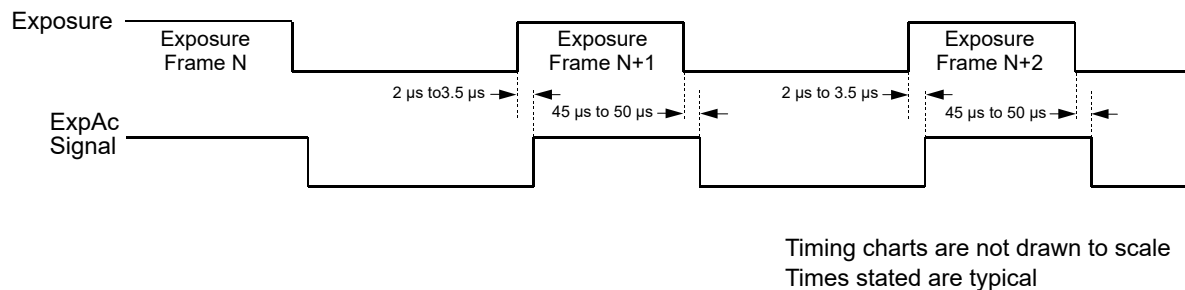

Fig. 28: Exposure Active Signal



When you use the exposure active signal, be aware that there is a delay in the rise and the fall of the signal in relation to the start and the end of exposure. See Figure 28 for details.

The exposure active output signal can be assigned to camera output line 1, output line 2, output line 3, or output line 4. For more information about changing which camera output signal is assigned to which output line, see Section 6.2 on [page 45](#).

For more information about the electrical characteristics of the camera's output lines, see Section 5.7 on [page 38](#).

## 7.7.2 Acquisition Status Indicator

If a camera receives a software acquisition start trigger signal when it is not in a "waiting for acquisition start trigger" acquisition status, it will simply ignore the trigger signal and will generate an acquisition start overtrigger event.

If a camera receives a software frame start trigger signal when it is not in a "waiting for frame start trigger" acquisition status, it will simply ignore the trigger signal and will generate a frame start overtrigger event.

The camera's acquisition status indicator gives you the ability to check whether the camera is in a "waiting for acquisition start trigger" acquisition status or in a "waiting for frame start trigger" acquisition status. If you check the acquisition status before you apply each software acquisition start trigger signal or each software frame start trigger signal, you can avoid applying trigger signals to the camera that will be ignored.

The acquisition status indicator is designed for use when you are using host control of image acquisition, i.e., when you are using software acquisition start and frame start trigger signals.

To determine the acquisition status of the camera via the Basler pylon API:

- Use the Acquisition Status Selector to select the Acquisition Trigger Wait status or the Frame Trigger Wait status.
- Read the value of the Acquisition Status parameter.
  - If the value is set to "false", the camera is not waiting for the trigger signal.
  - If the value is set to "true", the camera is waiting for the trigger signal.

You can check the acquisition status from within your application software by using the Basler pylon API. The following code snippet illustrates using the API to check the acquisition status:

```
// Check the acquisition start trigger acquisition status
// Set the acquisition status selector
Camera.AcquisitionStatusSelector.SetValue
( AcquisitionStatusSelector_AcquisitionTriggerWait );
// Read the acquisition status
bool IsWaitingForAcquisitionTrigger = Camera.AcquisitionStatus.GetValue();

// Check the frame start trigger acquisition status
// Set the acquisition status selector
Camera.AcquisitionStatusSelector.SetValue
( AcquisitionStatusSelector_FrameTriggerWait );
// Read the acquisition status
bool IsWaitingForFrameTrigger = Camera.AcquisitionStatus.GetValue();
```

You can also use the Basler pylon Viewer application to easily set the parameters.

For more information about the pylon API and the pylon Viewer, see Section 3 on [page 21](#).

## 7.7.3 Trigger Wait Signals

If a camera receives a hardware acquisition start trigger signal when it is not in a "waiting for acquisition start trigger" acquisition status, it will simply ignore the trigger signal and will generate an acquisition start overtrigger event.

If a camera receives a hardware frame start trigger signal when it is not in a "waiting for frame start trigger" acquisition status, it will simply ignore the trigger signal and will generate a frame start overtrigger event.

The camera's acquisition trigger wait signal gives you the ability to check whether the camera is in a "waiting for acquisition start trigger" acquisition status. If you check the acquisition trigger wait signal before you apply each hardware acquisition start trigger signal, you can avoid applying acquisition start trigger signals to the camera that will be ignored.

The camera's frame trigger wait signal gives you the ability to check whether the camera is in a "waiting for frame start trigger" acquisition status. If you check the frame trigger wait signal before you apply each hardware frame start trigger signal, you can avoid applying frame start trigger signals to the camera that will be ignored.

These signals are designed to be used when you are triggering acquisition start or frame start via a hardware trigger signal.

### 7.7.3.1 Acquisition Trigger Wait Signal

As you are acquiring frames, the camera automatically monitors the acquisition start trigger status and supplies a signal that indicates the current status. The Acquisition Trigger Wait signal will go high whenever the camera enters a "waiting for acquisition start trigger" status. The signal will go low when an external acquisition start trigger (ExASTrig) signal is applied to the camera and the camera exits the "waiting for acquisition start trigger status". The signal will go high again when the camera again enters a "waiting for acquisition trigger" status and it is safe to apply the next acquisition start trigger signal.

If you base your use of the ExASTrig signal on the state of the acquisition trigger wait signal, you can avoid "acquisition start overtriggering", i.e., applying an acquisition start trigger signal to the camera when it is not in a "waiting for acquisition start trigger" acquisition status. If you do apply an acquisition start trigger signal to the camera when it is not ready to receive the signal, it will be ignored and an acquisition start overtrigger event will be reported.

Figure 29 illustrates the Acquisition Trigger Wait signal with the Acquisition Frame Count parameter set to 3 and with exposure and readout overlapped. The figure assumes that the trigger mode for the frame start trigger is set to off, so the camera is internally generating frame start trigger signals.



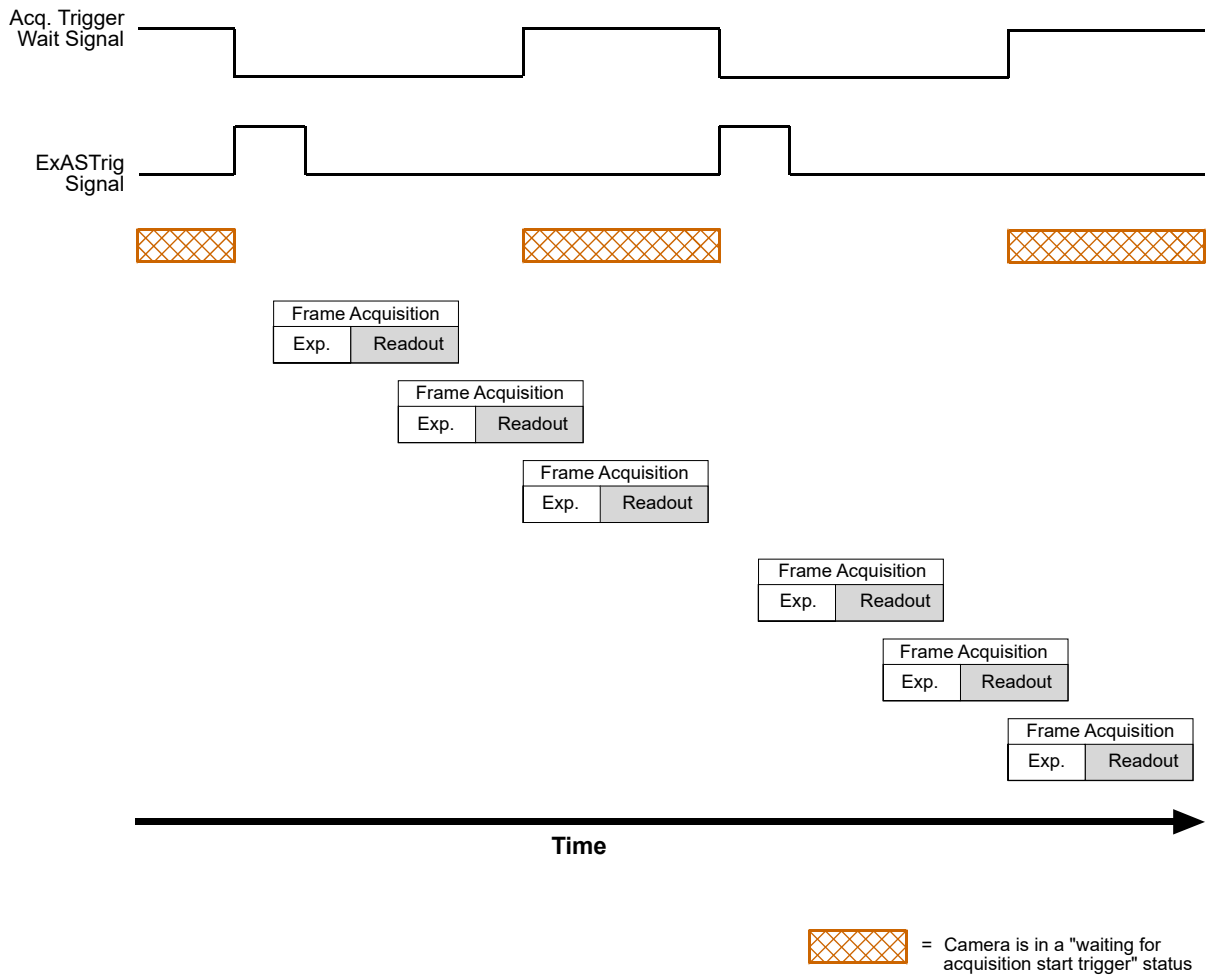



Fig. 29: Acquisition Trigger Wait Signal

 The acquisition trigger wait signal will only be available when hardware acquisition start triggering is enabled.

## Selecting the Acquisition Trigger Wait Signal as the Source Signal for the Output Line

The acquisition trigger wait signal can be selected to act as the source signal for camera output line 1, line 2, line 3, or line 4. Selecting a source signal for an output line is a two step process:

- Use the Line Selector to select output line 1, line 2, line 3, or line 4.
- Set the value of the Line Source Parameter to the acquisition trigger wait signal.

You can set the Line Selector and the Line Source parameter value from within your application software by using the Basler pylon API. The following code snippet illustrates using the API to set the selector and the parameter value:

```
Camera.LineSelector.SetValue( LineSelector_Out1 );  
Camera.LineSource.SetValue( LineSource_AcquisitionTriggerWait );
```

You can also use the Basler pylon Viewer application to easily set the parameters.

For more information about the pylon API and the pylon Viewer, see Section 3 on [page 21](#).

### 7.7.3.2 Frame Trigger Wait Signal

#### Overview

As you are acquiring frames, the camera automatically monitors the frame start trigger status and supplies a signal that indicates the current status. The Frame Trigger Wait signal will go high whenever the camera enters a "waiting for frame start trigger" status. The signal will go low when an external frame start trigger (ExFSTrig) signal is applied to the camera and the camera exits the "waiting for frame start trigger status". The signal will go high again when the camera again enters a "waiting for frame trigger" status and it is safe to apply the next frame start trigger signal.

If you base your use of the ExFSTrig signal on the state of the frame trigger wait signal, you can avoid "frame start overtriggering", i.e., applying a frame start trigger signal to the camera when it is not in a "waiting for frame start trigger" acquisition status. If you do apply a frame start trigger signal to the camera when it is not ready to receive the signal, it will be ignored and a frame start overtrigger event will be reported.

Figure 30 illustrates the Frame Trigger Wait signal. The camera is set for the trigger width exposure mode with rising edge triggering and with exposure and readout overlapped.

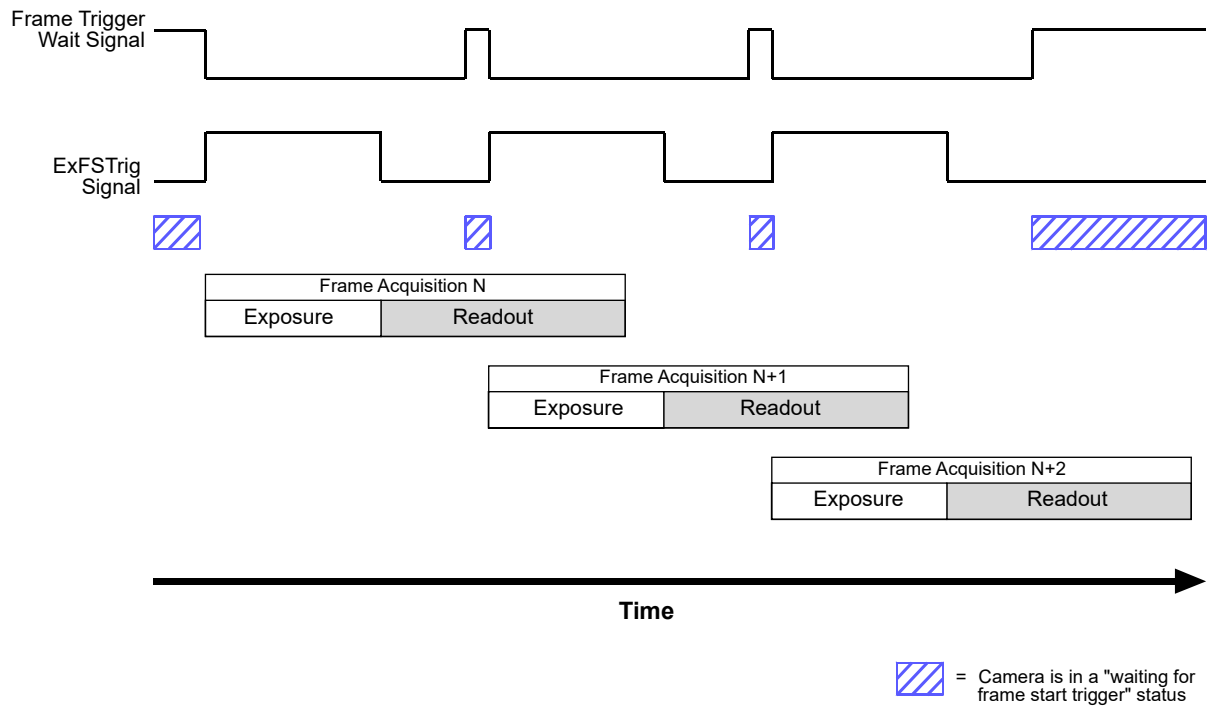

Fig. 30: Frame Trigger Wait Signal



The frame trigger wait signal will only be available when hardware frame start triggering is enabled.

## Selecting the Frame Trigger Wait Signal as the Source Signal for an Output Line

The frame trigger wait signal can be selected to act as the source signal for camera output line 1, line 2, line 3, or line 4. Selecting a source signal for an output line is a two step process:

- Use the Line Selector to select output line 1, line 2, line 3, or line 4.
- Set the value of the Line Source Parameter to the frame trigger wait signal.

You can set the Line Selector and the Line Source parameter value from within your application software by using the Basler pylon API. The following code snippet illustrates using the API to set the selector and the parameter value:

```
Camera.LineSelector.SetValue( LineSelector_Out1 );
Camera.LineSource.SetValue( LineSource_FrameTriggerWait );
```

You can also use the Basler pylon Viewer application to easily set the parameters.

For more information about the pylon API and the pylon Viewer, see Section 3 on [page 21](#).

## 7.8 Acquisition Timing Chart

Figure 31 shows a timing chart for frame acquisition and transmission. The chart assumes that exposure is triggered by an externally generated frame start trigger (ExFSTrig) signal with rising edge activation and that the camera is set for the timed exposure mode.

As Figure 31 shows, there is a slight delay between the rise of the ExFSTrig signal and the start of exposure. After the exposure time for a frame acquisition is complete, the camera begins reading out the acquired frame data from the imaging sensor into a buffer in the camera. When the camera has determined that a sufficient amount of frame data has accumulated in the buffer, it will begin transmitting the data from the camera to the host PC.

This buffering technique avoids the need to exactly synchronize the clock used for sensor readout with the data transmission over your Ethernet network. The camera will begin transmitting data when it has determined that it can safely do so without over-running or under-running the buffer. This buffering technique is also an important element in achieving the highest possible frame rate with the best image quality.

The **exposure start delay** is the amount of time between the point where the trigger signal transitions and the point where exposure actually begins.

The **frame readout time** is the amount of time it takes to read out the data for an acquired frame from the imaging sensor into the frame buffer.

The **frame transmission time** is the amount of time it takes to transmit an acquired frame from the buffer in the camera to the host PC via the network.

The **transmission start delay** is the amount of time between the point where the camera begins reading out the acquired frame data from the sensor to the point where it begins transmitting the data for the acquired frame from the buffer to the host PC.

The exposure start delay varies from camera model to camera model. The table below shows the exposure start delay for each camera model:

Camera Model	Exposure Start Delay	Camera Model	Exposure Start Delay
avA1000-100gm/gc	37 $\mu$ s	avA1900-50gm/gc	60 $\mu$ s
avA1600-50gm/gc	52 $\mu$ s	avA2300-25gm/gc	71 $\mu$ s

Table 6: Exposure Start Delays

Note that, if the debouncer feature is used, the debouncer setting for the input line must be added to the exposure start delays shown in Table 6 to determine the total start delay. For example, assume that you are using an avA1000-100 camera and that you have set the camera for hardware triggering. Also assume that you have selected input line 1 to accept the hardware trigger signal and that you have set the Line Debouncer Time Abs parameter for input line 1 to 15  $\mu$ s.

In this case:

Total Start Delay = Start Delay from Table 6 + Debouncer Setting

Total Start Delay = 37  $\mu$ s+ 15  $\mu$ s

Total Start Delay = 52  $\mu$ s

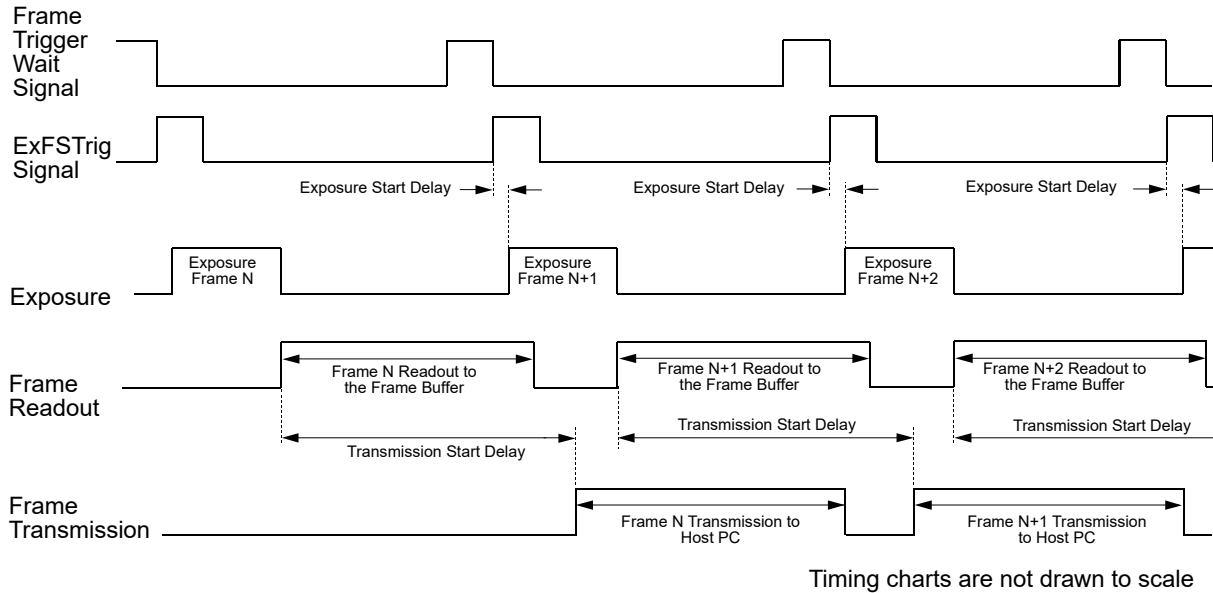

Timing charts are not drawn to scale

Fig. 31: Exposure Start Controlled with an ExFSTrig Signal

You can determine the readout time by reading the value of the Readout Time Abs parameter. The parameter indicates what the readout time will be in microseconds given the camera's current settings. You can read the Readout Time Abs parameter value from within your application software by using the Basler pylon API. The following code snippet illustrates using the API to get the parameter value:

```
double ReadoutTime = Camera.ReadoutTimeAbs.GetValue( );
```

You can also use the Basler pylon Viewer application to easily get the parameter value.

For more information about the pylon Viewer, see Section 3.1.1 on [page 22](#).

You can calculate an approximate frame transmission time by using this formula:

$$\sim \text{Frame Transmission Time} = \frac{\text{Payload Size Parameter Value}}{\text{Device Current Throughput Parameter Value}}$$

Note that this is an approximate frame transmission time. Due to the nature of the Ethernet network, the transmission time could vary. Also note that the frame transmission cannot be less than the frame readout time. So if the frame transmission time formula returns a value that is less than the readout time, the approximate frame transmission time will be equal to the readout time.

Due to the nature of the Ethernet network, the transmission start delay can vary from frame to frame. The transmission start delay, however, is of very low significance when compared to the transmission time.

For more information about the Payload Size and Device Current Throughput parameters, see Section B.1 on [page 285](#).

## 7.9 Maximum Allowed Frame Rate

In general, the maximum allowed acquisition frame rate on any aviator camera may be limited by several factors:

- The amount of time that it takes to transmit an acquired frame from the camera to your host PC. The amount of time needed to transmit a frame depends on the bandwidth assigned to the camera.
- The setting for the sensor digitization taps feature. If this feature is set for four taps, you will be able to acquire frames at a higher rate than if it is set to one tap.
- The binning feature. If binning is enabled, the maximum allowed frame rate will increase.
- The setting for the prelines feature. If you use a higher prelines setting, you can acquire fewer frames per second. (This is especially true when a small AOI is used).
- The amount of time it takes to read an acquired frame out of the imaging sensor and into the camera's frame buffer. This time varies depending on the height of the frame. Frames with a smaller height take less time to read out of the sensor. The frame height is determined by the camera's AOI Height settings.
- The exposure time for acquired frames. If you use very long exposure times, you can acquire fewer frames per second.

There are two ways that you can determine the maximum allowed acquisition frame rate with your current camera settings:

- You can use the online frame rate calculator found in the Support section of the Basler website:  
[www.baslerweb.com](http://www.baslerweb.com)
- You can use the Basler pylon API to read the value of the camera's Resulting Frame Rate Abs parameter (see the next page).



Note that the maximum allowed frame rate decreases if the Image AOI is significantly displaced from the sensor's center. This is particularly true for a displacement towards the upper part of the sensor.



When the camera's acquisition mode is set to single frame, the maximum possible acquisition frame rate for a given AOI cannot be achieved. This is true because the camera performs a complete internal setup cycle for each single frame and because it cannot be operated with "overlapped" exposure.

To achieve the maximum possible acquisition frame rate, set the camera for the continuous acquisition mode and use "overlapped" exposure.

For more information about overlapped exposure, see Section 7.6 on [page 83](#).

## 7.9.1 Using Basler pylon to Check the Maximum Allowed Frame Rate

You can use the Basler pylon API to read the current value of the Resulting Frame Rate Abs parameter from within your application software using the Basler pylon API. The following code snippet illustrates using the API to get the parameter value:

```
// Get the resulting frame rate
double resultingFps = Camera.ResultingFrameRateAbs.GetValue();
```

The Resulting Frame Rate Abs parameter takes all camera settings that can influence the frame rate into account and indicates the maximum allowed frame rate given the current settings.

You can also use the Basler pylon Viewer application to easily read the parameter.

For more information about the pylon Viewer, see Section 3.1.1 on [page 22](#).

## 7.9.2 Increasing the Maximum Allowed Frame Rate

You may find that you would like to acquire frames at a rate higher than the maximum allowed with the camera's current settings. In this case, you must adjust one or more of the factors that can influence the maximum allowed rate and then check to see if the maximum allowed rate has increased:

- The time that it takes to transmit a frame out of the camera is the main limiting factor on the frame rate. You can decrease the frame transmission time (and thus increase the maximum allowed frame rate) by doing one or more of the following:
  - Use an 8 bit pixel data format rather than a 12 bit pixel format. Images with less bits per pixel will take less time to transmit.
  - Use a smaller AOI. Decreasing the AOI means that the camera has less data to transmit and therefore the transmission time will decrease.
  - Use binning. When pixels are binned, there is less data to transmit and therefore the transmission time will decrease.
  - Make sure that the Packet Size parameter is set as high as possible for your system and that the Inter-Packet delay parameter is set as low as possible.
- If you have the sensor digitization feature set to one, consider changing the value to four. This will usually increase the maximum allowed frame rate.
- Lowering the setting for the prelines feature can increase the maximum allowed frame rate (this is especially true if the AOI is small). However, lowering the setting can also have a negative impact on image quality, especially if your AOI height is small. So changing the prelines setting may involve a trade-off between increasing the maximum allowed frame rate and lowering image quality.
- If you are using normal exposure times and you are using the camera at its maximum resolution, your exposure time will not normally restrict the frame rate. However, if you are using long exposure times or small areas of interest, it is possible that your exposure time is limiting the maximum allowed frame rate. If you are using a long exposure time or a small AOI,

try using a shorter exposure time and see if the maximum allowed frame rate increases. (You may need to compensate for a lower exposure time by using a brighter light source or increasing the opening of your lens aperture.)



An important thing to keep in mind is a common mistake new camera users frequently make when they are working with exposure time. They will often use a very long exposure time without realizing that this can severely limit the camera's maximum allowed frame rate. As an example, assume that your camera is set to use a 1/2 second exposure time. In this case, because each frame acquisition will take at least 1/2 second to be completed, the camera will only be able to acquire a maximum of two frames per second. Even if the camera's nominal maximum frame rate is, for example, 100 frames per second, it will only be able to acquire two frames per second because the exposure time is set much higher than normal.

For more information about

- pixel formats, Section 9 on [page 123](#).
- the sensor digitization taps feature, see Section 10.1 on [page 144](#).
- AOI settings, see Section 10.6 on [page 159](#).
- the prelines feature, see Section 10.6.2 on [page 162](#).
- the exposure time, see Section 7.5 on [page 82](#).
- the packet size and inter-packet delay settings and about the settings that determine the bandwidth assigned to the camera, see Section B.2 on [page 292](#).
- binning, see Section 10.11 on [page 223](#).



## 7.10 Use Case Descriptions and Diagrams

The following pages contain a series of use case descriptions and diagrams. The descriptions and diagrams are designed to illustrate how acquisition start triggering and frame start triggering work in some common situations and with some common combinations of parameter settings.

These use cases do not represent every possible combination of the parameters associated with acquisition start and frame start triggering. They are simply intended to aid you in developing an initial understanding of how these two triggers interact.

In each use case diagram, the black box in the upper left corner indicates how the parameters are set.



The use case diagrams are representational. They are not drawn to scale and are not designed to accurately describe precise camera timings.

### Use Case 1 - Acquisition and Frame Start Triggers Both Off (Free Run)

Use case one is illustrated on [page 97](#).

In this use case, the Acquisition Mode parameter is set to continuous. The Trigger Mode parameter for the acquisition start trigger and the Trigger Mode parameter for the frame start trigger are both set to off. The camera will generate all required acquisition start and frame start trigger signals internally. When the camera is set this way, it will constantly acquire images without any need for triggering by the user. This use case is commonly referred to as "free run".

The rate at which the camera will acquire images will be determined by the camera's Acquisition Frame Rate Abs parameter unless the current camera settings result in a lower frame rate. If the Acquisition Frame Rate Abs parameter is disabled, the camera will acquire frames at the maximum allowed frame rate.

Cameras are used in free run for many applications. One example is for aerial photography. A camera set for free run is used to capture a continuous series of images as an aircraft overflies an area. The images can then be used for a variety of purposes including vegetation coverage estimates, archaeological site identification, etc.

For more information about the Acquisition Frame Rate Abs parameter, see Section 7.3.1.1 on [page 62](#).

**Use Case:** "Free Run" (Acquisition Start Trigger Off and Frame Start Trigger Off)  
 The acquisition start trigger is off. The camera will generate acquisition start trigger signals internally with no action by the user.  
 The frame start trigger is off. The camera will generate frame start trigger signals internally with no action by the user.

**Settings:** Acquisition Mode = Continuous  
 Trigger Mode for the acquisition start trigger = Off  
 Trigger Mode for the frame start trigger = Off

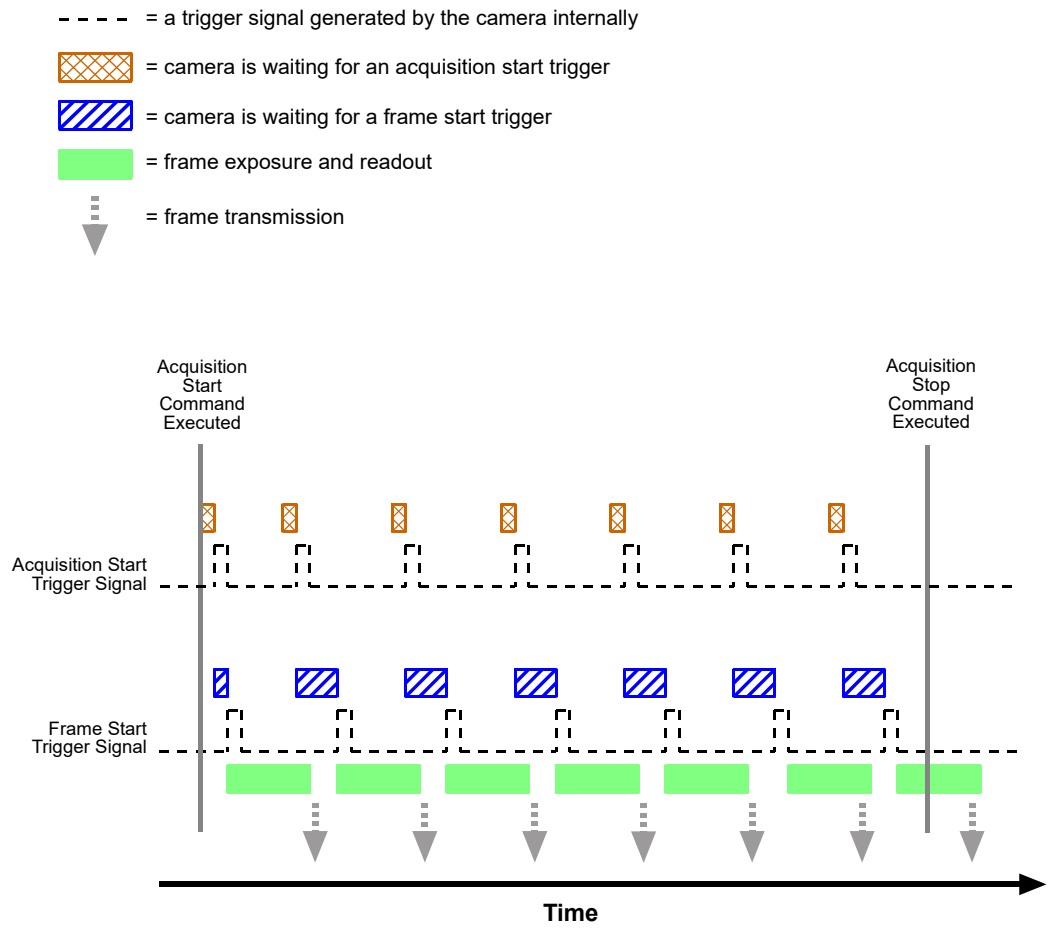

Fig. 32: Use Case 1 - Acquisition Start Trigger Off and Frame Start Trigger Off

## Use Case 2 - Acquisition Start Trigger Off - Frame Start Trigger On

Use case two is illustrated on [page 99](#).

In this use case, the Acquisition Mode parameter is set to continuous. The Trigger Mode parameter for the acquisition start trigger is set to off and the Trigger Mode parameter for the frame start trigger is set to on.





Because the acquisition start trigger is set to off, the user does not need to apply acquisition start trigger signals to the camera. The camera will generate all required acquisition start trigger signals internally.

Because the frame start trigger is set to on, the user must apply a frame start trigger signal to the camera in order to begin each frame exposure. In this case, we have set the frame start trigger signal source to input line 1 and the activation to rising edge, so the rising edge of an externally generated electrical signal applied to line 1 will serve as the frame start trigger signal.

This type of camera setup is used frequently in industrial applications. One example might be a wood products inspection system used to inspect the surface of pieces of plywood on a conveyor belt as they pass by a camera. In this situation, a sensing device is usually used to determine when a piece of plywood on the conveyor is properly positioned in front of the camera. When the plywood is in the correct position, the sensing device transmits an electrical signal to input line 1 on the camera. When the electrical signal is received on line 1, it serves as a frame start trigger signal and initiates a frame acquisition. The frame acquired by the camera is forwarded to an image processing system, which will inspect the image and determine if there are any defects in the plywood's surface.

**Use Case:** Acquisition Start Trigger Off and Frame Start Trigger On  
 The acquisition start trigger is off. The camera will generate acquisition start trigger signals internally with no action by the user.  
 The frame start trigger is on, and the frame start trigger source is set to input line 1. The user must apply a frame start trigger signal to input line 1 to start each frame exposure.

**Settings:** Acquisition Mode = Continuous  
 Trigger Mode for the acquisition start trigger = Off  
 Trigger Mode for the frame start trigger = On  
 Trigger Source for the frame start trigger = Line 1  
 Trigger Activation for the frame start trigger = Rising Edge

- - - - = a trigger signal generated by the camera internally
- = a trigger signal applied by the user
-  = camera is waiting for an acquisition start trigger signal
-  = camera is waiting for a frame start trigger signal
-  = frame exposure and readout
-  = frame transmission

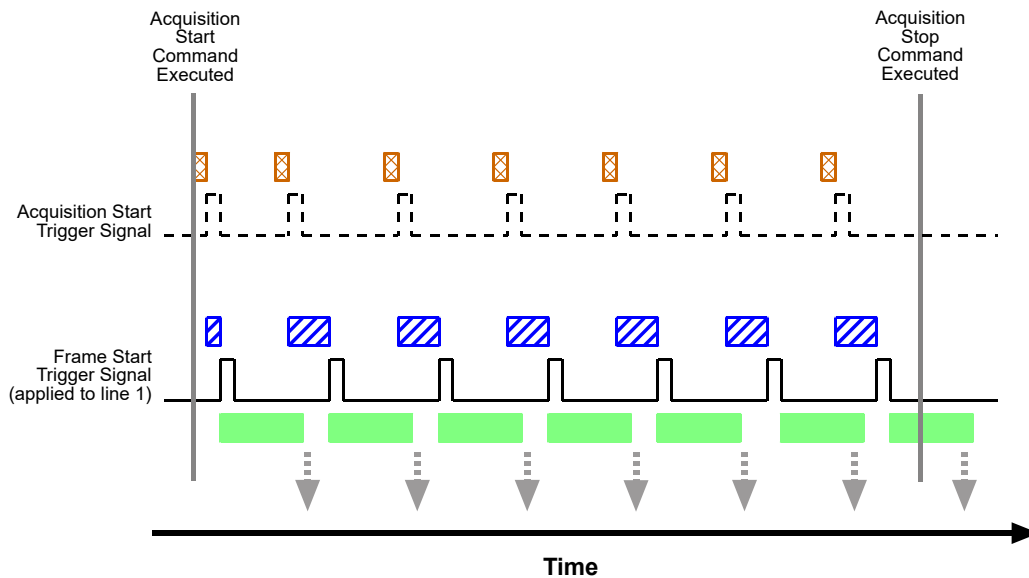

Fig. 33: Use Case 2 - Acquisition Start Trigger Off and Frame Start Trigger On

Use Case 3 - Acquisition Start Trigger On - Frame Start Trigger Off

Use case three is illustrated on [page 101](#).

In this use case, the Acquisition Mode parameter is set to continuous. The Trigger Mode parameter for the acquisition start trigger is set to on and the Trigger Mode parameter for the frame start trigger is set to off.

Because the acquisition start trigger mode is set to on, the user must apply an acquisition start trigger signal to the camera. In this case, we have set the acquisition start trigger signal source to input line 1 and the activation to rising edge, so an externally generated electrical signal applied to input line 1 will serve as the acquisition start trigger signal. The Acquisition Frame Count parameter has been set to 3.

When a rising edge of the electrical signal is applied to input line 1, the camera will exit the "waiting for acquisition start trigger" acquisition status and enter a "waiting for frame start trigger" acquisition status. Once the camera has acquired 3 frames, it will re-enter the "waiting for acquisition start trigger" acquisition status. Before any more frames can be acquired, a new rising edge must be applied to input line 1 to make the camera exit the "waiting for acquisition start trigger" acquisition status.

Because the frame start trigger is set to off, the user does not need to apply frame start trigger signals to the camera. The camera will generate all required frame start trigger signals internally. The rate at which the frame start trigger signals will be generated is normally determined by the camera's Acquisition Frame Rate Abs parameter. If the Acquisition Frame Rate Abs parameter is disabled, the camera will acquire frames at the maximum allowed frame rate.

This type of camera setup is used frequently in intelligent traffic systems. With these systems, a typical goal is to acquire several images of a car as it passes through a toll booth. A sensing device is usually placed at the start of the toll booth area. When a car enters the area, the sensing device applies an electrical signal to input line 1 on the camera. When the electrical signal is received on input line 1, it serves as an acquisition start trigger signal and the camera exits from the "waiting for acquisition start trigger" acquisition status and enters a "waiting for frame trigger" acquisition status. In our example, the next 3 frame start trigger signals internally generated by the camera would result in frame acquisitions. At that point, the number of frames acquired would be equal to the setting for the Acquisition Frame Count parameter. The camera would return to the "waiting for acquisition start trigger" acquisition status and would no longer react to frame start trigger signals. It would remain in this condition until the next car enters the booth area and activates the sensing device.

This sort of setup is very useful for traffic system applications because multiple frames can be acquired with only a single acquisition start trigger signal pulse and because frames will not be acquired when there are no cars passing through the booth (this avoids the need to store images of an empty toll booth area.)

For more information about the Acquisition Frame Rate Abs parameter, see [Section 7.3.1.1 on page 62](#).

**Use Case:** Acquisition Start Trigger On and Frame Start Trigger Off

The acquisition start trigger is on, and the acquisition start trigger source is set to input line 1. The user must apply an acquisition start trigger signal to input line 1 to make the camera exit the "waiting for acquisition start trigger" acquisition status. Because the acquisition frame count is set to 3, the camera will re-enter the "waiting for acquisition start trigger" acquisition status after 3 frames have been acquired.

The frame start trigger is off. The camera will generate frame start trigger signals internally with no action by the user.

**Settings:** Acquisition Mode = Continuous  
Trigger Mode for the acquisition start trigger = On  
Trigger Source for the acquisition start trigger = Line 1  
Trigger Activation for the acquisition start trigger = Rising Edge  
Acquisition Frame Count = 3  
Trigger Mode for the frame start trigger = Off

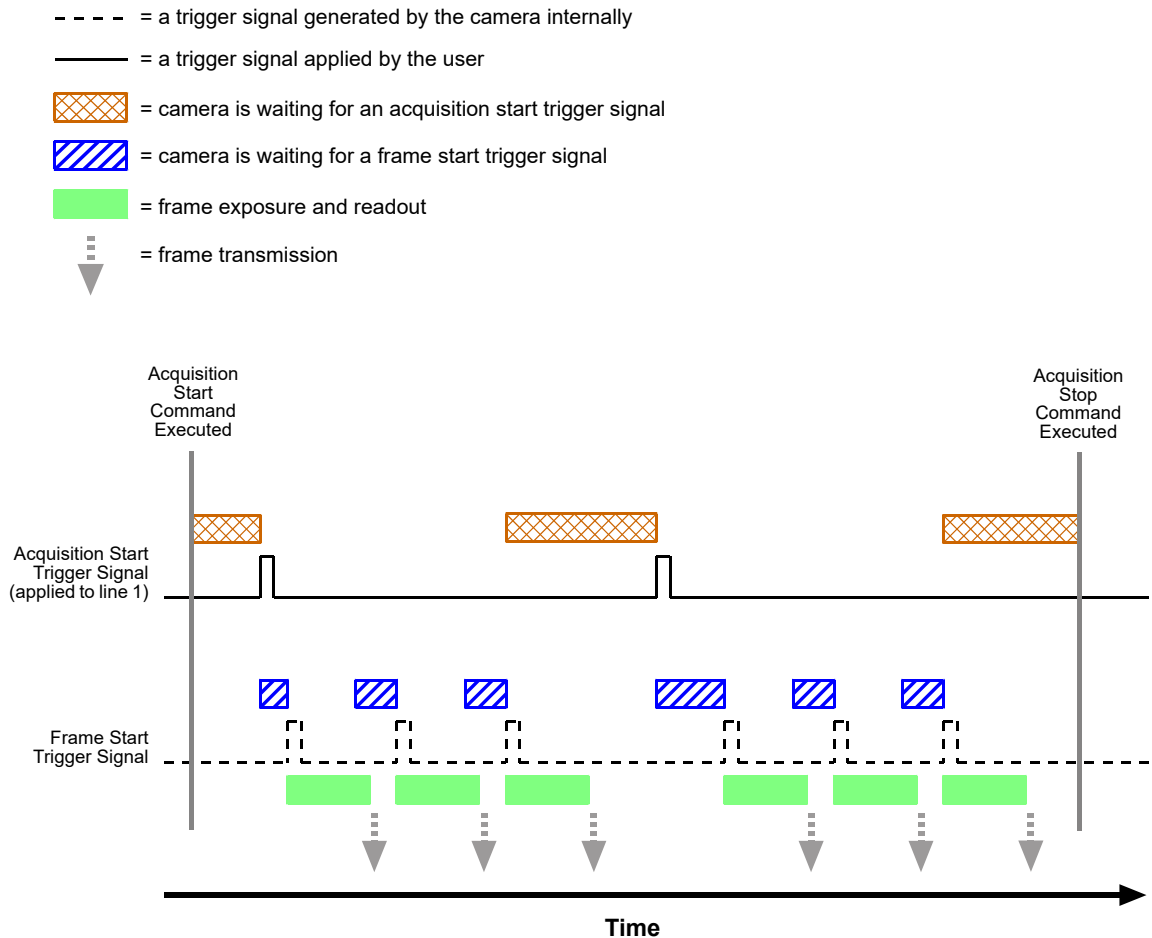

Fig. 34: Use Case 3 - Acquisition Start Trigger On and Frame Start Trigger Off

## Use Case 4 - Acquisition Start and Frame Start Triggers Both On

Use case four is illustrated on [page 103](#).

In this use case, the Acquisition Mode parameter is set to continuous. The Trigger Mode parameter for the acquisition start trigger is set to on and the Trigger Mode parameter for the frame start trigger is set to on.

Because the acquisition start trigger mode is set to on, the user must apply an acquisition start trigger signal to the camera. In this case, we have set the acquisition start trigger signal source to software, so the execution of an acquisition trigger software command will serve as the acquisition start trigger signal. The Acquisition Frame Count parameter is set to 3.

When an acquisition trigger software command is executed, the camera will exit the "waiting for acquisition start trigger" acquisition status and enter a "waiting for frame start trigger" acquisition status. Once the camera has acquired 3 frames, it will re-enter the "waiting for acquisition start trigger" acquisition status. Before any more frames can be acquired, a new acquisition trigger software command must be executed to make the camera exit the "waiting for acquisition start trigger" acquisition status.

Because the frame start trigger is set to on, the user must apply a frame start trigger signal to the camera in order to begin each frame acquisition. In this case, we have set the frame start trigger signal source to input line 1 and the activation to rising edge, so the rising edge of an externally generated electrical signal applied to input line 1 will serve as the frame start trigger signal. Keep in mind that the camera will only react to a frame start trigger signal when it is in a "waiting for frame start trigger" acquisition status.

A possible use for this type of setup is a conveyor system that moves objects past an inspection camera. Assume that the system operators want to acquire images of 3 specific areas on each object, that the conveyor speed varies, and that they do not want to acquire images when there is no object in front of the camera. A sensing device on the conveyor could be used in conjunction with a PC to determine when an object is starting to pass the camera. When an object is starting to pass, the PC will execute an acquisition start trigger software command, causing the camera to exit the "waiting for acquisition start trigger" acquisition status and enter a "waiting for frame start trigger" acquisition status.

An electrical device attached to the conveyor could be used to generate frame start trigger signals and to apply them to input line 1 on the camera. Assuming that this electrical device was based on a position encoder, it could account for the speed changes in the conveyor and ensure that frame trigger signals are generated and applied when specific areas of the object are in front of the camera. Once 3 frame start trigger signals have been received by the camera, the number of frames acquired would be equal to the setting for the Acquisition Frame Count parameter, and the camera would return to the "waiting for acquisition start trigger" acquisition status. Any frame start trigger signals generated at that point would be ignored.

This sort of setup is useful because it will only acquire frames when there is an object in front of the camera and it will ensure that the desired areas on the object are imaged. (Transmitting images of the "space" between the objects would be a waste of bandwidth and processing them would be a waste of processor resources.)

**Use Case:** Acquisition Start Trigger On and Frame Start Trigger On

The acquisition start trigger is on, and the acquisition start trigger source is set to software. The user must execute an acquisition start trigger software command to make the camera exit the "waiting for acquisition start trigger" acquisition status. Because the acquisition frame count is set to 3, the camera will re-enter the "waiting for acquisition start trigger" acquisition status after 3 frame trigger signals have been applied.

The frame start trigger is on, and the frame start trigger source is set to input line 1. The user must apply a frame start trigger signal to input line 1 to start each frame exposure.

**Settings:** Acquisition Mode = Continuous  
 Trigger Mode for the acquisition start trigger = On  
 Trigger Source for the acquisition start trigger = Software  
 Acquisition Frame Count = 3  
 Trigger Mode for the frame start trigger = On  
 Trigger Source for the frame start trigger = Line 1  
 Trigger Activation for the frame start trigger = Rising Edge

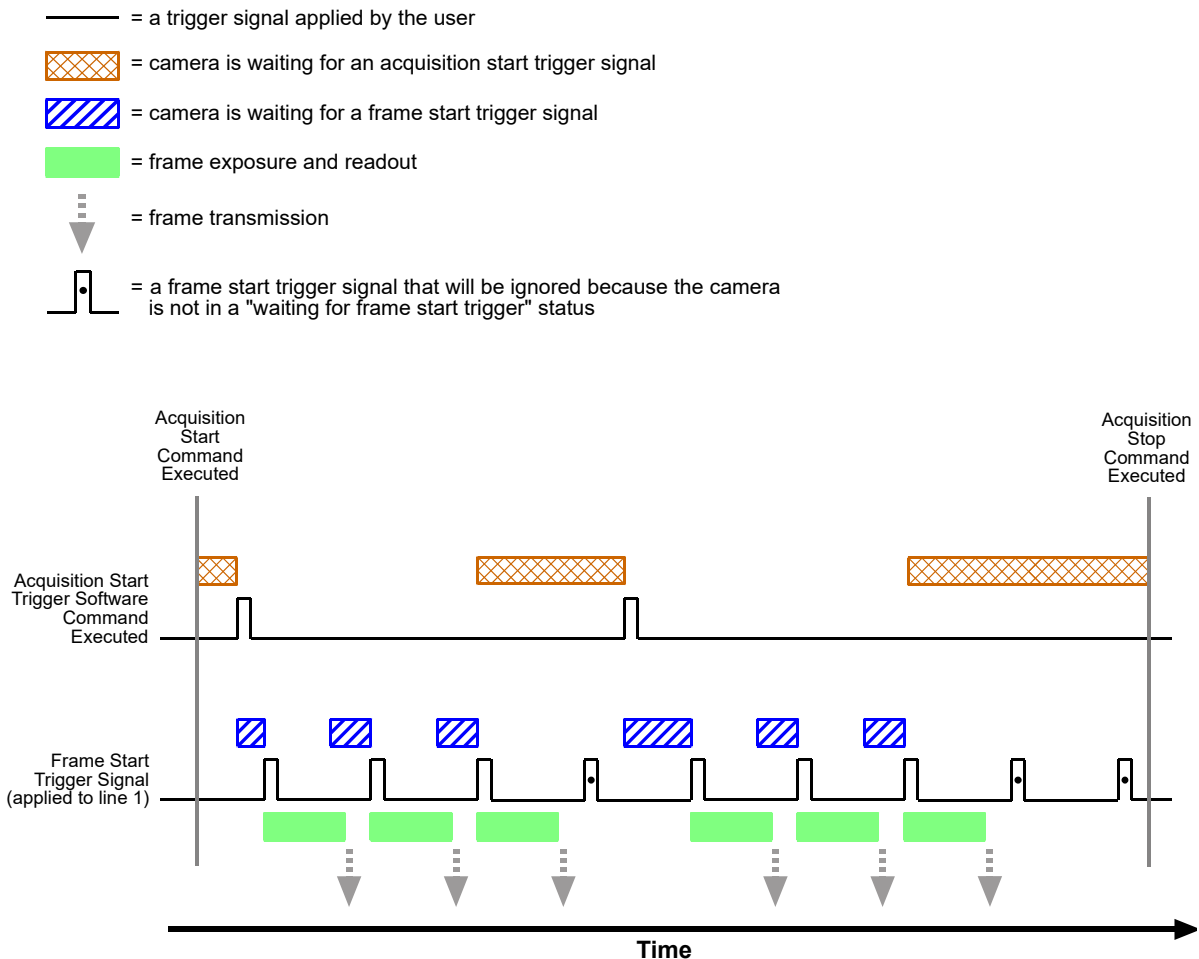

Fig. 35: Use Case 4 - Acquisition Start Trigger On and Frame Start Trigger On



# 8 Color Creation and Enhancement

This chapter provides information about how color images are created on color camera models and about the features available for adjusting the appearance of the colors.

## 8.1 Color Creation

The sensor used in the cameras is equipped with an additive color separation filter known as a Bayer filter. The pixel data output formats available on color cameras are related to the Bayer pattern, so you need a basic knowledge of the Bayer filter to understand the pixel formats. With the Bayer filter, each individual pixel is covered by a part of the filter that allows light of only one color to strike the pixel. The pattern of the Bayer filter used on the camera is as shown in Figure 36 (the alignment of the Bayer filter with respect to the sensor is shown as an example only; the figure shows the "GB" filter alignment). As the figure illustrates, within each square of four pixels, one pixel sees only red light, one sees only blue light, and two pixels see only green light. (This combination mimics the human eye's sensitivity to color.)

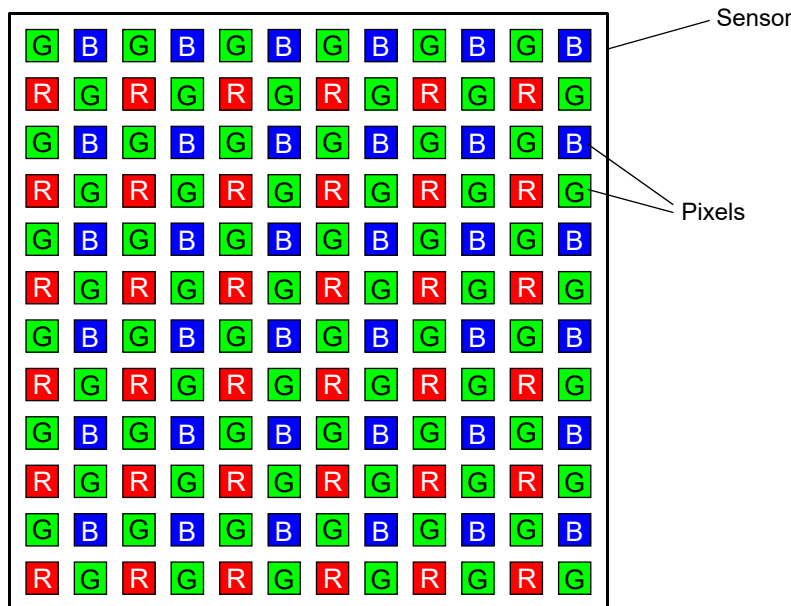

Fig. 36: Bayer Filter Pattern

## 8.1.1 Bayer Color Filter Alignment

On all color camera models that have sensors equipped with a Bayer filter, the alignment of the filter to the pixels in the acquired images is Bayer GB. Bayer GB alignment means that pixel one and pixel two of the first line in each image transmitted will be green and blue respectively. And for the second line transmitted, pixel one and pixel two will be red and green respectively. Since the pattern of the Bayer filter is fixed, you can use this information to determine the color of all of the other pixels in the image.

The Pixel Color Filter parameter indicates the current alignment of the camera's Bayer filter to the pixels in the images captured by a color camera. You can tell how the current AOI is aligned to the Bayer filter by reading the value of the Pixel Color Filter parameter.

Since the area of interest (AOI) width and height can only be changed in increments of 4 on color cameras, the alignment of the Bayer filter to the pixels in the transmitted images will stay the same regardless of the size of the AOI.

When either the reverse X feature or the reverse Y feature or both are used, the alignment of the color filter to the image remains Bayer GB. The camera includes a mechanism that keeps the filter alignment constant when these features are used.

For more information about

- the AOI feature, see Section 10.6 on [page 159](#).
- the reverse X and reverse Y features, see Section 10.12 on [page 227](#).

## 8.1.2 Pixel Formats Available on Cameras with a Bayer Filter

### Bayer Formats

Cameras equipped with a Bayer pattern color filter can output pixel data in the Bayer GB 8, the Bayer GB 12, or the Bayer GB 12 Packed pixel format. When a color camera is set for one of these three pixel data output formats, the pixel data is not processed or interpolated in any way. So, for each pixel covered with a red lens, you get 8 or 12 bits of red data. For each pixel covered with a green lens, you get 8 or 12 bits of green data. And for each pixel covered with a blue lens, you get 8 or 12 bits of blue data. (This type of pixel data is sometimes referred to as "raw" output.)

For complete details of these three pixel data output formats, see Section 9.3 on [page 131](#).

### YUV Formats

All color cameras with a Bayer filter can output pixel data in YUV 4:2:2 Packed format or in YUV 4:2:2 (YUYV) Packed format.

When a color camera is set for either of these formats, each pixel in the captured image goes through a two step conversion process as it exits the sensor and passes through the camera's electronics. This process yields Y, U, and V color information for each pixel.

In the first step of the process, a demosaicing algorithm is performed to get RGB data for each pixel. This is required because color cameras with a Bayer filter on the sensor gather only one color of light for each individual pixel.

The second step of the process is to convert the RGB information to the YUV color model. The conversion algorithm uses the following formulas:

$$Y = 0.30 R + 0.59 G + 0.11 B$$

$$U = -0.17 R - 0.33 G + 0.50 B$$

$$V = 0.50 R - 0.41 G - 0.09 B$$

Once the conversion to a YUV color model is complete, the pixel data is transmitted to the host PC.

For complete details of the YUV data output formats, see Section 9.3 on [page 131](#).

## **Mono Format**

Cameras equipped with a Bayer pattern color filter can output pixel data in the Mono 8 format.

When a color camera is set for Mono 8, the pixel values in each captured image are first demosaiced and converted to the YUV color model as described above. The camera then transmits the 8 bit Y value for each pixel to the host PC. In the YUV color model, the Y component for each pixel represents a brightness value. This brightness value can be considered as equivalent to the value that would be sent from a pixel in a monochrome camera. So in essence, when a color camera is set for Mono 8, it outputs an 8 bit monochrome image. (This type of output is sometimes referred to as "Y Mono 8".)

For complete details of the Mono 8 format on cameras with a Bayer filter, see Section 9.3.6 on [page 141](#).

## 8.2 Integrated IR Cut Filter (on Color Models)

Color models of the camera that have a C-mount lens adapter are equipped with an IR cut filter as standard equipment. The filter is mounted inside of the lens adapter. Cameras without an IR cut filter are available on request.

Monochrome cameras do not include an IR cut filter in the lens adapter. Monochrome cameras with a C-mount lens adapter can be equipped with a filter on request.

### **NOTICE**

On color cameras equipped with an IR cut filter, the lens thread length is limited.

Color models of the camera with a C-mount lens adapter are equipped with an IR cut filter mounted inside of the adapter. The location of this filter limits the length of the threads on any lens you use with the camera. If a lens with a very long thread length is used, the IR cut filter will be damaged or destroyed and the camera will no longer operate. Do not use a lens with a thread length greater than 7.5 mm.

For more information about the IR cut filter, see Section 1.5.3 on [page 11](#).

## 8.3 Color Enhancement Features

### 8.3.1 White Balance

The white balance feature lets you adjust the balance of red, green, and blue such that white objects in the camera's field of view appear white in the acquired images.

#### Setting the White Balance



This section (Section 8.3.1) describes how the camera's white balance can be adjusted "manually", i.e., by setting the value of the Balance Ratio Abs parameters for red, green, and blue.

The camera also has a White Balance Auto function that can automatically adjust the white balance. **Manual adjustment of the Balance Ratio Abs parameters for red, green, and blue will only work correctly if the Balance White Auto function is disabled.**

For more information about

- auto functions in general, see Section 10.7 on [page 164](#).
- the Balance White Auto function, see Section 10.7.9 on [page 179](#).

When you are using matrix color transformation and you set the Light Source Selector parameter to match your light source characteristics, the camera will automatically make adjustments to the white balance settings so that they are best suited for the light source you selected.

For more information about matrix color transformation, see Section 8.3.3 on [page 112](#) and Section 8.3.3 on [page 112](#).

With the white balancing scheme used on these cameras, the red intensity, green intensity, and blue intensity can be individually adjusted. For each color, a Balance Ratio Abs parameter is used to set the intensity of the color. If the Balance Ratio Abs parameter for a color is set to a value of 1, the intensity of the color will be unaffected by the white balance mechanism. If the ratio is set to a value lower than 1, the intensity of the color will be reduced. If the ratio is set to a value greater than 1, the intensity of the color will be increased. The increase or decrease in intensity is proportional. For example, if the Balance Ratio Abs for a color is set to 1.2, the intensity of that color will be increased by 20%.

The Balance Ratio Abs parameter value can range from 0.00 to 15.9844. But you should be aware that if you set the balance ratio for a color to a value lower than 1, this will not only decrease the intensity of that color relative to the other two colors, but will also decrease the maximum intensity that the color can achieve. For this reason, we don't normally recommend setting a balance ratio less than 1 unless you want to correct for the strong predominance of one color.

To set the Balance Ratio Abs parameter for a color:

- Set the Balance Ratio Selector to red, green, or blue.
- Set the Balance Ratio Abs parameter to the desired value for the selected color.

You can set the Balance Ratio Selector and the Balance Ratio Abs parameter value from within your application software by using the Basler pylon API. The following code snippet illustrates using the API to set the selector and the parameter value:

```
Camera.BalanceRatioSelector.SetValue( BalanceRatioSelector_Green );  
Camera.BalanceRatioAbs.SetValue( 1.20 );
```

You can also use the Basler pylon Viewer application to easily set the parameters.

For more information about the pylon API and the pylon Viewer, see Section 3 on [page 21](#).

## White Balance Reset

The camera includes a White Balance Reset command that can be used to reset the white balance adjustments. This feature is especially useful, if you have badly misadjusted the white balance and you want to quickly return to reasonable settings. When the reset command is used, it will return the camera to the settings defined by your current Light Source Selector parameter setting.

You can execute the White Balance Reset command from within your application software by using the pylon API. The following code snippet illustrates using the API to execute the command:

```
// Reset the white balance adjustments  
Camera.BalanceWhiteReset.Execute( );
```

You can also use the Basler pylon Viewer application to easily execute the command.

## 8.3.2 Gamma Correction

The gamma correction feature lets you modify the brightness of the pixel values output by the camera's sensor to account for a non-linearity in the human perception of brightness. There are two modes of gamma correction available on the camera: sRGB and User.

### sRGB Gamma

When the camera is set for sRGB gamma correction, it automatically sets the gamma correction to adjust the pixel values so that they are suitable for display on an sRGB monitor. If you will be displaying the images on an sRGB monitor, using this type of gamma correction is appropriate.

### User Gamma

With User type gamma correction, you can set the gamma correction value as desired.

To accomplish the correction, a gamma correction value ( $\gamma$ ) is applied to the brightness value ( $Y$ ) of each pixel according to the following formula:

$$Y_{\text{corrected}} = \left( \frac{Y_{\text{uncorrected}}}{Y_{\text{max}}} \right)^{\gamma} \times Y_{\text{max}}$$

The formula uses uncorrected and corrected pixel brightnesses that are normalized by the maximum pixel brightness. The maximum pixel brightness equals 255 for 8 bit output and 4095 for 12 bit output.

The gamma correction value can be set in a range from 0 to 3.99998.

When the gamma correction value is set to 1, the output pixel brightness will not be corrected.

A gamma correction value between 0 and 1 will result in increased overall brightness, and a gamma correction value greater than 1 will result in decreased overall brightness.

In all cases, black (output pixel brightness equals 0) and white (output pixel brightness equals 255 at 8 bit output and 4095 at 12 bit output) will not be corrected.

### Enabling Gamma Correction and Setting Gamma Using pylon

You can enable or disable the gamma correction feature by setting the value of the Gamma Enable parameter.

You can use the Gamma Selector to select either sRGB or user gamma correction.

If you select user gamma correction, you can use the Gamma parameter to set the gamma correction value.

You can set the Gamma Enable parameter, use the Gamma Selector, and set Gamma parameter values from within your application software by using the Basler pylon API. The following code snippet illustrates using the API to set the parameter values for sRGB type correction:

```
// Enable the Gamma feature
Camera.GammaEnable.SetValue( true );
// Set the gamma type to sRGB
Camera.GammaSelector.SetValue ( GammaSelector_sRGB );
```

The following code snippet illustrates using the API to set the parameter values for user type correction:

```
// Enable the Gamma feature
Camera.GammaEnable.SetValue( true );
// Set the gamma type to User
Camera.GammaSelector.SetValue ( GammaSelector_User );
// Set the Gamma value to 1.2
Camera.Gamma.SetValue( 1.2 );
```

You can also use the Basler pylon Viewer application to easily set the parameters.

For more information about the pylon API and the pylon Viewer, see Section 3.1.1 on [page 22](#).



## 8.3.3 Matrix Color Transformation on Color Models



If matrix color transformation is not available, activate the "Full" camera description file.

For more information, see Section 10.20 on [page 253](#).

### Introduction

The main objective of matrix color transformation is to make corrections to the color information that will account for the type of lighting used during image acquisition and to compensate for imperfections in the sensor's color generation process.

With the matrix color transformation, a first matrix transformation step ensures that the pixel values from the sensor are available in RGB color space, i.e. as R, G, or B component for each pixel. A second transformation step takes account of the specific pre-selected light source. The vector consisting of the R, G, or B component for each pixel in the image is multiplied by a matrix containing a set of correction values.

### Matrix Color Transformation Parameters

The initial parameter that you must consider when working with the matrix color transformation feature is the Processed Raw Enable parameter. If the camera is set to output pixel data in the Bayer xx format, then the Processed Raw Enable parameter must be set to "enabled" to allow color enhancements to be performed. Setting this parameter to enabled will allow the camera to perform color enhancements on the raw RGB data from the sensor and still be able to output the pixel data in one of the Bayer formats. If the camera is set for a Bayer xx pixel data output format and the Processed Raw Enable parameter is not set to enabled, the matrix color transformation feature and the color adjustment feature will have no effect on camera operation.

The first parameter associated with the matrix color transformation feature is the **Color Transformation Selector** parameter. This parameter is used to select the type of transformation that will be performed before color correction for a specific light source is performed (addressed by the second parameter). For cameras equipped with a Bayer pattern filter on the imaging sensor, RGB to RGB is the only setting available. This setting means that the matrix color transformation process will not transform the red, green, and blue pixel values from the sensor into a different color space.

The second parameter associated with matrix color transformation is the **Light Source Selector** parameter that defines different light source presets. The following settings are available for this parameter:

- Off - No alterations will be made to the pixel values, i.e. no color transformation and gamma is applied.
- Tungsten - This setting will automatically populate the matrix with a pre-selected set of values that will make appropriate corrections for images captured with tungsten lighting that has a color temperature of about 2500K to 3000K. When you select this setting, the camera will also

adjust the white balance settings and the color adjustment settings so that they are appropriate for a tungsten light source.

- Daylight - This setting will automatically populate the matrix with a pre-selected set of values that will make appropriate corrections for images captured with daylight lighting that has a color temperature of about 5000K. When you select this setting, the camera will also adjust the white balance settings and the color adjustment settings so that they are appropriate for a daylight light source with a color temperature of about 5000K.
- Daylight 6500K - This setting will automatically populate the matrix with a pre-selected set of values that will make appropriate corrections for images captured with daylight lighting that has a color temperature of about 6500K. When you select this setting, the camera will also adjust the white balance settings and the color adjustment settings so that they are appropriate for a daylight light source with a color temperature of about 6500K.
- Custom - The user can set the values in the matrix as desired. When you select this setting, the camera will also adjust the white balance settings and the color adjustment settings so that they have neutral values (line sum of coefficients = 1).

In almost all cases, selecting one of the settings that populate the matrix with pre-selected values will give you excellent results with regard to correcting the colors for the light source you are using.

The custom setting should only be used by someone who is thoroughly familiar with matrix color transformations. Instructions for using the custom setting appear in the next section.

The third parameter associated with matrix color transformation is the **Color Transformation Matrix Factor** parameter. This parameter determines how strong an effect the matrix correction function will have on the colors output by the camera. The parameter setting is a floating point value that can range from 0 to 1. When the parameter value is set to 0, matrix correction will have no effect. When the value is set to 1, matrix correction will have its maximum effect.

As an alternative, the Color Transformation Matrix Factor parameter value can be entered as an integer value on a scale ranging from 0 to 65536. This integer range maps linearly to the floating point range with 0 being equivalent to 0 and 65536 being equivalent to 1. The integer values can be entered using the Color transformation Matrix Factor Raw parameter.



When the Light Source Selector parameter is set to off or custom, the Color Transformation Matrix Factor parameter will not be available.

## Setting Matrix Color Transformation

You can set the Processed Raw Enable, Color Transformation Selector and Light Source Selector parameter values from within your application software by using the Basler pylon API.

In this example, we assume that you want to set your camera for Bayer BG 8 output, and therefore you must set the Processed Raw Enable parameter value to enabled.

The following code snippet illustrates using the API to set the parameter values:

```
// Set the camera for Bayer GR8 pixel data output format
Camera.PixelFormat.SetValue( PixelFormat_BayerGR8 );

// Because the camera is set for a Bayer output format, the Processed Raw
// Enabled parameter must be set to enabled
```

```

Camera.ProcessedRawEnable.SetValue( true );

// Select the matrix color transformation type
Camera.ColorTransformationSelector.SetValue
( ColorTransformationSelector_RGBtoRGB );

// Set the light source selector so that no correction will be done
Camera.LightSourceSelector.SetValue
( LightSourceSelector_Off );
// Set the light source selector for tungsten lighting
Camera.LightSourceSelector.SetValue
( LightSourceSelector_Tungsten );
// Set the light source selector for daylight (at about 5000K)
Camera.LightSourceSelector.SetValue
( LightSourceSelector_Daylight );
// Set the light source selector for daylight (at about 6500K)
Camera.LightSourceSelector.SetValue
( LightSourceSelector_Daylight6500K );

// Set the matrix correction factor
Camera.ColorTransformationMatrixFactor.SetValue( 0.50 );

```

You can also use the Basler pylon Viewer application to easily set the parameters.

For more information about the pylon API and the pylon Viewer, see Section 3 on [page 21](#).

### 8.3.3.1 The Custom Light Source Setting



The "Custom" setting for the Light Source Selector parameter is intended for use by someone who is thoroughly familiar with matrix color transformations. **It is nearly impossible to enter correct values in the conversion matrix by trial and error.**

The RGB to RGB color matrix conversion for each pixel is performed by multiplying a 1 x 3 matrix containing R, G, and B color values with a 3 x 3 matrix containing correction values. Each column in the 3 x 3 matrix can be populated with values of your choice. In other words:

$$\begin{bmatrix} \text{Gain00} & \text{Gain01} & \text{Gain02} \\ \text{Gain10} & \text{Gain11} & \text{Gain12} \\ \text{Gain20} & \text{Gain21} & \text{Gain22} \end{bmatrix} \begin{bmatrix} R \\ G \\ B \end{bmatrix} = \begin{bmatrix} R' \\ G' \\ B' \end{bmatrix}$$

Where Gain00, Gain01, etc. are settable values.

Each GainXY position can be populated with a floating point value ranging from -8.0 to +7.96875 by using the Color Transformation Value Selector to select one of the GainXY positions in the matrix and using the Color transformation Value parameter to enter a value for that position.

As an alternative the Gain XY values can each be entered as an integer value on a scale ranging from -256 to +255. This integer range maps linearly to the floating point range with -256 being equivalent to -8.0, 32 being equivalent to 1.0, and +255 being equivalent to +7.96875. The integer values can be entered using the Color transformation Value Raw parameter.

A reference article that explains the basics of color matrix transformation for video data can be found at:

<http://www.its.bldrdoc.gov/publications/2437.aspx>

## Setting Custom Matrix Values

You can set the Color Transformation Value Selector, Color Transformation Value, and Color Transformation Value Raw parameters from within your application software by using the Basler pylon API. The following code snippet illustrates using the API to set the values in the matrix. Note that the values in this example are just randomly selected numbers and do not represent values that you should actually use.

```
// Set the light source selector for custom
Camera.LightSourceSelector.SetValue ( LightSourceSelector_Custom );

// Select a position in the matrix
Camera.ColorTransformationValueSelector.SetValue
    ( ColorTransformationValueSelector_Gain01 );
// Set the value for the selected position as a floating point value
Camera.ColorTransformationValue.SetValue( 2.11 );

// Select a position in the matrix
Camera.ColorTransformationValueSelector.SetValue
    ( ColorTransformationValueSelector_Gain12 );
// Set the value for the selected position as an integer value
Camera.ColorTransformationValueRaw.SetValue( 135 );
```

You can also use the Basler pylon Viewer application to easily set the parameters.

## 8.3.4 Color Adjustment



If color adjustment is not available, activate the "Full" camera description file. For more information, see Section 10.20 on [page 253](#).

On all color cameras equipped with a Bayer pattern filter the pixel values output from the sensor reside in the RGB color space.

The camera's color adjustment feature lets you adjust hue and saturation for the primary and secondary colors in the RGB color space. Each adjustment affects those colors in the image where the adjusted primary or secondary color predominates. For example, the adjustment of red affects the colors in the image with a predominant red component.



For the color adjustments to work properly, the white balance must be correct. See Section 8.3.1 on [page 108](#) for more information about the white balance and see Section 8.3.5 on [page 121](#) for an overall procedure for setting the color enhancement features.



Although color adjustment can be used without also using color matrix transformation, we nonetheless strongly recommend to also use color matrix transformation to make full use of the camera's color enhancement capabilities. See Section 8.3.3 on [page 112](#) for more information about color matrix transformation.

### The RGB Color Space

The RGB color space includes light with the primary colors red, green, and blue and all of their combinations. When red, green, and blue light are combined and when the intensities of R, G, and B are allowed to vary independently between 0% and 100%, all colors within the RGB color space can be formed. Combining colored light is referred to as additive mixing.

When two primary colors are mixed at equal intensities, the secondary colors will result. The mixing of red and green light produces yellow light (Y), the mixing of green and blue light produces cyan light (C), and the mixing of blue and red light produces magenta light (M).

When the three primary colors are mixed at maximum intensities, white will result. In the absence of light, black will result.

The color space can be represented as a color cube (see Figure 37 on [page 117](#)) where the primary colors R, G, B, the secondary colors C, M, Y, and black and white define the corners. All shades of gray are represented by the line connecting the black and the white corner.

For ease of imagination, the color cube can be projected onto a plane (as shown in Figure 37) such that a color hexagon is formed. The primary and secondary colors define the corners of the color hexagon in an alternating fashion. The edges of the color hexagon represent the colors resulting from mixing the primary and secondary colors. The center of the color hexagon represents all shades of gray including black and white.

The representation of any arbitrary color of the RGB color space will lie within the color hexagon. The color will be characterized by its hue and saturation:

- Hue specifies the kind of coloration, for example, whether the color is red, yellow, orange etc.
- Saturation expresses the colorfulness of a color. At maximum saturation, no shade of gray is present. At minimum saturation, no "color" but only some shade of gray (including black and white) is present.

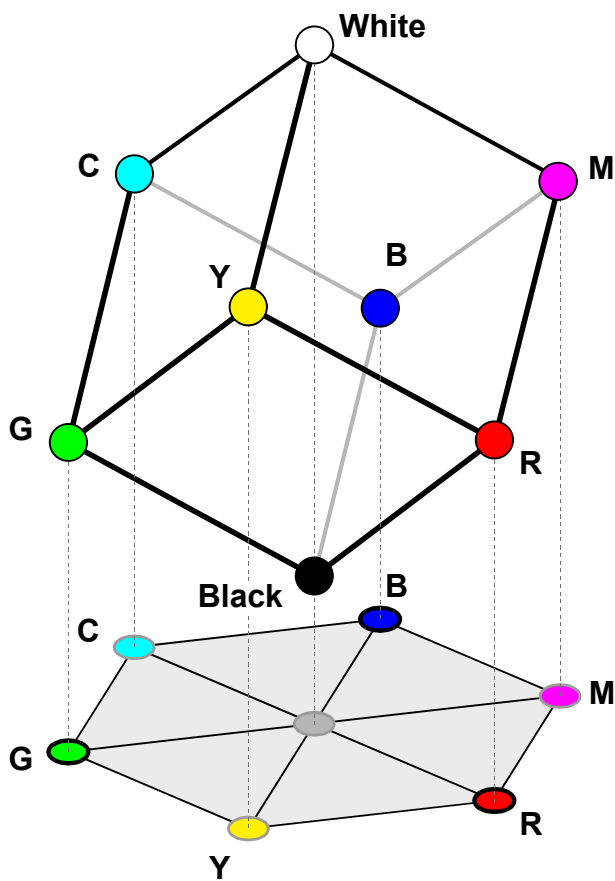

Fig. 37: RGB Color Cube With YCM Secondary Colors, Black, and White, Projected On a Plane

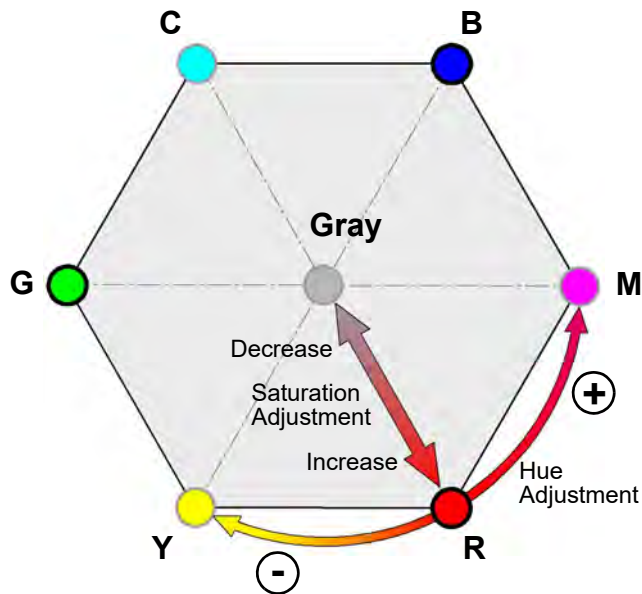

Fig. 38: Hue and Saturation Adjustment In the Color Hexagon. Adjustments Are Indicated for Red as an Example

## Hue and Saturation Adjustment

The color adjustment feature lets you adjust hue and saturation for the primary and the secondary colors. Each adjustment affects those areas in the image where the adjusted color predominates. For example, the adjustment of red affects the colors in the image with a predominantly red component.

Keep in mind that when you adjust a color, the colors on each side of it in the color hexagon will also be affected to some degree. For example, when you adjust red, yellow and magenta will also be affected.

- In the color hexagon, the adjustment of hue can be considered as a rotation between hues. Primary colors can be rotated towards, and as far as, their neighboring secondary colors. And secondary colors can be rotated towards, and as far as, their neighboring primary colors. For example, when red is rotated in negative direction towards yellow, then, for example, purple in the image can be changed to red and red in the image can be changed to orange. Red can be rotated as far as yellow, where red will be completely transformed into yellow. When red is rotated in a positive direction towards magenta, then, for example, orange in the image can be changed to red and red in the image can be changed to purple. Red can be rotated as far as magenta, where red will be completely transformed into magenta.
- Adjusting saturation changes the colorfulness (intensity) of a color. The color adjustment feature lets you adjust saturation for the primary and secondary colors. For example, if saturation for red is increased, the colorfulness of red colors in the image will increase. If red is set to minimum saturation, red will be replaced by gray for "red" colors in the image.

## Color Adjustment Parameters

The initial parameter that you must consider when working with the color adjustment feature is the Processed Raw Enable parameter. If you are working with a camera that is set to output pixel data in a Bayer xx format, then the Processed Raw Enabled parameter must be set to "enabled", if you want to use color enhancement. The camera will then be able to perform color enhancements on the raw RGB data from the sensor and still be able to output the pixel data in one of the Bayer formats. If the camera is set for a Bayer xx pixel data output format and the Processed Raw Enable parameter is not set to enabled, the matrix color transformation feature and the color adjustment feature will have no effect on the camera operation.

You can enable or disable the color adjustment feature by setting the value of the Color Adjustment Enable parameter to true or false.

You can use the Color Adjustment Selector parameter to select a color to adjust. The colors you can select are: red, yellow, green, cyan, blue, and magenta.

You can use the Color Adjustment Hue parameter to set the hue for the selected color as a floating point value in a range from -4.0 to +3.96875.

As an alternative, you can use the Color Adjustment Hue Raw parameter to set the hue as an integer value on a scale ranging from -128 to +127. This integer range maps linearly to the floating point range with -256 being equivalent to -4.0, 32 being equivalent to 1.0, and +255 being equivalent to +3.96875.

You can use the Color Adjustment Saturation parameter to set the saturation for the selected color as a floating point value in a range from 0.0 to +1.99219.

As an alternative, you can use the Color Adjustment Saturation Raw parameter to set the saturation as an integer value on a scale ranging from 0 to 255. This integer range maps linearly to the floating point range with 0 being equivalent to 0.0, 128 being equivalent to 1.0, and +255 being equivalent to +1.99219.

## Enabling and Setting Color Adjustment

You can set the Processed Raw Enable, Color Adjustment Enable, Color Adjustment Selector, Color Adjustment Hue, Color Adjustment Hue Raw, Color Adjustment Saturation, and Color Adjustment Saturation Raw parameter values from within your application software by using the Basler pylon API. In this example, we assume that you want to set your camera for Bayer BG8 output, and therefore you must set the Processed Raw Enable parameter value to enabled.

The following code snippet illustrates using the API to set the parameter values:

```
// Set the camera for Bayer BG8 pixel data output format
Camera.PixelFormat.SetValue( PixelFormat_BayerBG8 );
// Because the camera is set for a Bayer output format, the Processed Raw
// Enabled parameter must be set to enabled
Camera.ProcessedRawEnable.SetValue( true );

// Enable the Color Adjustment feature
```



```
Camera.ColorAdjustmentEnable.SetValue( true );

// Select red as the color to adjust
Camera.ColorAdjustmentSelector.SetValue( ColorAdjustmentSelector_Red );

// Set the red hue as a floating point value
Camera.ColorAdjustmentHue.SetValue( -1.125 );
// Set the red saturation as a floating point value
Camera.ColorAdjustmentSaturation.SetValue( 1.375 );

// Select cyan as the color to adjust
Camera.ColorAdjustmentSelector.SetValue( ColorAdjustmentSelector_Cyan );

// Set the cyan hue as an integer value
Camera.ColorAdjustmentHueRaw.SetValue( -36 );
// Set the cyan saturation as an integer value
Camera.ColorAdjustmentSaturationRaw.SetValue( 176 );
```

You can also use the Basler pylon Viewer application to easily set the parameters.

For more information about the pylon API and the pylon Viewer, see Section 3 on [page 21](#).

## Color Adjustment Reset

The camera includes a Color Adjustment Reset command that can be used to reset the color adjustments. This feature is especially useful, if you have badly misadjusted the colors and you want to quickly return to reasonable settings. When the reset command is used, it will return the camera to the settings defined by your current Light Source Selector parameter setting.

You can execute the Color Adjustment Reset command from within your application software by using the pylon API. The following code snippet illustrates using the API to execute the command:

```
// Reset the color adjustments
Camera.ColorAdjustmentReset.Execute( );
```

You can also use the Basler pylon Viewer application to easily execute the command.

For more information about the pylon API and the pylon Viewer, see Section 3 on [page 21](#).

## 8.3.5 A Procedure for Setting the Color Enhancements

When setting the color enhancements on the camera, we recommend using the procedure outlined below. Since it makes changing camera parameters quick and easy, we also recommend using the Basler pylon Viewer software when you are making adjustments.

1. Arrange your camera so that it is viewing a scene similar to what it will view during actual operation. Make sure that the lighting for the scene is as close as possible to the actual lighting you will be using during normal operation. (Using lighting that represents your normal operating conditions is extremely important.)
2. We recommend including a standard color chart within your camera's field of view when you are adjusting the color enhancements. This will make it much easier to know when the colors are properly adjusted. One widely used chart is the ColorChecker® chart (also known as the Macbeth chart).
3. To start, leave the Light Source Selector parameter at the default setting.
4. Begin capturing images and check the basic image appearance. Set the exposure time and gain so that you are acquiring good quality images. It is important to make sure that the images are not over exposed. Over exposure can have a significant negative effect on the fidelity of the color in the acquired images.
5. Adjust the white balance. An easy way to set the white balance is to use the "once" function on the camera's balance white auto feature.
6. Set the gamma value. You should set the value to match the gamma on the monitor you are using to view acquired images. When gamma is set correctly, there should be a smooth transition from the lightest to the darkest gray scale targets on your color chart.  
(The sRGB gamma preset will give you good results on most CRT or LCD monitors.)
7. Examine the colors and see, if they are satisfactory at this point. If not, chose a different setting for the Light Source Selector parameter. Try each mode and determine which one gives you the best color results.
8. The color fidelity should now be quite good. If you want to make additional changes, adjust the hue and saturation by using the color adjustment feature. Keep in mind that when you adjust a color, the colors on each side of it in the color hexagon will also be affected to some degree. For example, when you adjust red, yellow and magenta will also be affected.

When you are making hue and saturation adjustments, it is a good idea to start by concentrating on one line in the color chart. Once you have the colors in a line properly adjusted, you can move on to each of the other lines in turn.



When you first start working with the color enhancement tools, it is easy to badly misadjust the color adjustment settings and not be able to bring them back into proper adjustment. You can easily recover from this situation by using the camera's color adjustment reset command (see [page 120](#)).

Another way to recover is to make the cameras "color factory setup" the default configuration set and then to load the default configuration set into the camera's active set. See the next section for more information about the camera's color factory setup.

## 8.3.6 The "Color" Factory Setup

When a camera leaves the factory, it contains several "factory setups" stored in its permanent memory. A factory setup is simply a collection of settings for the parameters needed to operate the camera. Each one of the factory setups is optimized to make the camera perform well in a particular situation. One of the setups is known as the "color factory setup", and the parameter settings contained in the color factory setup are optimized to produce good color images under the most common lighting conditions.

To make the parameters contained in the color factory setup become the ones that are actively controlling camera operation, you must select the color factory setup as the default camera configuration set and then you must load the default configuration set into the camera's active configuration set. When you do this, it will:

- Set the Gamma Selector parameter to sRGB
- Set the Processed Raw Enable parameter to enabled.
- Set the Light Source Selector parameter to Daylight 6500.
- Set the white balance parameters to values that are suitable for daylight lighting.

If you have badly misadjusted the settings for the color enhancement features on the camera, it may be difficult to bring the settings back into proper adjustment. Selecting the color factory setup as the default set and then loading the default set into the active set is a good way to recover from gross misadjustment of the color features.

For more information about the factory setups and about selecting and loading configuration sets, see Section 10.19 on [page 247](#).

# 9 Pixel Formats

By selecting a pixel format, you determine the format (layout) of the image data transmitted by the camera. This section provides detailed information about the available pixel formats.

## 9.1 Setting the Pixel Format

The setting for the camera's Pixel Format parameter determines the format of the pixel data that will be output from the camera. The available pixel formats depend on the camera model and whether the camera is monochrome or color. Table 7 lists the pixel formats available on each monochrome camera model and Table 8 lists the pixel formats available on each color camera model.

Mono Camera Model	Mono 8	Mono 12	Mono 12 Packed	YUV 4:2:2 Packed	YUV 4:2:2 (YUYV) Packed
avA1000-100gm	•	•	•	•	•
avA1600-50gm	•	•	•	•	•
avA1900-50gm	•	•	•	•	•
avA2300-25gm	•	•	•	•	•

Table 7: Pixel Formats Available on Monochrome Cameras (• = format available)

Color Camera Model	Mono 8	Bayer GB 8	Bayer GB 12	Bayer GB 12 Packed	YUV 4:2:2 Packed	YUV 4:2:2 (YUYV) Packed
avA1000-100gc	•	•	•	•	•	•
avA1600-50gc	•	•	•	•	•	•
avA1900-50gc	•	•	•	•	•	•
avA2300-25gc	•	•	•	•	•	•

Table 8: Pixel Formats Available on Color Cameras (• = format available)

Details of the monochrome formats are described in Section 9.2 on [page 125](#) and details of the color formats are described in Section 9.3 on [page 131](#).

You can set the Pixel Format parameter value from within your application software by using the Basler pylon API. The following code snippet illustrates using the API to set the parameter value:

```
Camera.PixelFormat.SetValue( PixelFormat_Mono8 );
Camera.PixelFormat.SetValue( PixelFormat_Mono12Packed );
Camera.PixelFormat.SetValue( PixelFormat_Mono12 );
Camera.PixelFormat.SetValue( PixelFormat_YUV422Packed );
Camera.PixelFormat.SetValue( PixelFormat_YUV422_YUYV_Packed );
Camera.PixelFormat.SetValue( PixelFormat_BayerGB8 );
Camera.PixelFormat.SetValue( PixelFormat_BayerGB12 );
Camera.PixelFormat.SetValue( PixelFormat_BayerGB12_Packed );
```

You can also use the Basler pylon Viewer application to easily set the parameters.

For more information about the pylon API and the pylon Viewer, see Section 3 on [page 21](#).

## 9.2 Pixel Formats for Mono Cameras

### 9.2.1 Mono 8 Format

When a monochrome camera is set for the Mono 8 pixel format, it outputs 8 bits of brightness data per pixel.

The table below describes how the pixel data for a received frame will be ordered in the image buffer in your PC when the camera is set for Mono8 output.

The following standards are used in the table:

$P_0$  = the first pixel transmitted by the camera

$P_n$  = the last pixel transmitted by the camera

$B_0$  = the first byte in the buffer

$B_m$  = the last byte in the buffer

Byte	Data
$B_0$	Brightness value for $P_0$
$B_1$	Brightness value for $P_1$
$B_2$	Brightness value for $P_2$
$B_3$	Brightness value for $P_3$
$B_4$	Brightness value for $P_4$
•	•
•	•

Byte	Data
•	•
•	•
$B_{m-4}$	Brightness value for $P_{n-4}$
$B_{m-3}$	Brightness value for $P_{n-3}$
$B_{m-2}$	Brightness value for $P_{n-2}$
$B_{m-1}$	Brightness value for $P_{n-1}$
$B_m$	Brightness value for $P_n$

With the camera set for Mono8, the pixel data output is 8 bit data of the “unsigned char” type. The available range of data values and the corresponding indicated signal levels are as shown in the table below.

This Data Value (Hexadecimal)	Indicates This Signal Level (Decimal)
0xFF	255
0xFE	254
•	•
•	•
•	•
0x01	1
0x00	0

## 9.2.2 Mono 12 Format

When a monochrome camera is set for the Mono12 pixel format, it outputs 16 bits of brightness data per pixel with 12 bits effective. The 12 bits of effective pixel data fill from the least significant bit. The four unused most significant bits are filled with zeros.

The table below describes how the pixel data for a received frame will be ordered in the image buffer in your PC when the camera is set for Mono12 output. Note that the data is placed in the image buffer in **little endian format**.

The following standards are used in the table:

$P_0$  = the first pixel transmitted by the camera

$P_n$  = the last pixel transmitted by the camera

$B_0$  = the first byte in the buffer

$B_m$  = the last byte in the buffer

Byte	Data
$B_0$	Low byte of brightness value for $P_0$
$B_1$	High byte of brightness value for $P_0$
$B_2$	Low byte of brightness value for $P_1$
$B_3$	High byte of brightness value for $P_1$
$B_4$	Low byte of brightness value for $P_2$
$B_5$	High byte of brightness value for $P_2$
$B_6$	Low byte of brightness value for $P_3$
$B_7$	High byte of brightness value for $P_3$
$B_8$	Low byte of brightness value for $P_4$
$B_9$	High byte of brightness value for $P_4$
•	•
•	•
•	•
$B_{m-7}$	Low byte of brightness value for $P_{n-3}$
$B_{m-6}$	High byte of brightness value for $P_{n-3}$
$B_{m-5}$	Low byte of brightness value for $P_{n-2}$
$B_{m-4}$	High byte of brightness value for $P_{n-2}$
$B_{m-3}$	Low byte of brightness value for $P_{n-1}$
$B_{m-2}$	High byte of brightness value for $P_{n-1}$
$B_{m-1}$	Low byte of brightness value for $P_n$
$B_m$	High byte of brightness value for $P_n$

When the camera is set for Mono 12, the pixel data output is 16 bit data of the “unsigned short (little endian)” type. The available range of data values and the corresponding indicated signal levels are as shown in the table below. Note that for 16 bit data, you might expect a value range from 0x0000 to 0xFFFF. However, with the camera set for Mono12 only 12 bits of the 16 bits transmitted are effective. Therefore, the highest data value you will see is 0x0FFF indicating a signal level of 4095.

<b>This Data Value (Hexadecimal)</b>	<b>Indicates This Signal Level (Decimal)</b>
0x0FFF	4095
0x0FFE	4094
•	•
•	•
•	•
0x0001	1
0x0000	0



## 9.2.3 Mono 12 Packed Format

When a monochrome camera is set for the Mono 12 Packed pixel format, it outputs 12 bits of brightness data per pixel. Every three bytes transmitted by the camera contain data for two pixels.

The table below describes how the pixel data for a received frame will be ordered in the image buffer in your PC when the camera is set for Mono 12 Packed output.

The following standards are used in the table:

$P_0$  = the first pixel transmitted by the camera

$P_n$  = the last pixel transmitted by the camera

$B_0$  = the first byte in the buffer

$B_m$  = the last byte in the buffer

Byte	Data	
$B_0$	$P_0$ bits 11 ... 4	
$B_1$	$P_1$ bits 3 ... 0	$P_0$ bits 3 ... 0
$B_2$	$P_1$ bits 11 ... 4	
$B_3$	$P_2$ bits 11 ... 4	
$B_4$	$P_3$ bits 3 ... 0	$P_2$ bits 3 ... 0
$B_5$	$P_3$ bits 11 ... 4	
$B_6$	$P_4$ bits 11 ... 4	
$B_7$	$P_5$ bits 3 ... 0	$P_4$ bits 3 ... 0
$B_8$	$P_5$ bits 11 ... 4	
$B_9$	$P_6$ bits 11 ... 4	
$B_{10}$	$P_7$ bits 3 ... 0	$P_6$ bits 3 ... 0
$B_{11}$	$P_7$ bits 11 ... 4	
•	•	
•	•	•
•	•	
$B_{m-5}$	$P_{n-3}$ bits 11 ... 4	
$B_{m-4}$	$P_{n-2}$ bits 3 ... 0	$P_{n-3}$ bits 3 ... 0
$B_{m-3}$	$P_{n-2}$ bits 11 ... 4	
$B_{m-2}$	$P_{n-1}$ bits 11 ... 4	
$B_{m-1}$	$P_n$ bits 3 ... 0	$P_{n-1}$ bits 3 ... 0
$B_m$	$P_n$ bits 11 ... 4	

When a monochrome camera is set for Mono 12 Packed, the pixel data output is 12 bit data of the “unsigned” type. The available range of data values and the corresponding indicated signal levels are as shown in the table below.

<b>This Data Value (Hexadecimal)</b>	<b>Indicates This Signal Level (Decimal)</b>
0x0FFF	4095
0x0FFE	4094
•	•
•	•
•	•
0x0001	1
0x0000	0

## 9.2.4 YUV 4:2:2 Packed Format

When a monochrome camera is set for the YUV 4:2:2 Packed pixel format, the camera transmits Y, U, and V values in a fashion that mimics the output from a color camera set for YUV 4:2:2 Packed.

The Y value transmitted for each pixel is an actual 8 bit brightness value similar to the pixel data transmitted when a monochrome camera is set for Mono 8. The U and V values transmitted will always be zero. With this color coding, a Y value is transmitted for each pixel, but the U and V values are only transmitted for every second pixel.

The order of the pixel data for a received frame in the image buffer in your PC is similar to the order of YUV 4:2:2 Packed output from a color camera.

For more information about the YUV 4:2:2 Packed format on color cameras, see Section 9.3.4 on [page 137](#).

## 9.2.5 YUV 4:2:2 (YUYV) Packed Format

When a monochrome camera is set for the YUV 4:2:2 (YUYV) Packed pixel format, the camera transmits Y, U, and V values in a fashion that mimics the output from a color camera set for YUV 4:2:2 (YUYV) Packed.

The Y value transmitted for each pixel is an actual 8 bit brightness value similar to the pixel data transmitted when a monochrome camera is set for Mono 8. The U and V values transmitted will always be zero. With this color coding, a Y value is transmitted for each pixel, but the U and V values are only transmitted for every second pixel.

The order of the pixel data for a received frame in the image buffer in your PC is similar to the order of YUV 4:2:2 (YUYV) Packed output from a color camera.

For more information about the YUV 4:2:2 (YUYV) Packed format on color cameras, see Section 9.3.5 on [page 139](#).

## 9.3 Pixel Data Output Formats for Color Cameras

### 9.3.1 Bayer GB 8 Format

When a color camera is set for the Bayer GB 8 pixel format, it outputs 8 bits of data per pixel and the pixel data is not processed or interpolated in any way. So, for each pixel covered with a red lens, you get 8 bits of red data. For each pixel covered with a green lens, you get 8 bits of green data. And for each pixel covered with a blue lens, you get 8 bits of blue data. (This type of pixel data is sometimes referred to as "raw" output.)

The "GB" in the name Bayer GB 8 refers to the alignment of the colors in the Bayer filter to the pixels in the acquired images. For even lines in the images, pixel zero will be green, pixel one will be blue, pixel two will be green, pixel three will be blue, etc. For odd lines in the images, pixel zero will be red, pixel one will be green, pixel two will be red, pixel three will be green, etc.

For more information about the Bayer filter, see Section 8.1 on [page 104](#).

The tables below describe how the data for the even lines and for the odd lines of a received frame will be ordered in the image buffer in your PC when the camera is set for Bayer GB 8 output.

The following standards are used in the tables:

$P_0$  = the first pixel transmitted by the camera for a line

$P_n$  = the last pixel transmitted by the camera for a line

$B_0$  = the first byte of data for a line

$B_m$  = the last byte of data for a line

Even Lines	
Byte	Data
$B_0$	Green value for $P_0$
$B_1$	Blue value for $P_1$
$B_2$	Green value for $P_2$
$B_3$	Blue value for $P_3$
$B_4$	Green value for $P_4$
$B_5$	Blue value for $P_5$
•	•
•	•
•	•
$B_{m-5}$	Green value for $P_{n-5}$
$B_{m-4}$	Blue value for $P_{n-4}$

Odd Lines	
Byte	Data
$B_0$	Red value for $P_0$
$B_1$	Green value for $P_1$
$B_2$	Red value for $P_2$
$B_3$	Green value for $P_3$
$B_4$	Red value for $P_4$
$B_5$	Green value for $P_5$
•	•
•	•
•	•
$B_{m-5}$	Red value for $P_{n-5}$
$B_{m-4}$	Green value for $P_{n-4}$

$B_{m-3}$	Green value for $P_{n-3}$
$B_{m-2}$	Blue value for $P_{n-2}$
$B_{m-1}$	Green value for $P_{n-1}$
$B_m$	Blue value for $P_n$

$B_{m-3}$	Red value for $P_{n-3}$
$B_{m-2}$	Green value for $P_{n-2}$
$B_{m-1}$	Red value for $P_{n-1}$
$B_m$	Green value for $P_n$

With the camera set for Bayer GB 8, the pixel data output is 8 bit data of the “unsigned char” type. The available range of data values and the corresponding indicated signal levels are as shown in the table below.

This Data Value (Hexadecimal)	Indicates This Signal Level (Decimal)
0xFF	255
0xFE	254
•	•
•	•
•	•
0x01	1
0x00	0

## 9.3.2 Bayer GB 12 Format

When a color camera is set for the Bayer GB 12 pixel format, it outputs 16 bits of data per pixel with 12 bits effective. The 12 bits of effective pixel data fill from the least significant bit. The four unused most significant bits are filled with zeros.

With the Bayer GB 12 the pixel data is not processed or interpolated in any way. So, for each pixel covered with a red lens, you get 12 effective bits of red data. For each pixel covered with a green lens, you get 12 effective bits of green data. And for each pixel covered with a blue lens, you get 12 effective bits of blue data. (This type of pixel data is sometimes referred to as "raw" output.)

The "GB" in the name Bayer GB 12 refers to the alignment of the colors in the Bayer filter to the pixels in the acquired images. For even rows in the images, pixel one will be green, pixel two will be blue, pixel three will be green, pixel four will be blue, etc. For odd rows in the images, pixel one will be red, pixel two will be green, pixel three will be red, pixel four will be green, etc.

For more information about the Bayer filter, see Section 8.1 on [page 104](#).

The tables below describe how the data for the even rows and for the odd rows of a received frame will be ordered in the image buffer in your PC when the camera is set for Bayer GB12 output. Note that the data is placed in the image buffer in **little endian format**.

The following standards are used in the tables:

$P_0$  = the first pixel transmitted by the camera for a row

$P_n$  = the last pixel transmitted by the camera for a row

$B_0$  = the first byte of data for a row

$B_m$  = the last byte of data for a row

Even Rows	
Byte	Data
$B_0$	Low byte of green value for $P_0$
$B_1$	High byte of green value for $P_0$
$B_2$	Low byte of blue value for $P_1$
$B_3$	High byte of blue value for $P_1$
$B_4$	Low byte of green value for $P_2$
$B_5$	High byte of green value for $P_2$
$B_6$	Low byte of blue value for $P_3$
$B_7$	High byte of blue value for $P_3$
•	•
•	•
•	•
$B_{m-7}$	Low byte of green value for $P_{n-3}$
$B_{m-6}$	High byte of green value for $P_{n-3}$

Odd Rows	
Byte	Data
$B_0$	Low byte of red value for $P_0$
$B_1$	High byte of red value for $P_0$
$B_2$	Low byte of green value for $P_1$
$B_3$	High byte of green value for $P_1$
$B_4$	Low byte of red value for $P_2$
$B_5$	High byte of red value for $P_2$
$B_6$	Low byte of green value for $P_3$
$B_7$	High byte of green value for $P_3$
•	•
•	•
•	•
$B_{m-7}$	Low byte of red value for $P_{n-3}$
$B_{m-6}$	High byte of red value for $P_{n-3}$

B <sub>m-5</sub>	Low byte of blue value for P <sub>n-2</sub>
B <sub>m-4</sub>	High byte of blue value for P <sub>n-2</sub>
B <sub>m-3</sub>	Low byte of green value for P <sub>n-1</sub>
B <sub>m-2</sub>	High byte of green value for P <sub>n-1</sub>
B <sub>m-1</sub>	Low byte of blue value for P <sub>n</sub>
B <sub>m</sub>	High byte of blue value for P <sub>n</sub>

B <sub>m-5</sub>	Low byte of green value for P <sub>n-2</sub>
B <sub>m-4</sub>	High byte of green value for P <sub>n-2</sub>
B <sub>m-3</sub>	Low byte of red value for P <sub>n-1</sub>
B <sub>m-2</sub>	High byte of red value for P <sub>n-1</sub>
B <sub>m-1</sub>	Low byte of green value for P <sub>n</sub>
B <sub>m</sub>	High byte of green value for P <sub>n</sub>

When the camera is set for Bayer GB 12, the pixel data output is 16 bit data of the “unsigned short (little endian)” type. The available range of data values and the corresponding indicated signal levels are as shown in the table below. Note that for 16 bit data, you might expect a value range from 0x0000 to 0xFFFF. However, with the camera set for Bayer GB 12 only 12 bits of the 16 bits transmitted are effective. Therefore, the highest data value you will see is 0x0FFF indicating a signal level of 4095.

This Data Value (Hexadecimal)	Indicates This Signal Level (Decimal)
0x0FFF	4095
0x0FFE	4094
•	•
•	•
•	•
0x0001	1
0x0000	0

### 9.3.3 Bayer GB 12 Packed Format

When a color camera is set for the Bayer GB 12 Packed pixel format, it outputs 12 bits of data per pixel. Every three bytes transmitted by the camera contain data for two pixels.

With the Bayer GB 12 Packed coding, the pixel data is not processed or interpolated in any way. So, for each pixel covered with a red lens in the sensor's Bayer filter, you get 12 bits of red data. For each pixel covered with a green lens in the filter, you get 12 bits of green data. And for each pixel covered with a blue lens in the filter, you get 12 bits of blue data. (This type of pixel data is sometimes referred to as "raw" output.)

For more information about the Bayer filter, see Section 8.1 on [page 104](#).

The tables below describe how the data for the even lines and for the odd lines of a received frame will be ordered in the image buffer in your PC when the camera is set for Bayer GB 12 Packed output.

The following standards are used in the tables:

$P_0$  = the first pixel transmitted by the camera for a line

$P_n$  = the last pixel transmitted by the camera for a line

$B_0$  = the first byte of data for a line

$B_m$  = the last byte of data for a line

Even Lines	
Byte	Data
$B_0$	Green value for $P_0$ bits 11 ... 4
$B_1$	Blue value for $P_1$ bits 3 ... 0      Green value for $P_0$ bits 3 ... 0
$B_2$	Blue value for $P_1$ bits 11 ... 4
$B_3$	Green value for $P_2$ bits 11 ... 4
$B_4$	Blue value for $P_3$ bits 3 ... 0      Green value for $P_2$ bits 3 ... 0
$B_5$	Blue value for $P_3$ bits 11 ... 4
$B_6$	Green value for $P_4$ bits 11 ... 4
$B_7$	Blue value for $P_5$ bits 3 ... 0      Green value for $P_4$ bits 3 ... 0
$B_8$	Blue value for $P_5$ bits 11 ... 4
•	•
•	•      •
•	•
$B_{m-5}$	Green value for $P_{n-3}$ bits 11 ... 4
$B_{m-4}$	Blue value for $P_{n-2}$ bits 3 ... 0      Green value for $P_{n-3}$ bits 3 ... 0
$B_{m-3}$	Blue value for $P_{n-2}$ bits 11 ... 4
$B_{m-2}$	Green value for $P_{n-1}$ bits 11 ... 4
$B_{m-1}$	Blue value for $P_n$ bits 3 ... 0      Green value for $P_{n-1}$ bits 3 ... 0
$B_m$	Blue value for $P_n$ bits 11 ... 4



Odd Lines	
Byte	Data
B <sub>0</sub>	Red value for P <sub>0</sub> bits 11 ... 4
B <sub>1</sub>	Green value for P <sub>1</sub> bits 3 ... 0      Red value for P <sub>0</sub> bits 3 ... 0
B <sub>2</sub>	Green value for P <sub>1</sub> bits 11 ... 4
B <sub>3</sub>	Red value for P <sub>2</sub> bits 11 ... 4
B <sub>4</sub>	Green value for P <sub>3</sub> bits 3 ... 0      Red value for P <sub>2</sub> bits 3 ... 0
B <sub>5</sub>	Green value for P <sub>3</sub> bits 11 ... 4
B <sub>6</sub>	Red value for P <sub>4</sub> bits 11 ... 4
B <sub>7</sub>	Green value for P <sub>5</sub> bits 3 ... 0      Red value for P <sub>4</sub> bits 3 ... 0
B <sub>8</sub>	Green value for P <sub>5</sub> bits 11 ... 4
•	•
•	•      •
•	•
•	•
•	•      •
•	•
B <sub>m-5</sub>	Red value for P <sub>n-3</sub> bits 11 ... 4
B <sub>m-4</sub>	Green value for P <sub>n-2</sub> bits 3 ... 0      Red value for P <sub>n-3</sub> bits 3 ... 0
B <sub>m-3</sub>	Green value for P <sub>n-2</sub> bits 11 ... 4
B <sub>m-2</sub>	Red value for P <sub>n-1</sub> bits 11 ... 4
B <sub>m-1</sub>	Green value for P <sub>n</sub> bits 3 ... 0      Red value for P <sub>n-1</sub> bits 3 ... 0
B <sub>m</sub>	Green value for P <sub>n</sub> bits 11 ... 4

When a color camera is set for Bayer GB 12 Packed, the pixel data output is 12 bit data of the “unsigned” type. The available range of data values and the corresponding indicated signal levels are as shown in the table below.

This Data Value (Hexadecimal)	Indicates This Signal Level (Decimal)
0x0FFF	4095
0x0FFE	4094
•	•
•	•
•	•
0x0001	1
0x0000	0

## 9.3.4 YUV 4:2:2 Packed Format

When a color camera is set for the YUV 422 Packed pixel format, each pixel value in the captured image goes through a conversion process as it exits the sensor and passes through the camera's electronics. This process yields Y, U, and V color information for each pixel value.

For more information about the conversion processes, see Section 8.1.2 on [page 105](#).



The values for U and for V normally range from -128 to +127. Because the camera transfers U values and V values with unsigned integers, 128 is added to each U value and to each V value before the values are transferred from the camera. This process allows the values to be transferred on a scale that ranges from 0 to 255.

The table below describes how the pixel data for a received frame will be ordered in the image buffer in your PC when the camera is set for YUV 4:2:2 Packed output.

The following standards are used in the table:

$P_0$  = the first pixel transmitted by the camera

$P_n$  = the last pixel transmitted by the camera

$B_0$  = the first byte in the buffer

$B_m$  = the last byte in the buffer

Byte	Data
$B_0$	U value for $P_0$
$B_1$	Y value for $P_0$
$B_2$	V Value for $P_0$
$B_3$	Y value for $P_1$
$B_4$	U value for $P_2$
$B_5$	Y value for $P_2$
$B_6$	V Value for $P_2$
$B_7$	Y value for $P_3$
$B_8$	U value for $P_4$
$B_9$	Y value for $P_4$
$B_{10}$	V Value for $P_4$
$B_{11}$	Y value for $P_5$
•	•
•	•
•	•
$B_{m-7}$	U value for $P_{n-3}$
$B_{m-6}$	Y value for $P_{n-3}$
$B_{m-5}$	V Value for $P_{n-3}$

B <sub>m-4</sub>	Y value for P <sub>n-2</sub>
B <sub>m-3</sub>	U value for P <sub>n-1</sub>
B <sub>m-2</sub>	Y value for P <sub>n-1</sub>
B <sub>m-1</sub>	V Value for P <sub>n-1</sub>
B <sub>m</sub>	Y value for P <sub>n</sub>

When the camera is set for YUV 4:2:2 Packed output, the pixel data output for the Y component is 8 bit data of the “unsigned char” type. The range of data values for the Y component and the corresponding indicated signal levels are shown below.

This Data Value (Hexadecimal)	Indicates This Signal Level (Decimal)
0xFF	255
0xFE	254
•	•
•	•
•	•
0x01	1
0x00	0

The pixel data output for the U component or the V component is 8 bit data of the “straight binary” type. The range of data values for a U or a V component and the corresponding indicated signal levels are shown below.

This Data Value (Hexadecimal)	Indicates This Signal Level (Decimal)
0xFF	127
0xFE	126
•	•
•	•
•	•
0x81	1
0x80	0
0x7F	-1
•	•
•	•
•	•
0x01	-127
0x00	-128

The signal level of a U component or a V component can range from -128 to +127 (decimal). Notice that the data values have been arranged to represent the full signal level range.

### 9.3.5 YUV 4:2:2 (YUYV) Packed Format

On color cameras, the YUV 4:2:2 (YUYV) packed pixel format is similar to the YUV 4:2:2 pixel format described in the previous section. The only difference is the order of the bytes transmitted to the host PC. With the YUV 4:2:2 format, the bytes are ordered as specified in the DCAM standard issued by the 1394 Trade Association. With the YUV 4:2:2 (YUYV) format, the bytes are ordered to emulate the ordering normally associated with analog frame grabbers and Windows<sup>®</sup> frame buffers.

The table below describes how the pixel data for a received frame will be ordered in the image buffer in your PC when the camera is set for YUV 4:2:2 (YUYV) output.

With this format, the Y component is transmitted for each pixel, but the U and V components are only transmitted for every second pixel.

The following standards are used in the table:

$P_0$  = the first pixel transmitted by the camera

$P_n$  = the last pixel transmitted by the camera

$B_0$  = the first byte in the buffer

$B_m$  = the last byte in the buffer

Byte	Data
$B_0$	Y value for $P_0$
$B_1$	U value for $P_0$
$B_2$	Y value for $P_1$
$B_3$	V value for $P_0$
$B_4$	Y value for $P_2$
$B_5$	U value for $P_2$
$B_6$	Y value for $P_3$
$B_7$	V value for $P_2$
$B_8$	Y value for $P_4$
$B_9$	U value for $P_4$
$B_{10}$	Y value for $P_5$
$B_{11}$	V value for $P_4$
•	•
•	•
•	•
$B_{m-7}$	Y value for $P_{n-3}$
$B_{m-6}$	U value for $P_{n-3}$
$B_{m-5}$	Y value for $P_{n-2}$
$B_{m-4}$	V value for $P_{n-3}$
$B_{m-3}$	Y value for $P_{n-1}$
$B_{m-2}$	U value for $P_{n-1}$
$B_{m-1}$	Y value for $P_n$
$B_m$	V value for $P_{n-1}$

When a color camera is set for YUV 4:2:2 (YUYV) output, the pixel data output for the Y component is 8 bit data of the “unsigned char” type. The range of data values for the Y component and the corresponding indicated signal levels are shown below.

<b>This Data Value (Hexadecimal)</b>	<b>Indicates This Signal Level (Decimal)</b>
0xFF	255
0xFE	254
•	•
•	•
•	•
0x01	1
0x00	0

The pixel data output for the U component or the V component is 8 bit data of the “straight binary” type. The range of data values for a U or a V component and the corresponding indicated signal levels are shown below.

<b>This Data Value (Hexadecimal)</b>	<b>Indicates This Signal Level (Decimal)</b>
0xFF	127
0xFE	126
•	•
•	•
•	•
0x81	1
0x80	0
0x7F	-1
•	•
•	•
•	•
0x01	-127
0x00	-128

The signal level of a U component or a V component can range from -128 to +127 (decimal). Notice that the data values have been arranged to represent the full signal level range.

## 9.3.6 Mono 8 Format

When a color camera is set for the Mono 8 pixel format, the values for each pixel are first converted to the YUV color model. The camera then transmits the 8 bit Y value for each pixel to the host PC. In the YUV color model, the Y component for each pixel represents a brightness value. This brightness value can be considered as equivalent to the value that would be sent from a pixel in a monochrome camera. In the color camera, however, the Y component is derived from brightness values of the pixel and neighboring pixels. So in essence, when a color camera is set for Mono 8, it outputs an 8 bit monochrome image. (This type of output is sometimes referred to as "Y Mono 8".)

The table below describes how the pixel data for a received frame will be ordered in the image buffer in your PC when a color camera is set for Mono 8 output.

The following standards are used in the table:

$P_0$  = the first pixel transmitted by the camera

$P_n$  = the last pixel transmitted by the camera

$B_0$  = the first byte in the buffer

$B_m$  = the last byte in the buffer

Byte	Data
$B_0$	Y value for $P_0$
$B_1$	Y value for $P_1$
$B_2$	Y value for $P_2$
$B_3$	Y value for $P_3$
$B_4$	Y value for $P_4$
$B_5$	Y value for $P_5$
$B_6$	Y value for $P_6$
$B_7$	Y value for $P_7$
•	•
•	•
•	•
$B_{m-3}$	Y value for $P_{n-3}$
$B_{m-2}$	Y value for $P_{n-2}$
$B_{m-1}$	Y value for $P_{n-1}$
$B_m$	Y value for $P_n$

With the camera set for Mono 8, the pixel data output is 8 bit data of the “unsigned char” type. The available range of data values and the corresponding indicated signal levels are as shown in the table below.

<b>This Data Value (Hexadecimal)</b>	<b>Indicates This Signal Level (Decimal)</b>
0xFF	255
0xFE	254
•	•
•	•
•	•
0x01	1
0x00	0

## 9.4 Pixel Transmission Sequence

For each captured image, pixel data is transmitted from the camera in the following sequence:

Row <sub>0</sub> Col <sub>0</sub> ,	Row <sub>0</sub> Col <sub>1</sub> ,	Row <sub>0</sub> Col <sub>2</sub>	.. ..	Row <sub>0</sub> Col <sub>m-2</sub> ,	Row <sub>0</sub> Col <sub>m-1</sub> ,	Row <sub>0</sub> Col <sub>m</sub>
Row <sub>1</sub> Col <sub>0</sub> ,	Row <sub>1</sub> Col <sub>1</sub> ,	Row <sub>1</sub> Col <sub>2</sub>	.. ..	Row <sub>1</sub> Col <sub>m-2</sub> ,	Row <sub>1</sub> Col <sub>m-1</sub> ,	Row <sub>1</sub> Col <sub>m</sub>
Row <sub>2</sub> Col <sub>0</sub> ,	Row <sub>2</sub> Col <sub>1</sub> ,	Row <sub>2</sub> Col <sub>2</sub>	.. ..	Row <sub>2</sub> Col <sub>m-2</sub> ,	Row <sub>2</sub> Col <sub>m-1</sub> ,	Row <sub>2</sub> Col <sub>m</sub>
:	:	:		:	:	:
:	:	:		:	:	:
Row <sub>n-2</sub> Col <sub>0</sub> ,	Row <sub>n-2</sub> Col <sub>1</sub> ,	Row <sub>n-2</sub> Col <sub>2</sub>	.. ..	Row <sub>n-2</sub> Col <sub>m-2</sub> ,	Row <sub>n-2</sub> Col <sub>m-1</sub> ,	Row <sub>n-2</sub> Col <sub>m</sub>
Row <sub>n-1</sub> Col <sub>0</sub> ,	Row <sub>n-1</sub> Col <sub>1</sub> ,	Row <sub>n-1</sub> Col <sub>2</sub>	.. ..	Row <sub>n-1</sub> Col <sub>m-2</sub> ,	Row <sub>n-1</sub> Col <sub>m-1</sub> ,	Row <sub>n-1</sub> Col <sub>m</sub>
Row <sub>n</sub> Col <sub>0</sub> ,	Row <sub>n</sub> Col <sub>1</sub> ,	Row <sub>n</sub> Col <sub>2</sub>	.. ..	Row <sub>n</sub> Col <sub>m-2</sub> ,	Row <sub>n</sub> Col <sub>m-1</sub> ,	Row <sub>n</sub> Col <sub>m</sub>

Where Row<sub>0</sub> Col<sub>0</sub> is the upper left corner of the sensor

The columns are numbered 0 through m from the left side to the right side of the sensor

The rows are numbered 0 through n from the top to the bottom of the sensor

The sequence assumes that the camera is set for full resolution.



# 10 Standard Features

This chapter provides detailed information about the standard features available on each camera. It also includes an explanation of their operation and the parameters associated with each feature.

## 10.1 Sensor Digitization Taps

The camera can be set to four tap or to one tap sensor digitization.

- With **four tap digitization**, **four separate electronic circuits** (taps) are used to read out pixel values from the sensor after a frame has been exposed. The main advantage of four tap mode is that it reads out the sensor very rapidly and can result in higher maximum allowed frame acquisition rates.
- With **one tap digitization**, a **single electronic circuit** (tap) is used to read out pixel values from the sensor after a frame has been exposed. The main advantage of one tap mode is that it can produce a more uniform image. A disadvantage is that in single tap mode, the maximum allowed frame acquisition rate will be significantly reduced.

For more information about sensor digitization taps, see Section 4.1 on [page 23](#).

### Setting the Sensor Digitization Taps

You can use the pylon API to set the sensor digitization taps from within your application software. The following code snippet illustrates using the API to set the exposure mode:

```
// Set the digitization taps to 4
Camera.SensorDigitizationTaps.SetValue( SensorDigitizationTaps_Four );

// Set the digitization taps to 1
Camera.SensorDigitizationTaps.SetValue( SensorDigitizationTaps_One );
```

You can also use the Basler pylon Viewer application to easily set the parameters.

For more information about the pylon API and the pylon Viewer, see Section 3 on [page 21](#).

## 10.2 Gain



This section (Section 10.2) describes the basic theory of gain and how gain can be adjusted "manually", i.e., by setting the value of the individual gain related parameters.

The camera also has a Gain Auto function that can automatically adjust the gain. **Manual adjustment of the gain parameters will only work correctly if the Gain Auto function is disabled.**

For more information about

- auto functions in general, see Section 10.7 on [page 164](#).
- the Gain Auto function in particular, see Section 10.7.5 on [page 173](#).

Note that on cameras delivered from the factory, all auto functions will become disabled whenever you power on or reset the camera.

To change this behavior, you must change the configuration set settings. For more information about configuration sets, see Section 10.19 on [page 247](#).

The camera's gain setting is adjustable. As shown in Figure 39, increasing the gain increases the slope of the response curve for the camera. This results in a higher gray value output from the camera for a given amount of output from the imaging sensor. Decreasing the gain decreases the slope of the response curve and results in a lower gray value for a given amount of sensor output.

Increasing the gain is useful when at your brightest exposure, a gray value lower than 255 (in modes that output 8 bits per pixel) or 4095 (in modes that output 12 bits per pixels) is reached. For example, if you found that at your brightest exposure the gray values output by the camera were no higher than 127 (in an 8 bit mode), you could increase the gain to 6 dB (an amplification factor of 2) and thus reach gray values of 254.

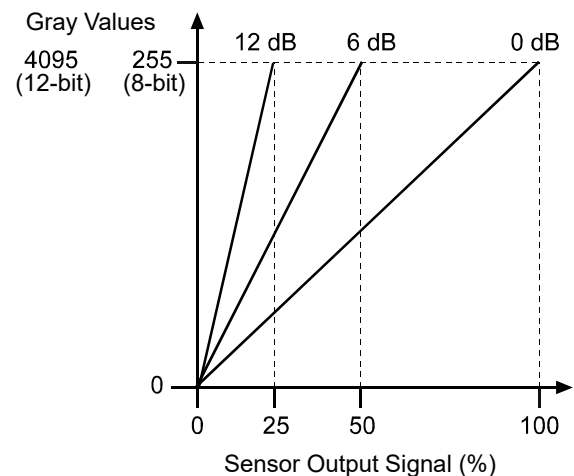

Fig. 39: Gain in dB

## 10.2.1 Gain with Four Tap Sensor Digitization

As mentioned in the "Functional Description" section of this manual, when the camera is set for four tap sensor digitization, the imaging sensor is divided into four quadrants for readout purposes. Each quadrant is read out by a separate tap (electronic circuit). As a result of this design, there are five gain parameters available: Gain All, Gain Tap 1, and Gain Tap 2, Gain Tap 3, and Gain Tap 4.

**Gain All** is a global adjustment, i.e., its setting affects all four quadrants of the sensor.

**Gain Tap 1** sets an additional amount of gain for the top left quadrant of the sensor. The total gain for the top left quadrant will be the sum of the Gain All value plus the Gain Tap 1 value.

**Gain Tap 2** sets an additional amount of gain for the top right quadrant of the sensor. The total gain for the top right quadrant will be the sum of the Gain All value plus the Gain Tap 2 value.

**Gain Tap 3** sets an additional amount of gain for the bottom left quadrant of the sensor. The total gain for the bottom left quadrant will be the sum of the Gain All value plus the Gain Tap 3 value.

**Gain Tap 4** sets an additional amount of gain for the bottom right quadrant of the sensor. The total gain for the bottom right quadrant will be the sum of the Gain All value plus the Gain Tap 4 value.

The settings for the gain parameters must adhere to the following limits:

- The Gain All parameter value can be set in a range from 0 to 600.
- The Gain Tap 1, Gain Tap 2, Gain Tap 3, or Gain Tap 4 parameters values can each be set in a range from 0 to 600.
- The sum of the Gain All setting plus the Gain Tap 1 setting must be between 0 and 600 (inclusive).
- The sum of the Gain All setting plus the Gain Tap 2 setting must be between 0 and 600 (inclusive).
- The sum of the Gain All setting plus the Gain Tap 3 setting must be between 0 and 600 (inclusive).
- The sum of the Gain All setting plus the Gain Tap 4 setting must be between 0 and 600 (inclusive).



For normal operation, we strongly recommend that you set the value of all four tap gains to the minimum and that you simply use Gain All to set the gain. Typically, the tap gains are only used if you want to adjust the gain balance between the quadrants of the sensor.

If you know the current settings for Gain All, Gain Tap 1, Gain Tap 2, Gain Tap 3, and Gain Tap 4, you can use the formula below to calculate the dB of gain that will result on each tap:

$$\text{Gain on Tap N} = (0.0359 \times \text{Gain All Setting}) + (0.0359 \times \text{Gain Tap N Setting})$$

Where N is 1, 2, 3, or 4

For example, assume that you have set the Gain All to 450 and the tap 1 gain to 0. The gain on tap 1 would be:

$$\text{Gain on Tap 1} = (0.0359 \times 450) + (0.0359 \times 0) = 16.2 \text{ dB}$$

## Setting the Gain

When the camera is set to four tap digitization mode, setting the gain with Basler pylon is a several step process:

To set the Gain All parameter value:

- Set the Gain Selector to All.
- Set the Gain Raw parameter to your desired value.

To set the Gain Tap 1, Gain Tap 2, Gain Tap 3, or Gain Tap 4 parameter values:

- Set the Gain Selector to Tap 1, Tap 2, Tap 3, or Tap 4.
- Set the Gain Raw parameter to your desired value.

You can use the pylon API to set the Gain Selector and the Gain Raw parameter values from within your application software. The following code snippet illustrates using the API to set the selector and the parameter value:

```
// Set Gain All
Camera.GainSelector.SetValue( GainSelector_All );
Camera.GainRaw.SetValue( 450 );

// Set Gain Tap 1
Camera.GainSelector.SetValue( GainSelector_Tap1 );
Camera.GainRaw.SetValue( 0 );

// Set Gain Tap 2
Camera.GainSelector.SetValue( GainSelector_Tap2 );
Camera.GainRaw.SetValue( 0 );

// Set Gain Tap 3
Camera.GainSelector.SetValue( GainSelector_Tap3 );
Camera.GainRaw.SetValue( 0 );

// Set Gain Tap 4
Camera.GainSelector.SetValue( GainSelector_Tap4 );
Camera.GainRaw.SetValue( 0 );
```

You can also use the Basler pylon Viewer application to easily set the parameters.

For more information about the pylon API and the pylon Viewer, see Section 3 on [page 21](#).

## 10.2.2 Gain with One Tap Sensor Digitization

As mentioned in the "Camera Functional Description" section of this manual, when the camera is set for one tap sensor digitization, a single tap (electronic circuit) is used to read out the sensor. As a result of this design, there is one gain parameter available when the camera is set for one tap digitization: Gain All.

The minimum, maximum, and adjustment methods for this parameter are similar to those described in the previous section.

## 10.3 Black Level

### 10.3.1 Black Level with Four Tap Sensor Digitization

Adjusting the camera's black level will result in an offset to the pixel values output from the camera.

As mentioned in the "Functional Description" section of this manual, when the camera is set for four tap sensor digitization, the imaging sensor is divided into four quadrants for readout purposes. Each quadrant is read out by a separate tap (electronic circuit). As a result of this design, there are five black level parameters available: Black Level All, Black Level Tap 1, and Black Level Tap 2, Black Level Tap 3, and Black Level Tap 4.

**Black Level All** is a global adjustment, i.e., its setting affects all four quadrants of the sensor.

**Black Level Tap 1** sets an additional amount of black level for the top left quadrant of the sensor. The total black level for the top left quadrant will be the sum of the Black Level All value plus the Black Level Tap 1 value.

**Black Level Tap 2** sets an additional amount of black level for the top right quadrant of the sensor. The total black level for the top right quadrant will be the sum of the Black Level All value plus the Black Level Tap 2 value.

**Black Level Tap 3** sets an additional amount of black level for the bottom left quadrant of the sensor. The total black level for the bottom left quadrant will be the sum of the Black Level All value plus the Black Level Tap 3 value.

**Black Level Tap 4** sets an additional amount of black level for the bottom right quadrant of the sensor. The total black level for the bottom right quadrant will be the sum of the Black Level All value plus the Black Level Tap 4 value.

If the camera is set for

- **8 bit pixel depth**, an increase of 64 in a black level setting will result in a positive offset of 1 in the pixel values output from the camera. And a decrease of 64 in a black level setting result in a negative offset of 1 in the pixel values output from the camera.
- **12 bit pixel depth**, an increase of 4 in a black level setting will result in a positive offset of 1 in the pixel values output from the camera. A decrease of 4 in a black level setting will result in a negative offset of 1 in the pixel values output from the camera.

When adjusting the black levels, the following guidelines must be met:

- The sum of the Black Level All plus the Black Level Tap 1 parameter settings must be less than or equal to 950.
- The sum of the Black Level All plus the Black Level Tap 2 parameter settings must be less than or equal to 950.
- The sum of the Black Level All plus the Black Level Tap 3 parameter settings must be less than or equal to 950.
- The sum of the Black Level All plus the Black Level Tap 4 parameter settings must be less than or equal to 950.



For normal operation, we recommend that you set the value of the tap black levels to zero and that you simply use Black Level All to set the black level. Typically, the tap black level settings are only used if you want to adjust the black level balance between the quadrants of the sensor.

## Setting the Black Level

When the camera is set for four tap digitization mode, setting the black level with Basler pylon is a several step process:

To set the Black Level All parameter value:

- Set the Black Level Selector to All.
- Set the Black Level Raw parameter to your desired value.

To set the Black Level Tap 1, Black Level Tap 2, Black Level Tap 3, or Black Level Tap 4 parameter value:

- Set the Black Level Selector to Tap 1, Tap 2, Tap 3, or Tap 4.
- Set the Black Level Raw parameter to your desired value.

You can use the pylon API to set the Black Level Selector and the Black Level Raw parameter values from within your application software. The following code snippet illustrates using the API to set the selector and the parameter value:

```
// Set Black Level All
Camera.BlackLevelSelector.SetValue ( BlackLevelSelector_All );
Camera.BlackLevelRaw.SetValue( 64 );

// Set Black Level Raw Tap 1
Camera.BlackLevelSelector.SetValue ( BlackLevelSelector_Tap1 );
Camera.BlackLevelRaw.SetValue( 0 );

// Set Black Level Raw Tap 2
Camera.BlackLevelSelector.SetValue ( BlackLevelSelector_Tap2 );
Camera.BlackLevelRaw.SetValue( 0 );

// Set Black Level Raw Tap 3
Camera.BlackLevelSelector.SetValue ( BlackLevelSelector_Tap3 );
Camera.BlackLevelRaw.SetValue( 0 );

// Set Black Level Raw Tap 4
Camera.BlackLevelSelector.SetValue ( BlackLevelSelector_Tap4 );
Camera.BlackLevelRaw.SetValue( 0 );
```

You can also use the Basler pylon Viewer application to easily set the parameters.

For more information about the pylon API and the pylon Viewer, see Section 3 on [page 21](#).

## 10.3.2 Black Level with One Tap Sensor Digitization

As mentioned in the "Camera Functional Description" section of this manual, when the camera is set for one tap sensor digitization, a single tap (electronic circuit) is used to read out the sensor. As a result of this design, there is one black level parameter available when the camera is set for one tap digitization: Black Level All.

The minimums, maximums, and adjustment methods for this parameter are similar to those described in the previous section.



## 10.4 Remove Parameter Limits

For each camera parameter, the allowed range of parameter values is normally limited. A parameter that is outside the allowed parameter range is automatically set to, either the minimum or maximum value, depending on whether the entered value is below the minimum or above the maximum allowed value. The factory limits are designed to ensure optimum camera operation and, in particular, good image quality.

For special camera uses, however, it may be helpful to set parameter values outside of the factory limits.

The remove parameter limits feature lets you remove the factory parameter limits for certain parameters. When the factory parameter limits are removed, the parameter values can be set within extended limits. Typically, the range of the extended limits is dictated by the physical restrictions of the camera's electronic devices, such as the absolute limits of the camera's variable gain control.



Currently, the parameter limits can only be removed on the gain and the prelines features.

### Removing the Parameter Limits

Removing the limits for a parameter is a two step process:

- Use the Parameter Selector to select the parameter whose limits you wish to remove.
- Set the value of the Remove Limits parameter.

You can use the pylon API to set the Parameter Selector and the value of the Remove Limits parameter from within your application software. The following code snippet illustrates using the API to set the selector and the parameter value:

```
// Select the Gain parameter
Camera.ParameterSelector.SetValue( ParameterSelector_Gain );

// Remove the factory limits for the selected parameter (Gain)
Camera.RemoveLimits.SetValue( true );
```

You can also use the Basler pylon Viewer application to easily set the parameters. Note that the remove parameter limits feature will only be available at the "guru" viewing level.

For more information about the pylon API and the pylon Viewer, see Section 3 on [page 21](#).

## 10.5 Digital Shift

The digital shift feature lets you change the group of bits that is output from each ADC in the camera. Using the digital shift feature will effectively multiply the output of the camera by 2 times, 4 times, 8 times, or 16 times. The next two sections describe how the digital shift feature works when the camera is set for a 12 bit pixel format and when it is set for a 8 bit pixel format. There is also a section describing precautions that you must observe when using the digital shift feature and a section that describes enabling and setting the digital shift feature.

### 10.5.1 Digital Shift with 12 Bit Pixel Formats

#### No Shift

As mentioned in the Functional Description section of this manual, the camera uses 12 bit ADCs to digitize the output from the imaging sensor. When the camera is set for a pixel format that outputs pixel data at 12 bit effective depth, by default, the camera transmits the 12 bits that are output from each ADC.

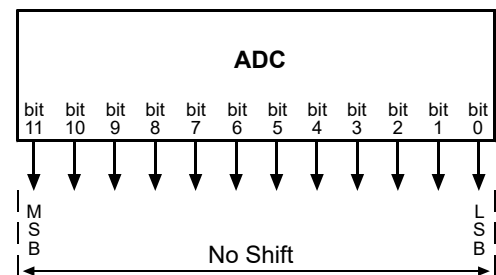

#### Shift by 1

When the camera is set to shift by 1, the output from the camera will include bit 10 through bit 0 from each ADC along with a zero as an LSB.

The result of shifting once is that the output of the camera is effectively multiplied by 2. For example, assume that the camera is set for no shift, that it is viewing a uniform white target, and that under these conditions the reading for the brightest pixel is 100. If you changed the digital shift setting to shift by 1, the reading would increase to 200.

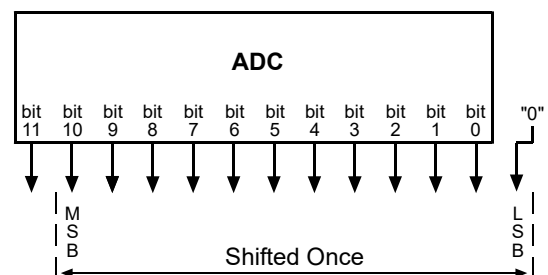

When the camera is set to shift by 1, the least significant bit output from the camera for each pixel value will be 0. This means that no odd gray values can be output and that the gray value scale will only include values of 2, 4, 6, 8, 10, and so on. This absence of some gray values is commonly referred to as "missing codes".

If the pixel values being output by the camera's sensor are high enough to set bit 11 to 1, we recommend not using shift by 1. If you do nonetheless, all bits output from the camera will automatically be set to 1. Therefore, you should only use the shift by 1 setting when your pixel readings with a 12 bit pixel format selected and with digital shift disabled are all less than 2048.

### Shift by 2

When the camera is set to shift by 2, the output from the camera will include bit 9 through bit 0 from each ADC along with 2 zeros as LSBs.

The result of shifting twice is that the output of the camera is effectively multiplied by 4.

When the camera is set to shift by 2, the 2 least significant bits output from the camera for each pixel value will be 0. This means that the gray value scale will only include every 4th gray value, for example, 4, 8, 12, 16, 20, and so on.

If the pixel values being output by the camera's sensor are high enough to set bit 10 or bit 11 to 1, we recommend not using shift by 2. If you do nonetheless, all bits output from the camera will automatically be set to 1. Therefore, you should only use the shift by 2 setting when your pixel readings with a 12 bit pixel format selected and with digital shift disabled are all less than 1024.

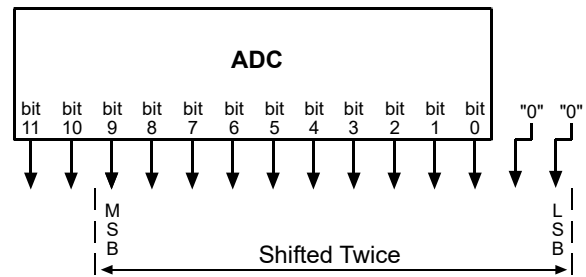

### Shift By 3

When the camera is set to shift by 3, the output from the camera will include bit 8 through bit 0 from each ADC along with 3 zeros as LSBs.

The result of shifting 3 times is that the output of the camera is effectively multiplied by 8.

When the camera is set to shift by 3, the 3 least significant bits output from the camera for each pixel value will be 0. This means that the gray value scale will only include every 8th gray value, for example, 8, 16, 24, 32, and so on.

If the pixel values being output by the camera's sensor are high enough to set bit 9, bit 10, or bit 11 to 1, we recommend not using shift by 3. If you do nonetheless, all bits output from the camera will automatically be set to 1. Therefore, you should only use the shift by 3 setting when your pixel readings with a 12 bit pixel format selected and with digital shift disabled are all less than 512.

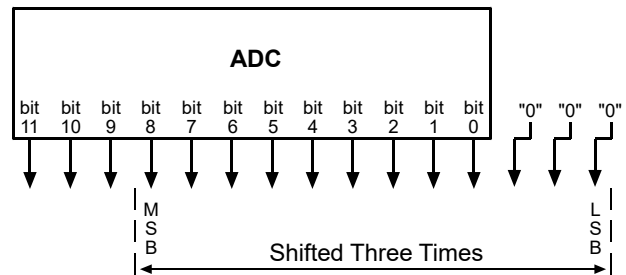

### Shift By 4

When the camera is set to shift by 4, the output from the camera will include bit 7 through bit 0 from each ADC along with 4 zeros as LSBs.

The result of shifting 4 times is that the output of the camera is effectively multiplied by 16.

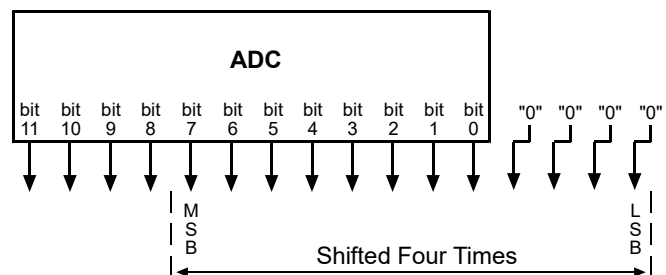

When the camera is set to shift by 4, the 4 least significant bits output from the camera for each pixel value will be 0. This means that the gray value scale will only include every 16th gray value, for example, 16, 32, 48, 64, and so on.

If the pixel values being output by the camera's sensor are high enough to set bit 8, bit 9, bit 10, or bit 11 to 1, we recommend not using shift by 4. If you do nonetheless, all bits output from the camera will automatically be set to 1. Therefore, you should only use the shift by 4 setting when your pixel readings with a 12 bit pixel format selected and with digital shift disabled are all less than 256.

## 10.5.2 Digital Shift with 8 Bit Pixel Formats

### No Shift

As mentioned in the Functional Description section of this manual, the camera uses 12 bit ADCs to digitize the output from the imaging sensor. When the camera is set for a pixel format that outputs pixel data at 8 bit effective depth, by default, the camera drops the 4 least significant bits from each ADC and transmits the 8 most significant bits (bit 11 through 4).

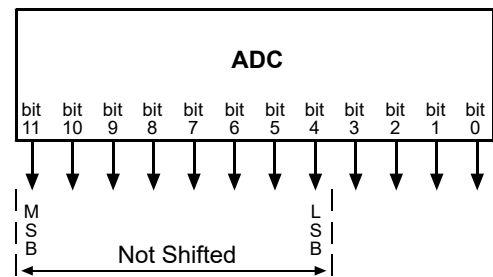

### Shift by 1

When the camera is set to shift by 1, the output from the camera will include bit 10 through bit 3 from each ADC.

The result of shifting once is that the output of the camera is effectively multiplied by 2. For example, assume that the camera is set for no shift, that it is viewing a uniform white target, and that under these conditions the reading for the brightest pixel is 10. If you changed the digital shift setting to shift by 1, the reading would increase to 20.

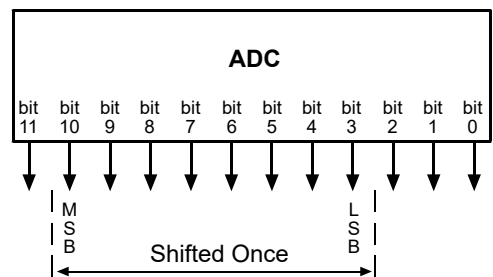

If the pixel values being output by the camera's sensor are high enough to set bit 11 to 1, we recommend not using shift by 1. If you do nonetheless, all bits output from the camera will automatically be set to 1. Therefore, you should only use the shift by 1 setting when your pixel readings with an 8 bit pixel format selected and with digital shift disabled are all less than 128.

### Shift by 2

When the camera is set to shift by 2, the output from the camera will include bit 9 through bit 2 from each ADC.

The result of shifting twice is that the output of the camera is effectively multiplied by 4.

If the pixel values being output by the camera's sensor are high enough to set bit 10 or bit 11 to 1, we recommend not using shift by 2. If you do nonetheless, all bits output from the camera will automatically be set to 1. Therefore, you should only use the shift by 2

setting when your pixel readings with an 8 bit pixel format selected and with digital shift disabled are all less than 64.

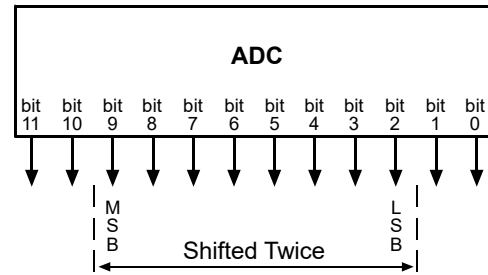

### Shift by 3

When the camera is set to shift by 3, the output from the camera will include bit 8 through bit 1 from each ADC.

The result of shifting three times is that the output of the camera is effectively multiplied by 8.

If the pixel values being output by the camera's sensor are high enough to set bit 9, bit 10, or bit 11 to 1, we recommend not using shift by 3. If you do nonetheless, all bits output from the camera will automatically be set to 1. Therefore, you should only use the shift by 3

setting when your pixel readings with an 8 bit pixel format selected and with digital shift disabled are all less than 32.

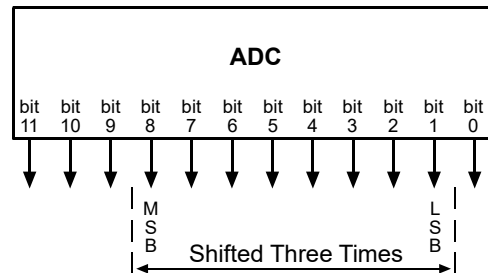

### Shift by 4

When the camera is set to shift by 4, the output from the camera will include bit 7 through bit 0 from each ADC.

The result of shifting four times is that the output of the camera is effectively multiplied by 16.

If the pixel values being output by the camera's sensor are high enough to set bit 8, bit 9, bit 10, or bit 11 to 1, we recommend not using shift by 4. If you do nonetheless, all bits output from the camera will automatically be set to 1. Therefore, you should only use the shift by 4 setting when your pixel readings with an 8 bit pixel format selected and with digital shift disabled are all less than 16.

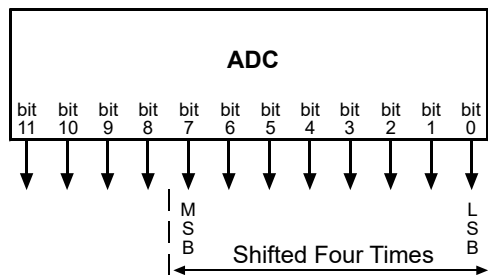

## 10.5.3 Precautions When Using Digital Shift

There are several checks and precautions that you must follow before using the digital shift feature. The checks and precautions differ depending on whether the camera will be set for a 12 bit pixel format or for an 8 bit pixel format in your application.

### **If you will be using a 12 bit pixel format, make this check:**

Use the pylon Viewer or the pylon API to set the camera for a 12 bit pixel format and **no digital shift**.

Check the output of the camera under your normal lighting conditions and note the readings for the brightest pixels.

- If any of the readings are above 2048, do not use digital shift.
- If all of the readings are below 2048, you can safely use the shift by 1 setting.
- If all of the readings are below 1024, you can safely use the shift by 1 or 2 settings.
- If all of the readings are below 512, you can safely use the shift by 1, 2, or 3 settings.
- If all of the readings are below 256, you can safely use the shift by 1, 2, 3, or 4 settings.

### **If you will be using an 8 bit format, make this check:**

Use the pylon Viewer or the pylon API to set the camera for a 8 bit pixel format and **no digital shift**.

Check the output of the camera under your normal lighting conditions and note the readings for the brightest pixels.

- If any of the readings are above 128, do not use digital shift.
- If all of the readings are below 128, you can safely use the shift by 1 setting.
- If all of the readings are below 64, you can safely use the shift by 1 or 2 settings.
- If all of the readings are below 32, you can safely use the shift by 1, 2, or 3 settings.
- If all of the readings are below 16, you can safely use the shift by 1, 2, 3, or 4 settings.

## 10.5.4 Enabling and Setting Digital Shift

### Enabling and Setting Digital Shift Using Basler pylon

You can enable or disable the digital shift feature by setting the value of the Digital Shift parameter. When the parameter is set to zero, digital shift will be disabled. When the parameter is set to 1, 2, 3, or 4, digital shift will be set to shift by 1, shift by 2, shift by 3, or shift by 4 respectively.

You can use the pylon API to set the Digital Shift parameter values from within your application software. The following code snippet illustrates using the API to set the parameter values:

```
// Disable digital shift
Camera.DigitalShift.SetValue( 0 );

// Enable digital shift by 2
Camera.DigitalShift.SetValue( 2 );
```

You can also use the Basler pylon Viewer application to easily set the parameters.

For more information about the pylon API and the pylon Viewer, see Section 3 on [page 21](#).

## 10.6 Image Area of Interest (AOI)

The image area of interest (Image AOI or AOI for short) feature lets you specify a portion of the sensor array and after each image is acquired, only the pixel information from the specified portion of the array will be read out of the sensor and transmitted from the camera.

The area of interest is referenced to the top left corner of the sensor array. The top left corner is designated as column 0 and row 0 as shown in Figure 40.

The location and size of the area of interest is defined by declaring an offset X, a width, an offset Y, and a height. For example, suppose that you specify the offset X as 10, the width as 16, the offset Y as 6, and the height as 10. The area of the array that is bounded by these settings is shown in Figure 40.

The camera will only transmit pixel data from within the area defined by your settings. Information from the pixels outside of the area of interest is discarded.

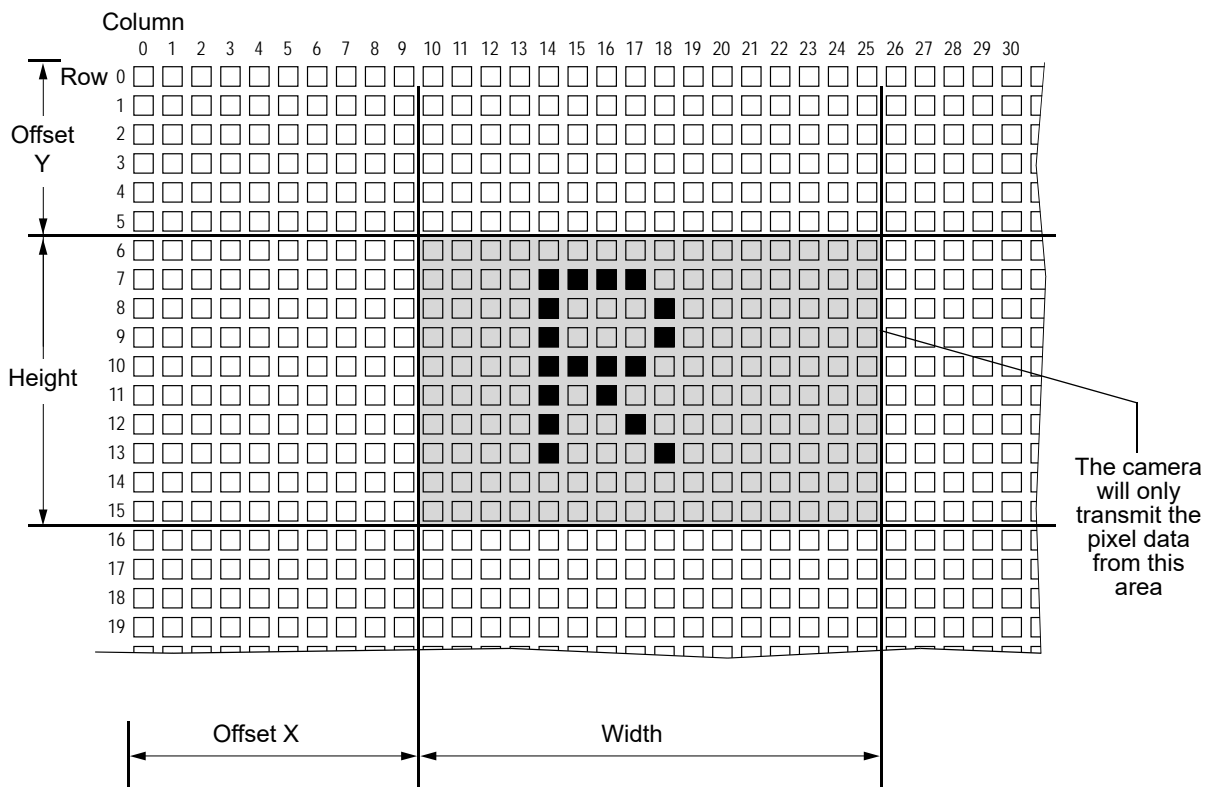

Fig. 40: Area of Interest

One of the main advantages of the AOI feature is that decreasing the height of the AOI can increase the camera's maximum allowed acquisition frame rate.

The AOI feature also includes Center X and a Center Y capabilities. When Center X is enabled, the camera will automatically center the AOI along the sensor's X axis (and will disable the Offset X



setting). When Center Y is enabled, the camera will automatically center the AOI along the sensor's Y axis (and will disable the Offset Y setting).



Note that the maximum allowed frame rate decreases if the Image AOI is significantly displaced from the sensor's center. This is particularly true for a displacement towards the upper part of the sensor.

For more information about how changing the AOI height affects the maximum allowed frame rate, see Section 7.9 on [page 93](#).

## 10.6.1 Setting the Image AOI

By default, the image AOI is set to use the nominal resolution for your camera model (see Section 1.2 on [page 2](#) to determine the nominal resolution of your camera model). You can change the size of the AOI by changing the Width, and Height parameters.

When changing the width and height parameters, the following guidelines must be met:

- On monochrome versions of the camera, the width and height of the AOI can be set in increments of 2.
- On color versions of the camera, the width and height of the AOI can be set in increments of 4.
- As shown in Table 9, the minimum allowed setting for the AOI Height depends on the camera model and whether binning is enabled.

Camera Model	No Vertical Binning	Vertical Binning by 2 Enabled	Vertical Binning by 3 Enabled	Vertical Binning by 4 Enabled
avA1000-100gm	128	64	42	32
avA1000-100gc	128	NA	NA	NA
avA1600-50gm	128	128	128	128
avA1600-50gc	128	NA	NA	NA
avA1900-50gm	128	128	128	128
avA1900-50gc	128	NA	NA	NA
avA2300-25gm	444	444	444	444
avA2300-25gc	444	NA	NA	NA

NA = binning is not available on color cameras

Table 9: Minimum AOI Height Settings



Normally the Width, and Height parameter settings refer to the physical columns and lines in the sensor. But if binning is enabled, these parameters are set in terms of "virtual" columns and lines. For more information about binning, see Section 10.17 on [page 243](#).

## Setting the Image AOI Using Basler pylon

You can set the Offset X, Offset Y, Width, and Height parameter values from within your application software by using the Basler pylon API. The following code snippets illustrate using the API to get the maximum allowed settings and the increments for the Width and Height parameters. They also illustrate setting the Offset X, Offset Y, Width, and Height parameter values and enabling automatic AOI centering.

```
int64_t widthMax = Camera.Width.GetMax( );
int64_t widthInc = Camera.Width.GetInc();
Camera.Width.SetValue( 200 );
Camera.OffsetX.SetValue( 100 );

int64_t heightMax = Camera.Height.GetMax( );
int64_t heightInc = Camera.Height.GetInc();
Camera.Height.SetValue( 200 );
Camera.OffsetY.SetValue( 100 );

// Enable automatic X and Y centering
Camera.CenterX.SetValue( true );
Camera.CenterY.SetValue( true );
```

You can also use the Basler pylon Viewer application to easily set the parameters.

For more information about the pylon API and the pylon Viewer, see Section 3 on [page 21](#).

## 10.6.2 Prelines

As you work with the camera's AOI feature, you may notice that in some situations dark areas appear near the top and the bottom of acquired images as shown in Figure 41. (The image in the figure was acquired using a light gray test pattern.)

These dark areas typically will not be present when large AOIs are used, but will become more noticeable when the AOI height is smaller. The effect will be most noticeable when the AOI height is very small. The effect will be especially apparent if the area of the sensor outside of the AOI is very brightly illuminated.

The prelines feature is designed to minimize this effect. The minimum and maximum settings for the Prelines parameter depend on your camera model as shown in Table 10. Higher prelines settings result in better elimination of any dark areas at the top and bottom of the acquired images. At the highest setting, the prelines feature will minimize or eliminate these dark areas even when the AOI is very small.



Fig. 41: Dark Areas in Small AOI

Camera Model	Min Setting	Max Setting
avA1000-100gm/gc	1	192
avA1600-50gm/gc	1	192
avA1900-50gm/gc	1	192
avA2300-25gm/gc	1	192

Table 10: Minimum and Maximum Preamble Settings

There is a trade-off when using the prelines feature. As mentioned earlier in this section, the camera's maximum allowed frame rate will typically increase as the height of the AOI is made smaller. Using the prelines feature impacts the relationship between the AOI height and the maximum frame rate. When you use a large prelines setting, you will see less of an increase in the maximum allowed frame rate as you make the AOI height smaller.

## Setting the Prelines

You can use the pylon API to set the Prelines parameter value from within your application software. The following code snippet illustrates using the API to set the parameter value:

```
Camera.Prelines.SetValue( 48 );
```

You can also use the Basler pylon Viewer application to easily set the parameters.

For more information about the pylon API and the pylon Viewer, see Section 3 on [page 21](#).

## 10.7 Auto Functions



Note that on cameras delivered from the factory, all auto functions will become disabled whenever you power on or reset the camera.

If you load the auto functions factory set as the default configuration set and the default configuration set is designated as the "startup" set, by default the exposure auto function is enabled.

To change this behavior, you must change the configuration set settings. For more information about configuration sets, see Section 10.19 on [page 247](#).



The auto functions feature will not work, if the sequencer feature is enabled. For more information about the sequencer feature, see Section 10.10 on [page 185](#).

### 10.7.1 Common Characteristics

Auto functions control image properties and are the "automatic" counterparts of certain features, such as the gain feature or the white balance feature, which normally require "manually" setting the related parameter values. Auto functions are particularly useful when an image property must be adjusted quickly to achieve a specific target value and when a specific target value must be kept constant in a series of images.

An Auto Function Area of Interest (Auto Function AOI) lets you designate a specific part of the image as the base for adjusting an image property. Each auto function uses the pixel data from an Auto Function AOI for automatically adjusting a parameter value and, accordingly, for controlling the related image property. Some auto functions always share an Auto Function AOI.

An auto function automatically adjusts a parameter value until the related image property reaches a target value, and the parameter value cannot be manually set.

For some auto functions, the target value is fixed. For other auto functions, the target value can be set, as can the limits between which the related parameter value will be automatically adjusted. For example, the gain auto function lets you set an average gray value for the image as a target value and also set a lower and an upper limit for the gain parameter value.

Generally, the different auto functions can operate at the same time. For more information, see the following sections describing the individual auto functions.



A target value for an image property can only be reached if it is in accord with all pertinent camera settings and with the general circumstances used for capturing images. Otherwise, the target value will only be approached.

For example, with a short exposure time, insufficient illumination, and a low setting for the upper limit of the gain parameter value, the Gain Auto function may not be able to achieve the current target average gray value setting for the image.



You can use an auto function when binning is enabled (monochrome cameras only). An auto function uses the binned pixel data and controls the image property of the binned image.

## 10.7.2 Auto Function Operating Modes

The following auto function modes of operation are available:

- The auto functions provide the "**once**" mode of operation. When the "once" mode of operation is selected, the parameter values are automatically adjusted until the related image property reaches the target value. After the automatic parameter value adjustment is complete, the auto function will automatically be set to "off" and the new parameter value will be applied to the following images.

The parameter value can be changed by using the "once" mode of operation again, by using the "continuous" mode of operation, or by manual adjustment.



If an auto function is set to the "once" operation mode and if the circumstances will not allow reaching a target value for an image property, the auto function will try to reach the target value for a maximum of 30 images and will then be set to "off".

- The auto functions also provide a "**continuous**" mode of operation where the parameter value is adjusted repeatedly while images are acquired.

Depending on the current frame rate, the automatic adjustments will usually be carried out for every or every other image.

The repeated automatic adjustment will proceed until the "once" mode of operation is used or until the auto function is set to "off", in which case the parameter value resulting from the latest automatic adjustment will operate, unless the parameter is manually adjusted.

- When an auto function is set to "off", the parameter value resulting from the latest automatic adjustment will operate, unless the parameter is manually adjusted.



You can enable auto functions and change their settings while the camera is capturing images ("on the fly").



If you have set an auto function to "once" or "continuous" operation mode while the camera was continuously capturing images, the auto function will become effective with a short delay and the first few images may not be affected by the auto function.

## 10.7.3 Auto Function AOIs

Each auto function uses the pixel data from an Auto Function AOI for automatically adjusting a parameter value, and accordingly, for controlling the related image property. Within these limitations, auto functions can be assigned to Auto Function AOIs as desired.

Each Auto Function AOI has its own specific set of parameter settings, and the parameter settings for the Auto Function AOIs are not tied to the settings for the AOI that is used to define the size of captured images (Image AOI). For each Auto Function AOI, you can specify a portion of the sensor array and only the pixel data from the specified portion will be used for auto function control. Note that an Auto Function AOI can be positioned anywhere on the sensor array.

An Auto Function AOI is referenced to the top left corner of the sensor array. The top left corner of the sensor array is designated as column 0 and row 0 as shown in Figure 42.

The location and size of an Auto Function AOI is defined by declaring an X offset (coordinate), a width, a Y offset (coordinate), and a height. For example, suppose that you specify the X offset as 14, the width as 5, the Y offset as 7, and the height as 6. The area of the array that is bounded by these settings is shown in Figure 42.

Only the pixel data from the area of overlap between the Auto Function AOI defined by your settings and the Image AOI will be used by the related auto function.

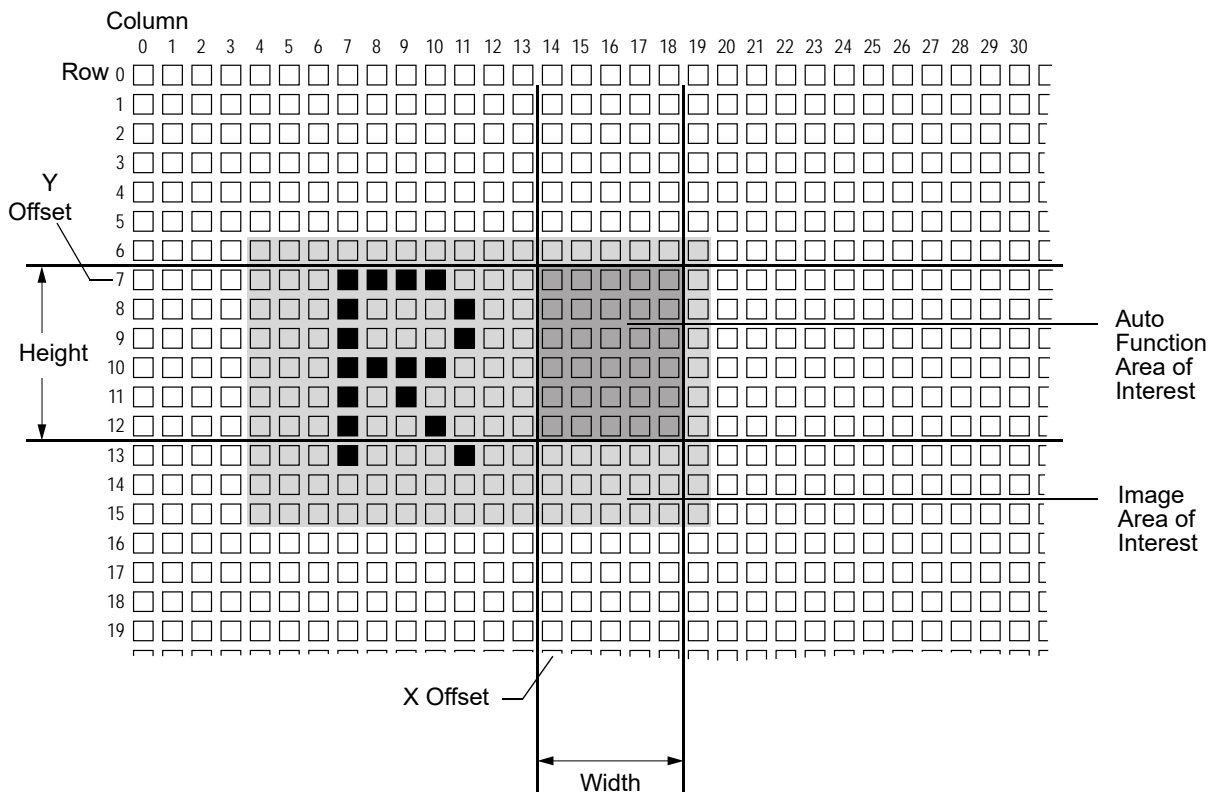

Fig. 42: Auto Function Area of Interest and Image Area of Interest



### 10.7.3.1 Assignment of an Auto Function to an Auto Function AOI

By default, the Gain Auto and the Exposure Auto auto functions are assigned to Auto Function AOI 1 and the Balance White Auto auto function is assigned to Auto Function AOI 2. The assignments can, however, be set as desired. For example, the Balance White Auto auto function can be assigned to Auto Function AOI 1 or all auto functions can be assigned to the same Auto Function AOI.



We strongly recommend that you do not assign an auto function to more than one Auto Function AOI even though this can be done.

**Limitation:** For the purpose of making assignments, the Gain Auto and the Exposure Auto auto functions are always considered as a single "Intensity" auto function and therefore the Auto Function AOI assignment is always identical for both auto functions. For example, if you assign the "Intensity" auto function to Auto Function AOI 2 the Gain Auto and the Exposure Auto auto functions are both assigned to Auto Function AOI 2. This does not imply, however, that the Gain Auto and the Exposure Auto auto functions must always be used at the same time.

You can assign auto functions to Auto Function AOIs from within your application software by using the pylon API.

As an example, the following code snippet illustrates using the API to assign the Gain Auto and Exposure Auto auto function - considered as a single "Intensity" auto function - and the Exposure Auto auto function to Auto Function AOI 1.

The snippet also illustrates disabling the unused Auto Function AOI 2 to avoid assigning any auto function to more than one Auto Function AOI.

```
// Select Auto Function AOI 1
// Assign auto functions to the selected Auto Function AOI
Camera.AutoFunctionAOISelector.SetValue( AutoFunctionAOISelector_AOI1 );
Camera.AutoFunctionAOIUsageIntensity.SetValue( true );
Camera.AutoFunctionAOIUsageWhiteBalance.SetValue( true );

// Select the unused Auto Function AOI 2
// Disable the unused Auto Function AOI
Camera.AutoFunctionAOISelector.SetValue( AutoFunctionAOISelector_AOI2 );
Camera.AutoFunctionAOIUsageIntensity.SetValue( false );
Camera.AutoFunctionAOIUsageWhiteBalance.SetValue( false );
```

You can also use the Basler pylon Viewer application to easily set the parameters.

### 10.7.3.2 Positioning of an Auto Function AOI Relative to the Image AOI

The size and position of an Auto Function AOI can be, but need not be, identical to the size and position of the Image AOI. Note that the overlap between an Auto Function AOI and the Image AOI determines whether and to what extent the auto function will control the related image property. Only the pixel data from the areas of overlap of an Auto Function AOI and the Image AOI will be used by the auto function to control the image property of the entire image.

Different degrees of overlap are illustrated in [Figure 43](#). The hatched areas in the figure indicate areas of overlap.

- If the Auto Function AOI is completely included in the Image AOI (see (a) in [Figure 43](#)), all pixel data from the Auto Function AOI will be used to control the image property.
- If the Image AOI is completely included in the Auto Function AOI (see (b) in [Figure 43](#)), only the pixel data from the Image AOI will be used to control the image property.
- If the Image AOI only partially overlaps the Auto Function AOI (see (c) in [Figure 43](#)), only the pixel data from the area of partial overlap will be used to control the image property.
- If the Auto Function AOI does not overlap the Image AOI (see (d) in [Figure 43](#)), the Auto Function will **not** control the image property. For details, see the sections below, describing the individual auto functions.



We strongly recommend completely including the Auto Function AOI within the Image AOI, or, depending on your needs, setting identical positions and sizes for the Auto Function AOIs and the Image AOI.



You can use auto functions when also using the reverse X and reverse Y mirroring features. For information about the behavior of Auto Function AOIs when also using the reverse X or reverse Y mirroring feature, see the "Mirror Image" section.

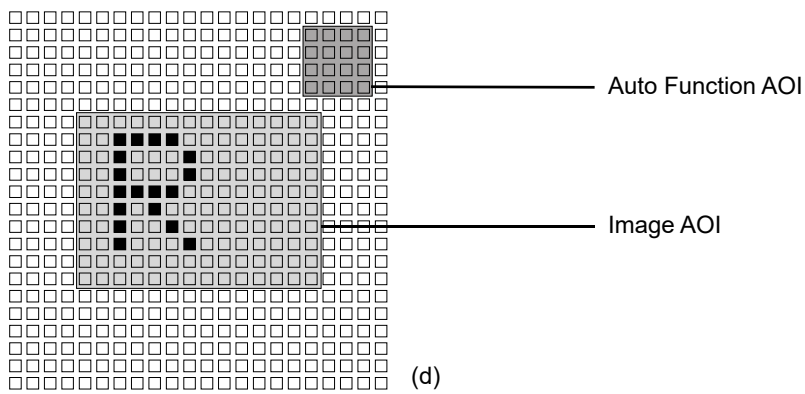
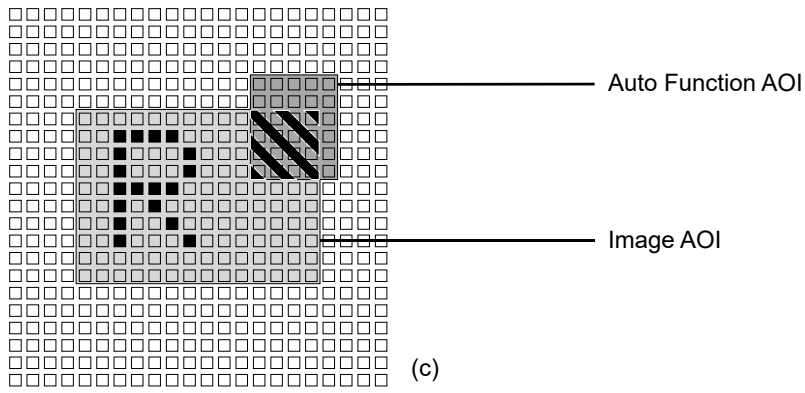
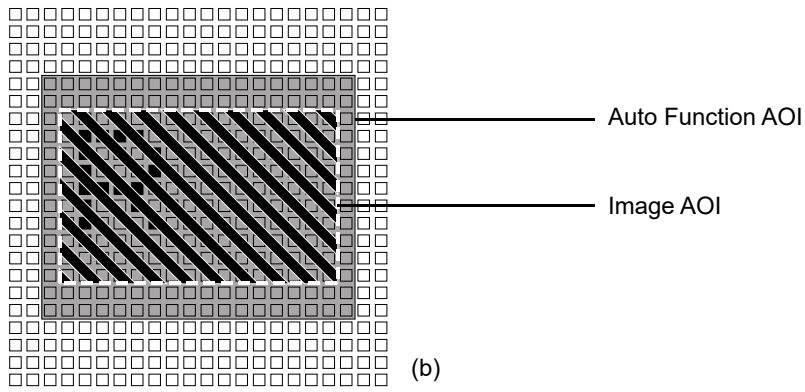
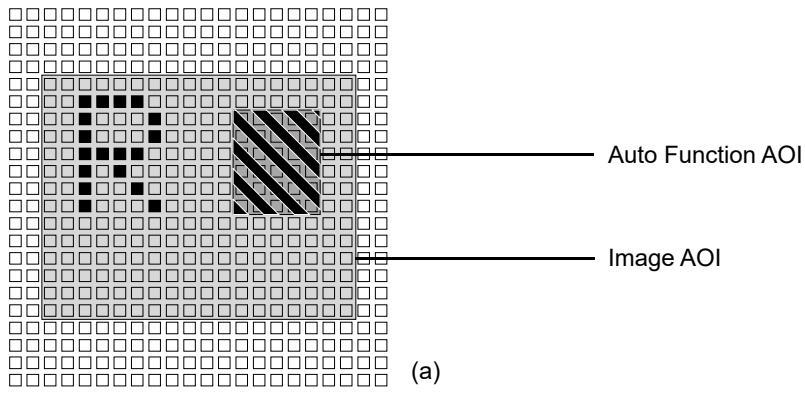

Fig. 43: Various Degrees of Overlap Between the Auto Function AOI and the Image AOI

### 10.7.3.3 Setting an Auto Function AOI

Setting an Auto Function AOI is a two-step process: You must first select the Auto Function AOI that was related to the auto function that you want to use and then set the position and the size of the Auto Function AOI.

By default, an Auto Function AOI is set to the full resolution of the camera's sensor. You can change the position and the size of an Auto Function AOI by changing the value of the Auto Function AOI's X Offset, Y Offset, Width, and Height parameters.

- The value of the X Offset parameter determines the starting column for the Auto Function AOI.
- The value of the Y Offset parameter determines the starting line for the Auto Function AOI.
- The value of the Width parameter determines the width of the Auto Function AOI.
- The value of the Height parameter determines the height of the Auto Function AOI.

When you are setting an Auto Function AOI, you must follow these guidelines:

- The sum of the X Offset setting plus the Width setting must not exceed the width of the camera's sensor. For example, on the avA1000-100gm, the sum of the X Offset setting plus the Width setting must not exceed 1040.
- The sum of the Y Offset setting plus the Height setting must not exceed the height of the camera's sensor. For example, on the avA1000-100gm, the sum of the X Offset setting plus the Width setting must not exceed 1040.
- On monochrome versions of the camera, the width and height of the AOI can be set in increments of 2.
- On color versions of the camera, the width and height of the AOI can be set in increments of 4.



On color cameras, the same increments apply for setting Auto Function AOIs as for the Image AOI.



Normally, the X Offset, Y Offset, Width, and Height parameter settings for an Auto Function AOI refer to the physical columns and lines in the sensor. But if binning is enabled (monochrome cameras only), these parameters are set in terms of "virtual" columns and lines, i.e., the settings for an Auto Function AOI will refer to the binned lines and columns in the sensor and not to the physical lines in the sensor as they normally would.

For more information about the concept of a "virtual" sensor, see Section 10.17 on [page 243](#).

You can select an Auto Function AOI and set the X Offset, Y Offset, Width, and Height parameter values for the Auto Function AOI from within your application software by using the pylon API. The following code snippet illustrates using the API to select Auto Function AOI one and to get the maximum allowed settings for the Width and Height parameters. The snippet also illustrates setting the X Offset, Y Offset, Width, and Height parameter values.

```
// Select auto function AOI 1
// Set position and size of the selected auto function AOI
Camera.AutoFunctionAOISelector.SetValue( AutoFunctionAOISelector_AOI1 );
Camera.AutoFunctionAOIOffsetX.SetValue( 0 );
Camera.AutoFunctionAOIOffsetY.SetValue( 0 );
Camera.AutoFunctionAOIWidth.SetValue( Camera.AutoFunctionAOIWidth.GetMax() );
Camera.AutoFunctionAOIHeight.SetValue( Camera.AutoFunctionAOIHeight.GetMax() );
```

You can also use the Basler pylon Viewer application to easily set the parameters.

For more information about the pylon API and the pylon Viewer, see Section 3 on [page 21](#).

## 10.7.4 Using an Auto Function

To use an auto function, carry out the following steps:

1. Select an Auto Function AOI.
2. Assign the auto function you want to use to the selected Auto Function AOI.
3. Unassign the auto function you want to use from the other Auto Function AOI.
4. Set the position and size of the Auto Function AOI.
5. If necessary, set the lower and upper limits for the auto functions's parameter value.
6. If necessary, set the target value.
7. Set the `GrayValueAdjustmentDampingAbs` parameter.
8. If necessary, set the auto function profile to define priorities between auto functions.
9. Enable the auto function by setting it to "once" or "continuous".

For more information about the individual settings, see the next sections that describe the individual auto functions.

## 10.7.5 Gain Auto



Note that on cameras delivered from the factory, all auto functions will become disabled whenever you power on or reset the camera.

If you load the auto functions factory set as the default configuration set and the default configuration set is designated as the "startup" set, by default the exposure auto function is enabled.

To change this behavior, you must change the configuration set settings. For more information about configuration sets, see Section 10.19 on [page 247](#).

Gain Auto is the "automatic" counterpart to manually setting the Gain Raw All. When the gain auto function is operational, the camera will automatically adjust Gain Raw All within set limits until a target average gray value for the pixel data from the related Auto Function AOI is reached. (Automatic adjustments for Gain Tap 1, Gain Tap 2, Gain Tap 3, and Gain Tap 4 are not available.)

The gain auto function can be operated in the "once" and the "continuous" modes of operation.

If the related Auto Function AOI does not overlap the Image AOI (see the "Auto Function AOI" section) the pixel data from the Auto Function AOI will not be used to control the gain. Instead, the current manual setting for Gain Raw All will control the gain.

The gain auto function and the exposure auto function can be used at the same time. In this case, the auto function profile feature also takes effect. By default, the auto function profile feature minimizes gain.

For more information about

- setting the gain "manually", see Section 10.2 on [page 145](#).
- the auto function profile Section 10.7.8 on [page 178](#).

The limits within which the camera will adjust the Gain Raw All are defined by the Auto Gain Raw Upper Limit and the Auto Gain Raw Lower Limit parameters. The minimum and maximum allowed settings for the Auto Gain Raw Upper Limit and Auto Gain Raw Lower Limit parameters depend on the current pixel format, on the current settings for binning, and on whether or not the parameter limits for manually setting the gain feature are disabled.

The Auto Target Value parameter defines the target average gray value that the gain auto function will attempt to achieve when it is automatically adjusting the Gain Raw All. The target average gray value can range from 50 (black) to 205 (white) when the camera is set for 8 bit output. When the camera is set for 12 bit output, the target gray value can range from 800 to 3280.

Setting the gain auto functionality using Basler pylon is a several step process:

- Select the Auto Function AOI that was related to Gain Auto.
- Set the value of the Offset X, Offset Y, Width, and Height parameters for the AOI.
- Set the Gain Selector to All.
- Set the value of the Auto Gain Raw Lower Limit and Auto Gain Raw Upper Limit parameters.
- Set the value of the Auto Target Value parameter.
- Set the value of the Gain Auto parameter for the "once" or the "continuous" mode of operation.

You can set the gain auto functionality from within your application software by using the pylon API. The following code snippets illustrate using the API to set the exposure auto functionality:

```
// Select the auto function AOI that was related to Gain Auto
// It is assumed here that auto function AOI 1 was related to Gain Auto
Camera.AutoFunctionAOISelector.SetValue( AutoFunctionAOISelector_AOI1 );

// Set the position and size of selected auto function AOI. In this example, we set
// auto function AOI to cover the entire sensor.
Camera.AutoFunctionAOIOffsetX.SetValue( 0 );
Camera.AutoFunctionAOIOffsetY.SetValue( 0 );
Camera.AutoFunctionAOIWidth.SetValue( Camera.AutoFunctionAOIWidth.GetMax() );
Camera.AutoFunctionAOIHeight.SetValue( Camera.AutoFunctionAOIHeight.GetMax() );

// Select gain all and set the upper and lower gain limits for the gain
// auto function.
Camera.GainSelector.SetValue( GainSelector_All );
Camera.AutoGainRawLowerLimit.SetValue( Camera.GainRaw.GetMin() );
Camera.AutoGainRawUpperLimit.SetValue( Camera.GainRaw.GetMax() );

// Set target gray value for the gain auto function.
Camera.AutoTargetValue.SetValue( 128 );

// Set the mode of operation for gain auto function.
Camera.GainAuto.SetValue( GainAuto_Once );
```

You can also use the Basler pylon Viewer application to easily set the parameters.

For more information about the pylon API and the pylon Viewer, see Section 3 on [page 21](#).

## 10.7.6 Exposure Auto



Note that on cameras delivered from the factory, all auto functions will become disabled whenever you power on or reset the camera.

If you load the auto functions factory set as the default configuration set and the default configuration set is designated as the "startup" set, by default the exposure auto function is enabled.

To change this behavior, you must change the configuration set settings. For more information about configuration sets, see Section 10.19 on [page 247](#).

Exposure Auto is the "automatic" counterpart to manually setting the Exposure Time Abs parameter. The exposure auto function automatically adjusts the Exposure Time Abs parameter within set limits until a target average gray value for the pixel data from the related Auto Function AOI is reached.

The exposure auto function can be operated in the "once" and "continuous" modes of operation.

If the related Auto Function AOI does not overlap the Image AOI (see the "Auto Function AOI" section), the pixel data from the Auto Function AOI will not be used to control the exposure time. Instead, the current manual setting for the Exposure Time Abs parameter will control the exposure time.

The exposure auto function and the gain auto function can be used at the same time. In this case, the auto function profile feature also takes effect. By default, the auto function profile feature minimizes gain.

When trigger width exposure mode is selected, the exposure auto function is not available.

For more information about

- setting the exposure time "manually", see Section 7.5 on [page 82](#).
- the trigger width exposure mode, see Section 7.4.3.2 on [page 78](#).
- about the auto function profile Section 10.7.8 on [page 178](#).

The limits within which the camera will adjust the Auto Exposure Time Abs parameter are defined by the Auto Exposure Time Abs Upper Limit and the Auto Exposure Time Abs Lower Limit parameters. The current minimum and the maximum allowed settings for the Auto Exposure Time Abs Upper Limit parameter and the Auto Exposure Time Abs Lower Limit parameters depend on the minimum allowed and maximum possible exposure time for your camera model.

The Auto Target Value parameter defines the target average gray value that the exposure auto function will attempt to achieve when it is automatically adjusting the Exposure Time Abs value. The target average gray value can range from 50 (black) to 205 (white) when the camera is set for 8 bit output. When the camera is set for 12 bit output, the target gray value can range from 800 to 3280.



If the Exposure Time Abs Upper Limit Parameter is set to a sufficiently high value, the camera's maximum allowed frame rate may be decreased.



Setting the exposure auto functionality using Basler pylon is a several step process:

- Select the Auto Function AOI that was related to Exposure Auto.
- Set the value of the Offset X, Offset Y, Width, and Height parameters for the AOI.
- Set the value of the Auto Exposure Time Abs Lower Limit and Auto Exposure Time Abs Upper Limit parameters.
- Set the value of the Auto Target Value parameter.
- Set the value of the Exposure Auto parameter for the "once" or the "continuous" mode of operation.

You can set the exposure auto functionality from within your application software by using the pylon API. The following code snippets illustrate using the API to set the exposure auto functionality:

```
// Select auto function AOI that was related to Exposure Auto
// It is assumed here that auto function AOI 1 was related to Exposure Auto
Camera.AutoFunctionAOISelector.SetValue( AutoFunctionAOISelector_AOI1 );

// Set the position and size of selected auto function AOI. In this example, we set
// auto function AOI to cover the entire sensor.
Camera.AutoFunctionAOIOffsetX.SetValue( 0 );
Camera.AutoFunctionAOIOffsetY.SetValue( 0 );
Camera.AutoFunctionAOIWidth.SetValue( Camera.AutoFunctionAOIWidth.GetMax() );
Camera.AutoFunctionAOIHeight.SetValue( Camera.AutoFunctionAOIHeight.GetMax() );

// Set the exposure time limits for the exposure auto function
Camera.AutoExposureTimeAbsLowerLimit.SetValue( 1000 );
Camera.AutoExposureTimeAbsUpperLimit.SetValue( 1.0E6 );

// Set target gray value for the exposure auto function
// (If gain auto is enabled, this target is also used for gain auto control)
Camera.AutoTargetValue.SetValue( 128 );

// Set the mode of operation for the exposure auto function
Camera.ExposureAuto.SetValue( ExposureAuto_Continuous );
```

You can also use the Basler pylon Viewer application to easily set the parameters.

For more information about the pylon API and the pylon Viewer, see Section 3 on [page 21](#).

## 10.7.7 Gray Value Adjustment Damping

The gray value adjustment damping controls the rate by which pixel gray values are changed when Exposure Auto and/or Gain Auto are enabled.

If an adjustment damping factor is used, the gray value target value is not immediately reached, but after a certain "delay". This can be useful, for example, when objects move into the camera's view area and where the light conditions are gradually changing due to the moving objects.

By default, the gray value adjustment damping is set to 0.6836. This is a setting where the damping control is as stable and quick as possible.

### Setting the Adjustment Damping

The gray value adjustment damping is determined by the value of the Gray Value Adjustment Damping Abs parameter. The parameter can be set in a range from 0.0 to 0.78125.

The higher the value, the lower the adjustment damping is, i.e.

- the sooner the target value will be reached,
- the adaptation is realized over a smaller number of frames.

#### Examples:

0.6836 = Default value the camera starts with. There is a relatively immediate continuous adaptation to the target gray value.

If you set the value to 0.5, there would be more interim steps; the target value would be reached after a "higher" number of frames.

You can set the gray value adjustment damping from within your application software by using the pylon API. The following code snippets illustrate using the API to set the gray value adjustment damping:

```
Camera.GrayValueAdjustmentDampingRaw.SetValue(600);  
Camera.GrayValueAdjustmentDampingAbs.SetValue(0.5859);
```

You can also use the Basler pylon Viewer application to easily set the parameters.

## 10.7.8 Auto Function Profile

If you want to use the gain auto function and the exposure auto function at the same time, the auto function profile feature also takes effect. The auto function profile specifies whether the gain or the exposure time will be kept as low as possible when the camera is making automatic adjustments to achieve a target average gray value for the pixel data from the Auto Function AOI that was related to the gain auto and the exposure auto function. By default, the auto function profile feature minimizes gain.

If you want to use the gain auto and the exposure auto functions at the same time, you should set both functions for the continuous mode of operation.

Setting the camera with Basler pylon to use the gain auto function and the exposure auto function at the same time is a several step process:

- Set the value of the Auto Function Profile parameter to specify whether gain or exposure time will be minimized during automatic adjustments.
- Set the value of the Gain Auto parameter to the "continuous" mode of operation.
- Set the value of the Exposure Auto parameter to the "continuous" mode of operation.

You can set the auto function profile from within your application software by using the pylon API. The following code snippet illustrates using the API to set the auto function profile. As an example, Gain Auto is set to be minimized during adjustments:

```
// Use GainAuto and ExposureAuto simultaneously
Camera.AutoFunctionProfile.SetValue( AutoFunctionProfile_GainMinimum );
Camera.GainAuto.SetValue( GainAuto_Continuous );
Camera.ExposureAuto.SetValue( ExposureAuto_Continuous );
```

You can also use the Basler pylon Viewer application to easily set the parameters.

For more information about the pylon API and the pylon Viewer, see Section 3 on [page 21](#).

## 10.7.9 Balance White Auto



Note that on cameras delivered from the factory, all auto functions will become disabled whenever you power on or reset the camera.

If you load the auto functions factory set as the default configuration set and the default configuration set is designated as the "startup" set, by default the exposure auto function is enabled.

To change this behavior, you must change the configuration set settings. For more information about configuration sets, see Section 10.19 on [page 247](#).

Balance White Auto is the "automatic" counterpart to manually setting the white balance. The balance white auto function is only available on color models.

Automatic white balancing is a two-step process. First, the Balance Ratio Abs parameter values for red, green, and blue are each set to 1.5. Then, assuming a "gray world" model, the Balance Ratio Abs parameter values are automatically adjusted such that the average values for the "red" and "blue" pixels match the average value for the "green" pixels.

The balance white auto function uses the Auto Function AOI that was related to the Balance White Auto function. The balance white auto function can be operated in the "once" mode of operation and in the "continuous" mode of operation. For information about the "once" mode of operation and the "continuous" mode of operation, see Section 10.7.2 on [page 166](#).

If the related Auto Function AOI does not overlap the Image AOI (see the "Auto Function AOI" section) the pixel data from the Auto Function AOI will not be used to control the white balance of the image. However, as soon as the Balance White Auto function is set to "once" operation mode, the Balance Ratio parameter values for red, green, and blue are each set to 1.5. These settings will then control the white balance of the image.

For more information about setting the white balance "manually", see Section 8.3.1 on [page 108](#).

Setting the balance white auto functionality using Basler pylon is a several step process:

- Select the Auto Function AOI to which the Balance White Auto is assigned.
- Set the value of the Offset X, Offset Y, Width, and Height parameters for the AOI.
- Set the value of the Exposure Auto parameter for the "once" or the "continuous" mode of operation.

You can set the white balance auto functionality from within your application software by using the pylon API. The following code snippets illustrate using the API to set the balance auto functionality:

```
// Select Auto Function AOI to which the Balance White Auto function is assigned
// For this example, assume that the Balance White Auto function is
// assigned to Auto AOI 2
Camera.AutoFunctionAOISelector.SetValue( AutoFunctionAOISelector_AOI2 );

// Set the position and size of selected auto function AOI. In this example, we set
// auto function AOI to cover the entire sensor.
```

```
Camera.AutoFunctionAOIOffsetX.SetValue( 0 );
Camera.AutoFunctionAOIOffsetY.SetValue( 0 );
Camera.AutoFunctionAOIWidth.SetValue( Camera.AutoFunctionAOIWidth.GetMax() );
Camera.AutoFunctionAOIHeight.SetValue( Camera.AutoFunctionAOIHeight.GetMax() );

// Set mode of operation for balance white auto function
Camera.BalanceWhiteAuto.SetValue( BalanceWhiteAuto_Once );
```

You can also use the Basler pylon Viewer application to easily set the parameters.

For more information about the pylon API and the pylon Viewer, see Section 3 on [page 21](#).

## 10.8 Minimum Output Pulse Width

An output signal sent by the camera may be too narrow for some receivers to be detected. To ensure reliable detection, the Minimum Output Pulse Width feature allows you to increase the signal width to a set minimum width:

- If the signal width of the original output signal is narrower than the set minimum the Minimum Output Pulse Width feature will increase the signal width to the set minimum before the signal is sent out of the camera (see the figure below).
- If the signal width of the original output signal is equal to or wider than the set minimum the Minimum Output Pulse Width feature will have no effect. The signal will be sent out of the camera with unmodified signal width.

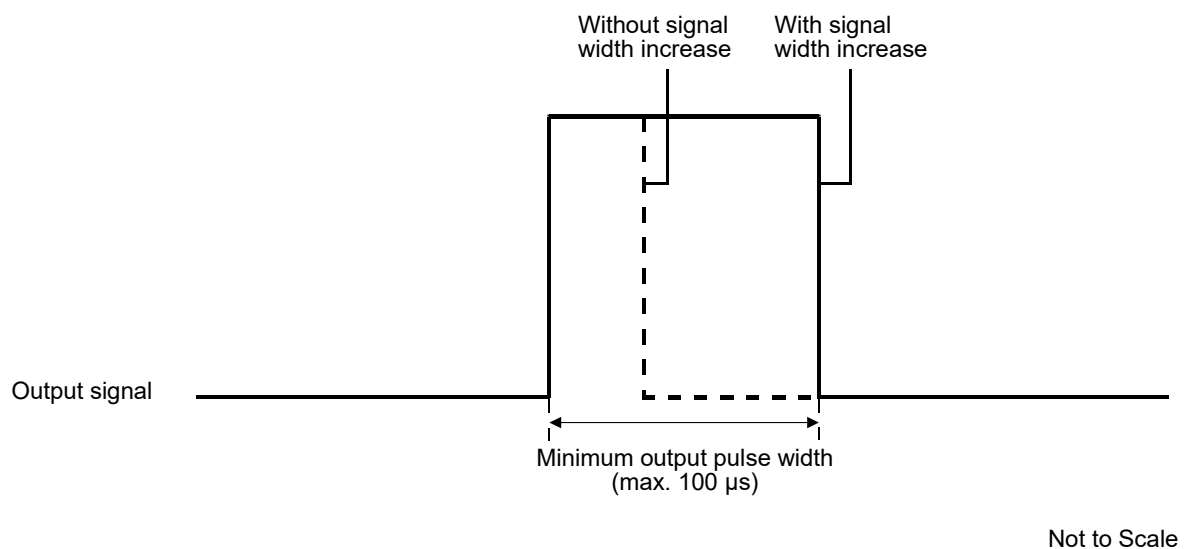

Fig. 44: Increasing the Signal Width of an Output Signal

### Setting the Minimum Output Pulse Width

The minimum output pulse width is determined by the value of the `MinOutPulseWidthAbs` parameter. The parameter is set in microseconds and can be set in a range from 0 to 100  $\mu\text{s}$ .

To set the minimum output pulse width parameter value:

- Use the Line Selector to select the camera output line 1.
- Set the value of the `MinOutPulseWidthAbs` parameter.

You can set the Line Selector and the value of the `MinOutPulseWidthAbs` parameter from within your application software by using the pylon API. The following code snippet illustrates using the API to set the selector and the parameter value:

```
// Select the input line
Camera.LineSelector.SetValue(LineSelector_Out1);

// Set the parameter value to 10.0 microseconds
Camera.MinOutPulseWidthAbs.SetValue(10.0);
```

For detailed information about using the pylon API, refer to the Basler pylon Programmer's Guide and API Reference.

You can also use the Basler pylon Viewer application to easily set the parameters.

For more information about the pylon Viewer, see Section 3.1.1 on [page 22](#).

## 10.9 Error Codes

The camera can detect several user correctable errors. If one of these errors is present, the camera will set an error code and will flash both the yellow and green LEDs in the LED indicator.

Code	Condition	Meaning
0	No Error	The camera has not detected any errors since the last time that the error memory was cleared.
1	Overtrigger	An overtrigger has occurred. The user has applied an acquisition start trigger to the camera when the camera was not in a waiting for acquisition start condition. Or, the user has applied a frame start trigger to the camera when the camera was not in a waiting for frame start condition.
2	User set load	An error occurred when attempting to load a user set. Typically, this means that the user set contains an invalid value. Try loading a different user set.
3	Invalid Parameter	A parameter is set out of range or in an otherwise invalid manner.
4	Over Temperature	The camera has stopped image acquisition due to overheating. Provide adequate cooling to the camera.

Table 11: Error Codes

When the camera detects a user correctable error, it sets the appropriate error code in an error memory. If two or three different detectable errors have occurred, the camera will store the code for each type of error that it has detected (it will store one occurrence of the each code no matter how many times it has detected the corresponding error).

You can use the following procedure to check the error codes:

- Read the value of the Last Error parameter. The Last Error parameter will indicate the last error code stored in the memory.
- Execute the Clear Last Error Command to clear the last error code from the memory.
- Continue reading and clearing the last error until the parameter indicates a No Error code.



## Reading and Clearing the Error Codes Using Basler pylon

You can use the pylon API to read the value of the Last Error parameter and to execute a Clear Last Error command from within your application software. The following code snippets illustrate using the pylon API to read the parameter value and execute the command:

```
// Read the value of the last error code in the memory
LastErrorEnums lasterror = Camera.LastError.GetValue();

// Clear the value of the last error code in the memory
Camera.ClearLastError.Execute( );
```

You can also use the Basler pylon Viewer application to easily set the parameter and execute the command.

## 10.10 Sequencer



The sequencer feature will not work if the auto functions feature is enabled. For more information about the auto functions feature, see Section 10.7 on [page 164](#).



If the sequencer feature is not available, activate the "Full" camera description file. For more information, see Section 10.20 on [page 253](#).

The sequencer feature allows to apply specific sets of configuration parameter settings, called sequence sets, to a sequence of image acquisitions. As the images are acquired, one sequence set after the other is applied. This makes it possible to respond to different imaging requirements and conditions, that may, for example, result from changing illumination, while a sequence of images is acquired.

Three sequence advance modes (auto, controlled and free selection sequence advance modes) provide different schemes for advancing from one sequence set to the next (see below for details).

## The Sequencer and the Active Configuration Set

During operation, the camera is controlled by a set of configuration parameters that reside in the camera's volatile memory. This set of parameters is known as the active configuration set or "active set" for short. When you use the pylon API or the pylon Viewer to make a change to a camera parameter such as the Gain, you are making a change to the active set. And since the active set controls camera operation, you will see a change in camera operation when you change a parameter in the active set. For more information about the active set, see the "Configuration Sets" section.

The parameters in the active set can be divided into two types (as shown in Figure 45):

- "non-sequence" parameters
 

The values of the non-sequence parameters cannot be changed using the sequencer feature.
- "sequence" parameters
 

The values of the sequence parameters can be set very quickly by using sequence sets: Because the sequence sets reside in the camera, you can replace the values in the active set with values from one of the sequence sets almost instantaneously as images are acquired. Using the sequencer feature has no effect on the camera's frame rate.

The sequence set currently defining the parameter values of the active set is also called the "current set".

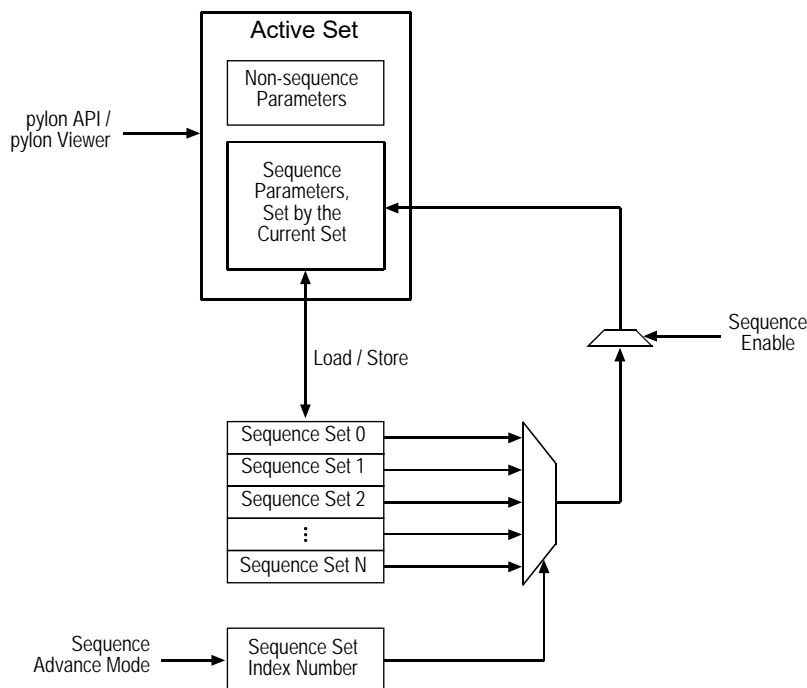

Fig. 45: Sequence Feature Block Diagram

The following parameters are examples of parameters that are included in each sequence set:

Exposure Time	Black Level
Enable Acquisition Frame Rate	Reverse X
Acquisition Frame Rate	Reverse Y
Width	Digital Shift
Height	LUT Enable
X Offset	Color Transformation Value
Y Offset	Color Transformation Matrix Factor
Center X	Color Adjustment Enable
Center Y	Color Adjustment Hue
Chunk Mode Active	Color Adjustment Saturation
Chunk Enable	Light Source Selector
Binning Horizontal	Timer Delay*
Binning Vertical	Timer Duration*
Pixel Format	Timer Delay Timebase*
Test Image	Timer Duration Timebase*
Gain	Sequence Set Executions**
Processed Raw Enable	

\* This parameter is individually available for timer 1, timer 2, timer 3, and timer 4.

\*\*This parameter is only available in auto sequence advance mode.

## Sequence Set Configuration

Before the sequencer feature can be used you must populate the sequence sets with the parameter values of the sequence parameters and store the sequence sets in the camera's memory. Each sequence set is identified by a sequence set index number starting from zero. After storing, the sequence sets are available for use by the sequencer feature.

Some sequence advance modes require the storing of additional settings, for example, the total number of sequence sets you want to use, the number of consecutive uses of a sequence set or the source to control sequence set advance. For details about populating sequence sets and making related settings see the sections below explaining the sequence advance modes.



When the sequencer feature is enabled, the sequence parameter values of the current sequence set cannot be read or changed using the pylon API or the pylon Viewer. Only those sequence parameter values will be displayed that were active before the sequencer was enabled. You will not be able to "see" the parameter values set by the current set.

Make sure the sequencer feature is disabled when configuring sequence sets.



Because the sequence sets only reside in volatile memory they are lost if the camera is reset or switched off. If you are using the sequencer feature, you must populate the sequence sets after each camera reset or startup.

Note also that sequence sets can not be saved in user sets.

## Sequence Advance

As explained above, a sequence set can only control the operation of the camera after its parameter values were loaded into the active set. The loading into the active set and therefore the selection of a sequence set as the current set for a specific image acquisition are performed according to the selected sequence advance mode. The selection of a sequence set as the current set is always linked to the frame start trigger signals unless software commands are used (see below).

Accordingly, a sequence advance mode provides a scheme for advancing from one sequence set to the next as frames are triggered.

The following three sequence advance modes are available:

- **Auto sequence advance mode:** Sequence set advance is automatically controlled by the camera. The camera will cycle through the available sequence sets in ascending sequence set index number as frames are triggered. Individual sequence sets can be used consecutively. After one sequence set cycle is complete another one will start automatically. For more information, see Section 10.10.1 on [page 191](#).
- **Controlled sequence advance mode:** Sequence set advance is controlled by a source that can be selected. The available sources are automatic control by the camera (the "always active" setting), an input line or the "disabled" setting allowing sequence set advance only by software commands. The camera will cycle through the available sequence sets in ascending sequence set index number as frames are triggered. After one sequence set cycle is complete another one will start automatically. For more information, see Section 10.10.2 on [page 197](#).
- **Free selection sequence advance mode:** Sequence set advance by selecting sequence sets at will from the available sequence sets. The selection is controlled by the states of the input lines. For more information, see Section 10.10.3 on [page 216](#).

The regular cycling through the sequence sets according to the Auto or Controlled advance modes can be modified at any time during the cycling:

- a **restart** starts a new sequence set cycle before the previous cycle is completed. The restart can be controlled
  - by the states of an input line (controlled sequence advance only) or
  - by a software command
- a non-cyclical **advance** allows to skip a sequence set and will advance to the sequence set after the next. The non-cyclical advance can be controlled
  - by the states of an input line or
  - by a software command.

Advance or restart controlled by an input line are also called "synchronous advance" and "synchronous restart" because the checking of the states of an input line is always linked to a frame trigger signal.

Advance or restart controlled by a software command are also called "asynchronous advance" and "asynchronous restart" because they are not linked to a frame start trigger signal.



Synchronous advance and restart are part of the standard operation of the sequencer feature and should generally be used. Asynchronous advance and restart are not suitable for standard operation because of the associated delays:

The delay between sending a software command and it becoming effective will depend on the specific installation and the current load on the network. Accordingly, the number of image acquisitions that may occur between sending the software command and it becoming effective can not be predicted. Asynchronous advance and restart are therefore not suitable for real-time applications, they may, however, be useful for testing purposes.

We strongly recommend to **only** use synchronous advance and synchronous restart for real-time applications.



You can use the Sequence Set Index chunk feature to add a chunk to each acquired frame. The chunk contains the index number of the sequence set that was used for the frame acquisition. For more information about the Sequence set Index chunk, see the "Chunk Features" section.

## Using the Load Command

There is also the Sequence Set Load command that may be useful when working with the sequence sets for testing purposes. If you use the Sequence Set Selector parameter to select a sequence set and then you execute the Sequence Set Load command, the sequence parameter values in the active set will be replaced by the values stored in the selected sequence set.

This ability can be useful in two situations:

- If you simply want to see how the parameters currently stored in one of the sequence sets will affect camera operation, you can load the parameters from that sequence set into the active parameter set and see what happens.
- If you want to prepare a new sequence set and you know that an existing set is already close to what you will need, you can load the existing sequence set into the active set, make some small changes to the active set, and then save the active set as a new sequence set.

Make sure the sequencer feature is disabled before issuing the Sequence Set Load command.



Replacing the sequence parameter values in the active set via the Sequence Set Load command is associated with a delay between sending the software command and it becoming effective. The delay will depend on the specific installation and the current load on the network. Accordingly, the number of image acquisitions that may occur between sending the command and it becoming effective can not be predicted. The Sequence Set Load command is therefore not suitable for real-time applications, it may, however, be useful for testing purposes.

The following code snippet illustrates using the API to load the sequence parameter values from sequence set 0 into the active set:

```
// Select sequence set with index number 0
Camera.SequenceSetIndex.SetValue( 0 );
// Load the sequence parameter values from the sequence set into the
active set
Camera.SequenceSetLoad.Execute( );
```

You can also use the Basler pylon Viewer application to easily set the parameters.

## Use Case Diagrams Illustrating Sequencer Operation

The sections below explain the sequence advance modes in detail. Use case descriptions and diagrams are designed to illustrate how the sequence advance modes work in some common situations and with some common combinations of parameter settings.

These use cases do not represent every possible combination of the parameters associated with sequence advance mode operation. They are simply intended to aid you in developing an initial understanding of how the sequence advance modes work.

In each use case diagram, the black box in the upper left corner indicates how the parameters are set.



The use case diagrams are representational. They are not drawn to scale and are not designed to accurately describe precise camera timings.

### 10.10.1 Auto Sequence Advance Mode

When the auto sequence advance mode is selected the advance from one sequence set to the next occurs automatically as frame triggers are received. The advance proceeds in ascending sequence set index numbers and subject to the Sequence Set Executions parameter value. It specifies how many times each sequence set is consecutively used. After the sequence set with the highest index number was used as many times as specified by the Sequence Set Executions parameter value, the sequence set cycle starts again with sequence set 0.

The Sequence Set Total Number parameter specifies the total number of different sequence sets that are available and included within a sequence set cycle. The maximum number is 64.

#### 10.10.1.1 Operation

##### Operating the Sequencer

The following use case (see also Figure 46 on [page 193](#)) illustrates the operation of the sequencer in auto sequence advance mode. As images are captured continuously, the camera advances automatically with no action by the user from one sequence set to the next in ascending sequence set index numbers. The advance is also subject to the Sequence Set Executions parameter settings. After one sequence set cycle is complete, another one starts.

In this use case, the Sequence Set Total Number parameter was set to six. Accordingly, the available sequence set index numbers range from 0 through 5. The Sequence Set Executions parameter was set to 1 for sequence sets 0, 2, 3, and 4, to 2 for sequence set 5, and to 3 for sequence set 1. The frame start trigger is set for rising edge triggering.



Assuming that the camera is in the process of continuously capturing images, the sequencer feature operates as follows:

- When the sequencer feature becomes enabled, the sequence set cycle starts: The parameter values of the sequence set with sequence set index number 0 are loaded into the active set modifying the active set.

When a frame start trigger is received, sequence set 0 is used for the image acquisition.

- When the next frame start trigger is received, the camera checks the current Sequence Set Executions parameter value. Because the Sequence Set Executions parameter is set to 1 for sequence set 0, this sequence set is only used once and therefore the camera advances to the next sequence set: The parameter values of sequence set 1 are loaded into the active set and are used for the image acquisition.
  - When the next frame start trigger is received, the camera checks the current Sequence Set Executions parameter value. Because the Sequence Set Executions parameter is set to 3 for sequence set 1, this sequence set is used a second time: The parameter values of sequence set 1 are used for the image acquisition.
  - When the next frame start trigger is received, the camera checks the current Sequence Set Executions parameter value. Because the Sequence Set Executions parameter was set to 3 for sequence set 1, this sequence set is used a third time: The parameter values of sequence set 1 are used for the image acquisition.
  - When the next frame start trigger is received, the camera checks the current Sequence Set Executions parameter value. Because the Sequence Set Executions parameter is set to 3 for sequence set 1, this sequence set can not, after three uses, be used again in the current sequence set cycle. Therefore, the camera advances to the next sequence set: The parameter values of sequence set 2 are used for the image acquisition.
  - When the next frame start trigger is received, the camera checks the current Sequence Set Executions parameter value. Because the Sequence Set Executions parameter is set to 1 for sequence set 2, this sequence set is only used once and therefore the camera advances to the next sequence set: The parameter values of sequence set 3 are used for the image acquisition.
  - When the next frame start trigger is received, the camera checks the current Sequence Set Executions parameter value. Because the Sequence Set Executions parameter is set to 1 for sequence set 3, this sequence set is only used once and therefore the camera advances to the next sequence set: The parameter values of sequence set 4 are used for the image acquisition.
  - When the next frame start trigger is received, the camera checks the current Sequence Set Executions parameter value. Because the Sequence Set Executions parameter is set to 1 for sequence set 4, this sequence set is only used once and therefore the camera advances to the next sequence set: The parameter values of sequence set 5 are used for the image acquisition.
  - When the next frame start trigger is received, the camera checks the current Sequence Set Executions parameter value. Because the Sequence Set Executions parameter is set to 2 for sequence set 5, this sequence set is used a second time: The parameter values of sequence set 5 are used for the image acquisition.
- The camera has cycled once through the complete sequence set cycle.
- When the next frame start trigger is received, the camera checks the current Sequence Set Executions parameter value. Because the Sequence Set Executions parameter is set to 2 for sequence set 5, this sequence set can not, after two uses, be used again in the current

sequence set cycle. Therefore the camera advances to the next sequence set: The parameter values of sequence set 0 are used for the image acquisition.

Another sequence set cycle has started.

- The sequencer feature is disabled while frame exposure and readout are in progress. The complete frame is transmitted and the cycling through sequence sets is terminated. The sequencer parameter values in the active set return to the values that existed before the sequencer feature was enabled.

**Use Case 1:** Operation in auto sequence advance mode:  
Automatic cycling through the sequence set cycles with no action by the user. Enabling and disabling of the sequencer feature.

**Settings:** Sequence Set Total Number = 6  
Sequence Set Executions = 1 for sequence sets 0, 2, 3, and 4  
Sequence Set Executions = 2 for sequence set 5  
Sequence Set Executions = 3 for sequence set 1

Frame start trigger --> Set to rising edge triggering

- ▼ = camera selects a sequence set as the current sequence set (x) = count of frame start trigger
- 0 = current sequence set that is used for the image acquisition (the sequence set index number is indicated)
- = frame exposure and readout
- ⋮ = frame transmission

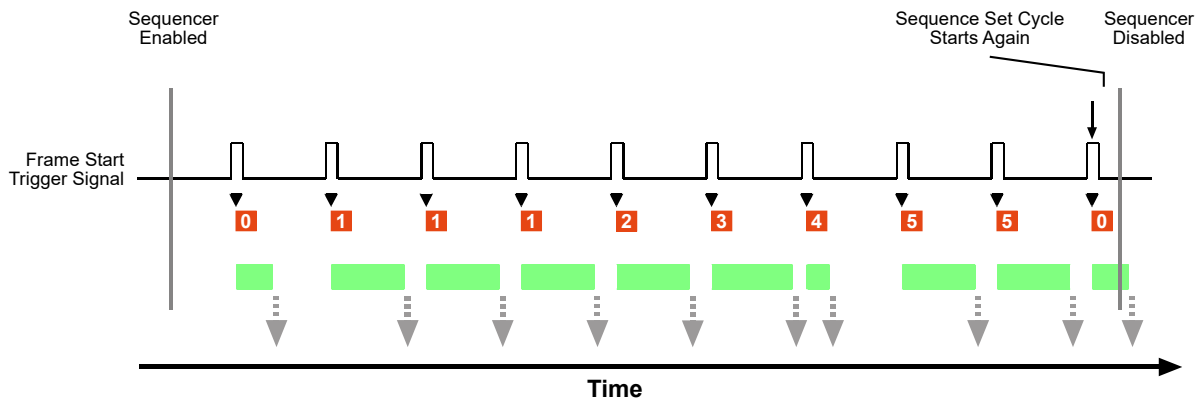

Fig. 46: Sequencer in Auto Sequence Advance Mode

## Operating the Sequencer Using Basler pylon

You can use the pylon API to set the parameters for operating the sequencer in Auto sequence advance mode from within your application software.

The following code snippet illustrates enabling the sequencer and disabling the sequencer. The example assumes that sequence sets were previously configured and are currently available in the camera's memory.

```
// Enable the sequencer feature
Camera.SequenceEnable.SetValue( true );

// Disable the sequencer feature
Camera.SequenceEnable.SetValue( false );
```

You can also use the Basler pylon Viewer application to easily set the parameters.

### 10.10.1.2 Configuration

#### Configuring Sequence Sets and Advance Control

Use the following procedure for populating sequence sets and making the related settings:

1. Make sure that the sequencer feature is disabled.
2. Set the Sequence Advance Mode parameter to Auto.
3. Set the Sequence Set Total Number parameter. The maximum number is 64.
4. Select a sequence set index number by setting the Sequence Set Index parameter. The available numbers range from 0 to 63.

When configuring sequence sets make sure to always use a continuous series of index numbers starting with index number 0 and ending with the Sequence Set Total Number parameter value minus one. For example, specifying a series of sequence sets only with index numbers 5, 6, and 8 is not allowed. If you did nonetheless, the not explicitly configured sequence sets would, within the scope of the sequence set total number, be populated by default parameter values.

5. Set up your first acquisition scenario (i.e., lighting, object positioning, etc.)
6. Adjust the camera parameters to get the best image quality with this scenario (you are adjusting all parameters in the active set).
7. Set the Sequence Set Executions parameter. The available numbers range from 1 to 256.
8. Execute the Sequence Set Store command to copy the sequence parameter values currently in the active set into the selected sequence set. Any already existing parameter values in the sequence set will be overwritten.
9. Repeat the above steps starting from step 4 for the other sequence sets.

## Configuring Sequence Sets and Advance Control Using Basler pylon

You can use the pylon API to set the parameters for configuring sequence sets from within your application software.

The following code snippet gives example settings. It illustrates using the API to set the auto sequence advance mode, set the total number of sequence sets to 2, set the numbers of consecutive sequence set executions and populate sequence sets 0 and 1 by storing the sequence parameter values from the active set in the sequence sets:

```
// Disable the sequencer feature
Camera.SequenceEnable.SetValue( false );

// Set the Auto sequence advance mode
Camera.SequenceAdvanceMode.SetValue( SequenceAdvanceMode_Auto );

// Set the total number of sequence sets
Camera.SequenceSetTotalNumber.SetValue( 2 );

// Select sequence set with index number 0
Camera.SequenceSetIndex.SetValue( 0 );

// Set up the first acquisition scenario (lighting, object position,
// etc.) and adjust the camera parameters for the best image quality.

// Set the number of sequence set uses
Camera.SequenceSetExecutions.SetValue( 1 );

// Store the sequence parameter values from the active set in the
// selected sequence set
Camera.SequenceSetStore.Execute( );

// Select sequence set with index number 1
Camera.SequenceSetIndex.SetValue( 1 );

// Set up the second acquisition scenario (lighting, object position,
// etc.) and adjust the camera parameters for the best image quality.

// Set the number of sequence set uses
Camera.SequenceSetExecutions.SetValue( 4 );
```

```
// Store the sequence parameter values from the active set in the  
// selected sequence set  
Camera.SequenceSetStore.Execute( );
```

You can also use the Basler pylon Viewer application to easily set the parameters.

## 10.10.2 Controlled Sequence Advance Mode

When the controlled sequence advance mode is selected the advance from one sequence set to the next proceeds in ascending sequence set index numbers according to the selected sequence control source:

- **Always Active:**  
The advance from one sequence set to the next proceeds automatically as frame triggers are received.
- **Input Line 1 or Input Line 2:**  
The advance from one sequence set to the next proceeds according to the states of the selected input line.
- **Disabled:**  
The advance from one sequence set to the next is only controlled by AsyncAdvance software commands.

The Sequence Set Total Number parameter specifies the total number of different sequence sets that are available and included within a sequence set cycle. The maximum number is 64.

### 10.10.2.1 Operation with the "Always Active" Sequence Control Source

#### Operating the Sequencer

When the Always Active sequence control source is selected the advance from one sequence set to the next proceeds automatically in ascending sequence set index numbers as frame start triggers are received.

The following use case (see also Figure 47) illustrates the operation of the sequencer in controlled sequence advance mode with Always Active selected as the sequence control source. As images are captured continuously, the camera advances automatically with no action by the user from one sequence set to the next in ascending sequence set index numbers. After one sequence set cycle is complete, another one starts.



This way of operating the sequencer feature is similar to operating it in auto sequence advance mode when each sequence set is used only once per sequence set cycle.

Here, however, the first sequence set used for image acquisition after the sequencer feature was enabled is sequence set 1 as opposed to sequence set 0 in auto sequence advance mode.

In this use case, the Sequence Set Total Number parameter is set to six. Accordingly, the available sequence set index numbers range from 0 through 5. The frame start trigger is set for rising edge triggering.

Assuming that the camera is in the process of continuously capturing images, the sequencer feature operates as follows:

- When the sequencer feature becomes enabled, the sequence set cycle starts: The parameter values of the sequence set with sequence set index number 0 are loaded into the active set modifying the active set.  
When a frame start trigger is received, the camera automatically advances to the next sequence set: The parameter values of sequence set 1 are used for the image acquisition.
- When the next frame start trigger is received, the camera advances to the next sequence set: The parameter values of sequence set 2 are used for the image acquisition.
- When the next frame start trigger is received, the camera advances to the next sequence set: The parameter values of sequence set 3 are used for the image acquisition.
- and so on. Note that the camera has cycled once through the complete sequence set cycle when sequence set 5 was used. With the next frame start trigger, a new sequence set cycle starts where sequence set 0 is used.
- After the sequencer feature is disabled, the cycling through sequence sets is terminated. The sequencer parameter values in the active set return to the values that existed before the sequencer feature was enabled.

**Use Case:** Operation in controlled sequence advance mode with Always Active as the sequence control source:  
Automatic cycling through the sequence set cycles with no action by the user. Enabling and disabling of the sequencer feature.

**Setting:** Sequence Set Total Number = 6

- ▼ = camera selects a sequence set as the current sequence set
- 0 = current sequence set that is used for the image acquisition (the sequence set index number is indicated)
- = frame exposure and readout
- ⋮ = frame transmission

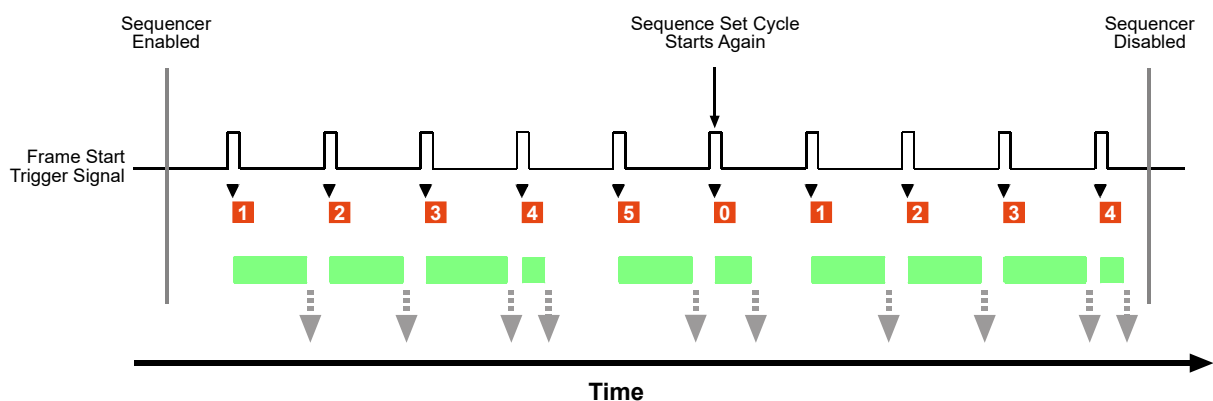

Fig. 47: Sequencer in Controlled Sequence Advance Mode with Always Active as the Sequence Control Source

## Synchronous Restart

You can restart the sequence cycle with input line 1 or input line 2 as the source for controlling sequence cycle restart.

In the following use case (see also Figure 48), the same settings were made as in the previous use case: The Sequence Set Total Number parameter was set to six. Accordingly, the available sequence set index numbers range from 0 through 5. The frame start trigger is set for rising edge triggering. In addition, Line 1 was selected as the source for controlling restart. Line 1 is not set for invert.

Assuming that the camera is in the process of continuously capturing images, the sequencer feature operates as follows:

- When the sequencer feature becomes enabled, the sequence set cycle starts: The parameter values of the sequence set with sequence set index number 0 are loaded into the active set modifying the active set.

When a frame start trigger is received, the camera automatically advances to the next sequence set: The parameter values of sequence set 1 are loaded into the active set and are used for the image acquisition.

- When the next frame start trigger is received, the camera advances to the next sequence set: The parameter values of sequence set 2 are used for the image acquisition.
- When the next frame start trigger is received, the camera advances to the next sequence set: The parameter values of sequence set 3 are used for the image acquisition.
- When the next frame start trigger is received, input line 1 is found to be high. Accordingly, another sequence set cycle is started and the parameter values of sequence set 0 are used for the image acquisition.

Note that the synchronous restart has priority here over the automatic sequence set advance that results from the Always Active sequence control source. Without the priority rule, sequence set 1 would be used.

Note that the state of input line 1 goes high well ahead of the frame start trigger.



To ensure reliable synchronous sequence set restart, allow the elapse of at least one microsecond between setting the state of the input line and the rise of the frame start trigger signal.

Also, maintain the state of the input line at least for one microsecond after the frame start trigger signal has risen.

Note also that the camera briefly exits the "waiting for frame start trigger" status while the input line changes its state. This happens when input line 1 changes its state before the fourth frame start trigger is received (see also Figure 48).





Make sure not to send a frame start trigger while the input line changes its state. During this period, the camera will not wait for a frame start trigger and any frame start trigger will be ignored.





Make sure to only send a frame start trigger when the camera is in "waiting for frame start trigger" status.

For information about possibilities of getting informed about the "waiting for frame start trigger" status, see the Acquisition Monitoring Tools section.

- When the next frame start trigger is received, the camera advances to the next sequence set: The parameter values of sequence set 1 are used for the image acquisition.
- When the next frame start trigger is received, input line 1 is found to be high. Accordingly, another sequence set cycle is started and the parameter values of sequence set 0 are used for the image acquisition. As explained above, synchronous restart has priority here over the automatic sequence set advance.
- When the next frame start triggers are received, the camera advances to the next sequence sets and uses them for image acquisition in accord with the Always Active sequence control source and as described in the previous use case.

**Use Case:** Operation in controlled sequence advance mode with Always Active as the sequence control source:  
Automatic cycling through the sequence set cycles with two synchronous restarts controlled by input line 1.

**Setting:** Sequence Set Total Number = 6  
Line 1 (not set for invert) is selected as the source for controlling restart

-  = camera is waiting for a frame start trigger
-  = camera selects a sequence set as the current sequence set
-  = current sequence set that is used for the image acquisition (the sequence set index number is indicated)
-  = frame exposure and readout
-  = frame transmission

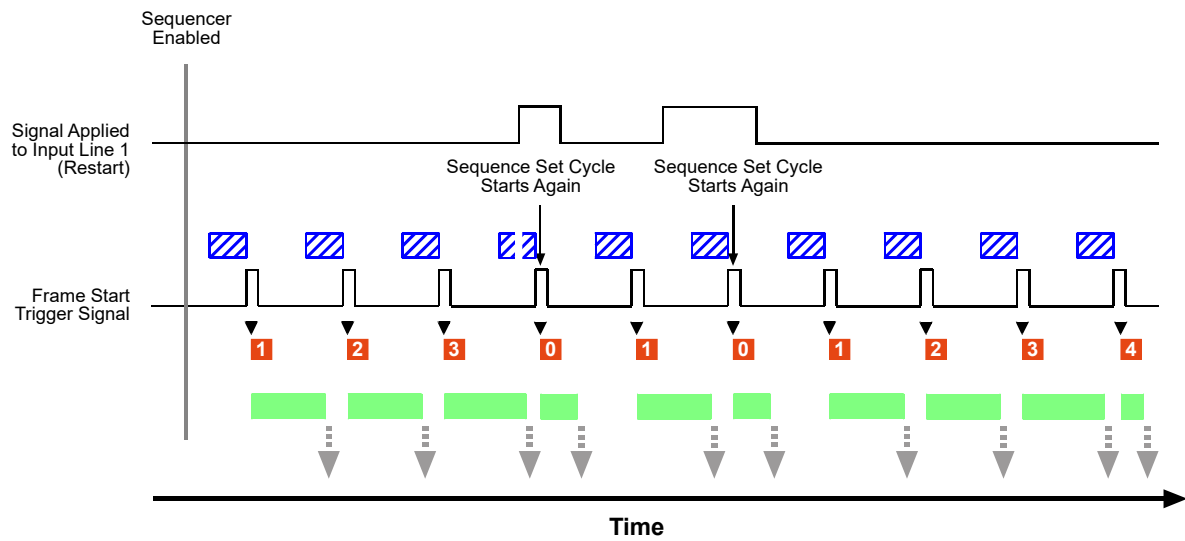

Fig. 48: Sequencer in Controlled Sequence Advance Mode with Always Active as the Sequence Control Source and Synchronous Restart Controlled by Line 1

## 10.10.2.2 Operation with an Input Line as Sequence Control Source

### Operating the Sequencer

When the Line 1 or Line 2 sequence control source is selected the advance from one sequence set to the next is controlled according to the states of input line 1 or input line 2. The advance proceeds in ascending sequence set index numbers as frame start triggers are received.



This section assumes that Line 1 is selected as the sequence control source. All explanations, however, apply equally well to Line 2 as the sequence control source.

The following use case (see also Figure 49) illustrates the operation of the sequencer in controlled sequence advance mode with Line 1 selected as the sequence control source. The camera advances from one sequence set to the next in ascending sequence set index numbers. After one sequence set cycle is complete, another one starts. The sequence set advance is controlled by the states of Line 1. Line 1 is not set for invert.

In this use case, the Sequence Set Total Number parameter was set to six. Accordingly, the available sequence set index numbers range from 0 through 5. The frame start trigger is set for rising edge triggering.

Assuming that the camera is in the process of continuously capturing images, the sequencer feature operates as follows:

- When the sequencer feature becomes enabled, the sequence set cycle starts: The parameter values of the sequence set with sequence set index number 0 are loaded into the active set modifying the active set.

When a frame start trigger is received, the camera checks the state of input line 1. Input line 1 is found to be low (the line status equals zero) and therefore no new sequence parameter values are loaded into the active set. The parameter values of sequence set 0 are used for the image acquisition.

- When the next frame start trigger is received, the camera checks the state of input line 1. Input line 1 is found to be high (the line status equals one) and therefore the parameter values of the next sequence set are loaded into the active set. The parameter values of sequence set 1 are used for the image acquisition.

Note that the state of input line 1 goes high well ahead of the frame start trigger.



To ensure reliable selection of a sequence set, allow the elapse of at least one microsecond between setting the states of the input lines and the rise of the frame start trigger signal.

Also, maintain the states of the input lines at least for one microsecond after the frame start trigger signal has risen.

Note also that the camera briefly exits the "waiting for frame start trigger" status while an input line changes its state. This happened when input line 1 changed its state before the second frame start trigger was received (see also Figure 49).



Make sure not to send a frame start trigger while the input line changes its state. During this period, the camera will not wait for a frame start trigger and any frame start trigger will be ignored.

Make sure to only send a frame start trigger when the camera is in "waiting for frame start trigger" status.

For information about possibilities of getting informed about the "waiting for frame trigger" status, see the Acquisiton Monitoring Tools section.

- When the next frame start trigger is received, the camera checks the state of input line 1. Input line 1 is found to be low and therefore no new sequence parameter values are loaded into the active set. The parameter values of sequence set 1 are used for the image acquisition.
- When the next frame start trigger is received, the camera checks the state of input line 1. Input line 1 is found to be low and therefore no new sequence parameter values are loaded into the active set. The parameter values of sequence set 1 are used for the image acquisition.
- When the next frame start trigger is received, the camera checks the state of input line 1. Input line 1 is found to be high and therefore the parameter values of the next sequence set are loaded into the active set. The parameter values of sequence set 2 are used for the image acquisition.
- When the next frame start trigger is received, the camera checks the state of input line 1. Input line 1 is found to be high and therefore the parameter values of the next sequence set are loaded into the active set. The parameter values of sequence set 3 are used for the image acquisition.
- When the next frame start trigger is received, the camera checks the state of input line 1. Input line 1 is found to be high and therefore the parameter values of the next sequence set are loaded into the active set. The parameter values of sequence set 4 are used for the image acquisition.
- When the next frame start trigger is received, the camera checks the state of input line 1. Input line 1 is found to be high and therefore the parameter values of the next sequence set are loaded into the active set. The parameter values of sequence set 5 are used for the image acquisition.
- When the next frame start trigger is received, the camera checks the state of input line 1. Input line 1 is found to be low and therefore no new sequence parameter values are loaded into the active set. The parameter values of sequence set 5 are used for the image acquisition.

The camera has cycled once through the complete sequence set cycle.





- When the next frame start trigger is received, the camera checks the state of input line 1. Input line 1 is found to be high and therefore the parameter values of the next sequence set are loaded into the active set. The parameter values of sequence set 0 are used for the image acquisition.

Another sequence set cycle is started.

- After frame exposure and readout are completed, the sequencer feature is disabled. The cycling through sequence sets is terminated. The sequencer parameter values in the active set return to the values that existed before the sequencer feature was enabled.

**Use Case:** Operation in controlled sequence advance mode with Line 1 as the sequence control source:  
Cycling through the sequence set cycles according to the states of input line 1 (not set for invert). Enabling and disabling of the sequencer feature.

**Setting:** Sequence Set Total Number = 6

-  = camera is waiting for a frame start trigger
-  = camera selects a sequence set as the current sequence set
-  = current sequence set that is used for the image acquisition (the sequence set index number is indicated)
-  = frame exposure and readout
-  = frame transmission

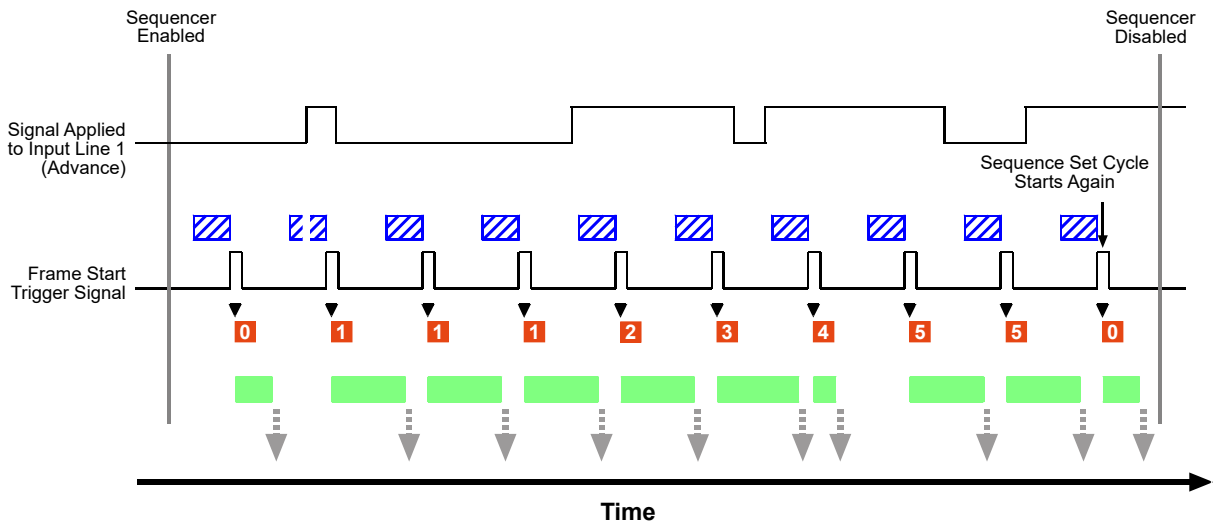

Fig. 49: Sequencer in Controlled Sequence Advance Mode with Line 1 as the Sequence Control Source

### Synchronous Restart

You can restart the sequence cycle by selecting the input line that is not used for sequence advance control as the source for controlling sequence cycle restart.

In the following use case (see also Figure 50), the same settings were made as in the previous use case: The Sequence Set Total Number parameter was set to six. Accordingly, the sequence set index numbers range from 0 through 5. The frame start trigger is set for rising edge triggering.

Line 1 is selected as the sequence control source for controlling sequence set advance. In addition, Line 2 is selected as the source for controlling sequence cycle restart. Both input lines are not set for invert.

Assuming that the camera is in the process of continuously capturing images, the sequencer feature operates as follows:

- When the sequencer feature becomes enabled, the sequence set cycle starts: The parameter values of the sequence set with sequence set index number 0 are loaded into the active set modifying the active set.

When a frame start trigger is received, the camera checks the states of input lines 2 and 1. Input line 2 is found to be low and therefore the sequence cycle is not restarted. Input line 1 is found to be low and therefore no new sequence parameter values are loaded into the active set. The parameter values of sequence set 0 are used for the image acquisition.

- When the next frame start trigger is received, the camera checks the states of input lines 2 and 1. Input line 2 is found to be low and therefore the sequence cycle is not restarted. Input line 1 is found to be high and therefore the parameter values of the next sequence set are loaded into the active set. The parameter values of sequence set 1 are used for the image acquisition.
- When the next frame start trigger is received, the camera checks the states of input lines 2 and 1. Input line 2 is found to be low and therefore the sequence cycle is not restarted. Input line 1 is found to be high and therefore the parameter values of the next sequence set are loaded into the active set. The parameter values of sequence set 2 are used for the image acquisition.
- When the next frame start trigger is received, the camera checks the states of input lines 2 and 1. Input line 2 is found to be high and therefore the sequence cycle is restarted. Input line 1 is found to be low but this has no significance: Synchronous restart has priority over the sequence set advance control. The parameter values of sequence set 0 are used for the image acquisition.

Another sequence set cycle has started.

Note that the state of input line 2 goes high well ahead of the frame start trigger.



To ensure reliable selection of a sequence set, allow the elapse of at least one microsecond between setting the states of the input lines and the rise of the frame start trigger signal.

Also, maintain the states of the input lines at least for one microsecond after the frame start trigger signal has risen.

Note also that the camera briefly exits the "waiting for frame start trigger" status while an input line changes its state. This happened, for example, when input line 2 changed its state before the fourth frame start trigger was received (see also Figure 50).



Make sure not to send a frame start trigger while an input line changes its state. During this period, the camera will not wait for a frame start trigger and any frame start trigger will be ignored.





Make sure to only send a frame start trigger when the camera is in "waiting for frame start trigger" status.

For information about possibilities of getting informed about the "waiting for frame trigger" status, see the Acquisition Monitoring Tools section.

- When the next frame start trigger is received, the camera checks the states of input lines 2 and 1. Input line 2 is found to be low and therefore the sequence cycle is not restarted. Input line 1 is found to be high and therefore the parameter values of the next sequence set are loaded into the active set. The parameter values of sequence set 1 are used for the image acquisition.
- When the next frame start trigger is received, the camera checks the states of input lines 2 and 1. Input line 2 is found to be low and therefore the sequence cycle is not restarted. Input line 1 is found to be high and therefore the parameter values of the next sequence set are loaded into the active set. The parameter values of sequence set 2 are used for the image acquisition.
- When the next frame start trigger is received, the camera checks the states of input lines 2 and 1. Input line 2 is found to be low and therefore the sequence cycle is not restarted. Input line 1 is found to be high and therefore the parameter values of the next sequence set are loaded into the active set. The parameter values of sequence set 3 are used for the image acquisition.
- When the next frame start trigger is received, the camera checks the states of input lines 2 and 1. Input line 2 is found to be high and therefore the sequence cycle is restarted. Input line 1 is found to be high but this has no significance: Synchronous restart has priority over the sequence set advance control. The parameter values of sequence set 0 are used for the image acquisition.  
Another sequence set cycle has started.
- When the next frame start trigger is received, the camera checks the states of input lines 2 and 1. Input line 2 is found to be low and therefore the sequence cycle is not restarted. Input line 1 is found to be high and therefore the parameter values of the next sequence set are loaded into the active set. The parameter values of sequence set 1 are used for the image acquisition.
- When the next frame start trigger is received, the camera checks the states of input lines 2 and 1. Input line 2 is found to be low and therefore the sequence cycle is not restarted. Input line 1 is found to be low and therefore no new sequence parameter values are loaded into the active set. The parameter values of sequence set 1 are used for the image acquisition.

**Use Case:** Operation in controlled sequence advance mode with Line 1 as the sequence control source:  
 Cycling through the sequence set cycles according to the states of input line 1 (not set for invert) with two synchronous restarts controlled by input line 2.

**Setting:** Sequence Set Total Number = 6  
 Line 2 (not set for invert) is selected as the source for controlling restart

-  = camera is waiting for a frame start trigger
-  = camera selects a sequence set as the current sequence set
-  = current sequence set that is used for the image acquisition (the sequence set index number is indicated)
-  = frame exposure and readout
-  = frame transmission

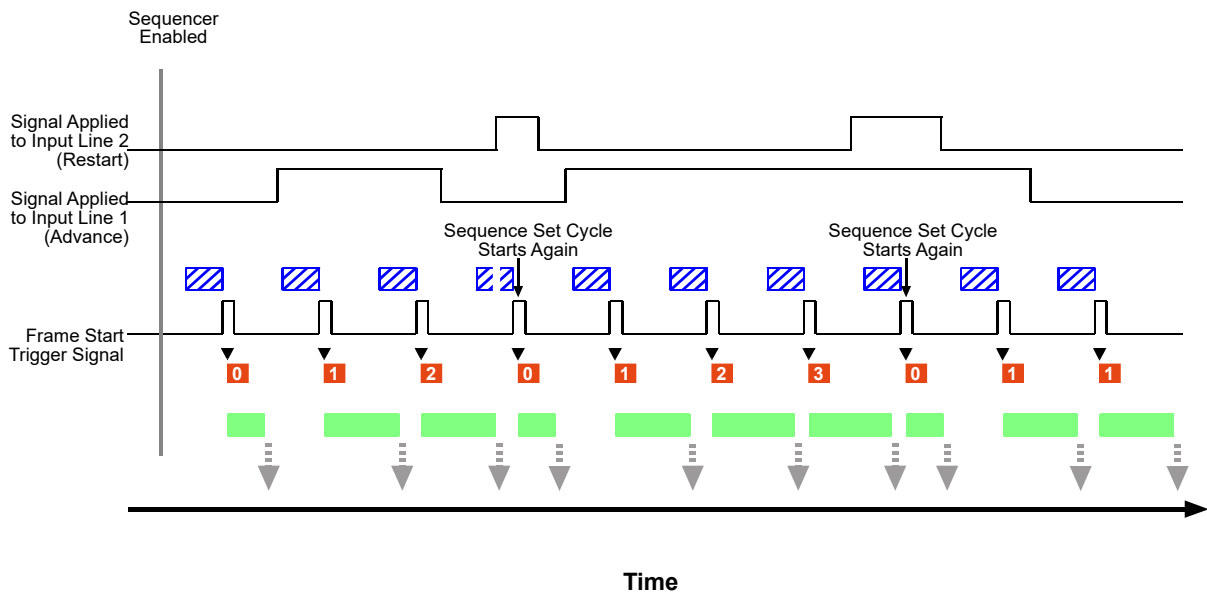

Fig. 50: Sequencer in Controlled Sequence Advance Mode with Line 1 as the Sequence Control Source and Synchronous Restart Controlled by Line 2



### 10.10.2.3 Operation with the "Disabled" Sequence Control Source

#### Operating the Sequencer

When the Disabled sequence control source is selected the advance from one sequence set to the next proceeds in ascending sequence set index numbers and is only possible by asynchronous advance.

Similarly, sequence set restart is only possible by asynchronous restart.



The delay between sending an AsyncAdvance or an AsyncRestart software command and it becoming effective will depend on the specific installation and the current load on the network. Accordingly, the number of image acquisitions that may occur between sending the software command and it becoming effective can not be predicted. Using the sequencer feature with Disabled sequence control source is therefore not suitable for real-time applications, it may, however, be useful for testing purposes.

We strongly recommend **not** to use the sequencer feature with Disabled sequence control source for real-time applications.

The following use case (see also Figure 51) illustrates the operation of the sequencer in controlled sequence advance mode with Disabled selected as the sequence control source. Sequence set advance proceeds in ascending sequence set index numbers subject to asynchronous advance commands. After one sequence set cycle is complete, another one starts. Sequence set cycle restarts are subject to asynchronous restart commands.

In this use case, the Sequence Set Total Number parameter was set to six. Accordingly, the available sequence set index numbers range from 0 through 5. The frame start trigger is set for rising edge triggering.

Assuming that the camera is in the process of continuously capturing images, the sequencer feature operates as follows:

- When the sequencer feature becomes enabled, the sequence set cycle starts: The parameter values of the sequence set with sequence set index number 0 are loaded into the active set modifying the active set.  
When a frame start trigger is received, the camera checks the active set and uses it for the image acquisition. The parameter values of sequence set 0 are used.
- An AsyncAdvance command is sent. After some delay, the parameter values of the next sequence set will be loaded into the active set. It is assumed here that the delay between sending the AsyncRestart command and it becoming effective will allow the acquisition of two more images.
- When the next frame start trigger is received, the camera checks the active set and uses it for the image acquisition. The parameter values of sequence set 0 are used.

The AsyncAdvance command has not yet become effective because of the assumed associated delay.

- When the next frame start trigger is received, the camera checks the active set and uses it for the image acquisition. The parameter values of sequence set 0 are used.

The AsyncAdvance command has not yet become effective because of the assumed associated delay.

- When the AsyncAdvance command becomes effective, the camera happens to be in "waiting for frame start trigger" status. The parameter values of the next sequence set, i.e. of sequence set 1, are loaded into the active set. Note that the camera briefly exits the "waiting for frame start trigger" status while the parameter values of sequence set 1 are loaded into the active set (see also Figure 51).



Make sure not to send a frame start trigger while the parameter values of a sequence set are loaded into the active set. During this period, the camera will not wait for a frame start trigger and any frame start trigger will be ignored.

Make sure to only send a frame start trigger when the camera is in "waiting for frame start trigger" status.

For information about possibilities of getting informed about the "waiting for frame start trigger" status, see the Acquisition Monitoring Tools section.

- When the next frame start trigger is received, the camera checks the active set and uses it for the image acquisition. The parameter values of sequence set 1 are used.
- When the next frame start trigger is received, the camera checks the active set and uses it for the image acquisition. The parameter values of sequence set 1 are used.
- When the next frame start trigger is received, the camera checks the active set and uses it for the image acquisition. The parameter values of sequence set 1 are used.
- An AsyncRestart command is sent. After some delay, the parameter values of sequence set 0 will be loaded into the active set. It is assumed here that the delay between sending the AsyncRestart command and it becoming effective will allow the acquisition of two more images.
- When the next frame start trigger is received, the camera checks the active set and uses it for the image acquisition. The parameter values of sequence set 1 are used.

The AsyncRestart command has not yet become effective because of the assumed associated delay.

- When the next frame start trigger is received, the camera checks the active set and uses it for the image acquisition. The parameter values of sequence set 1 are used.

The AsyncRestart command has not yet become effective because of the assumed associated delay.

- When the AsyncRestart command becomes effective, the camera happens to be in "waiting for frame start trigger" status. The parameter values of sequence set 0 are loaded into the active set. Note that the camera briefly exits the "waiting for frame start trigger" status while the parameter values of sequence set 1 are loaded into the active set (see also Figure 51).



Make sure not to send a frame start trigger while the parameter values of a sequence set are loaded into the active set. During this period, the camera will not wait for a frame start trigger and any frame start trigger will be ignored.









Make sure to only send a frame start trigger when the camera is in "waiting for frame start trigger" status.

For information about possibilities of getting informed about the "waiting for frame start trigger" status, see the Acquisition Monitoring Tools section.

- When the next frame start trigger is received, the camera checks the active set and uses it for the image acquisition. The parameter values of sequence set 0 are used.  
Another sequence set cycle has started
- When the next frame start trigger is received, the camera checks the active set and uses it for the image acquisition. The parameter values of sequence set 0 are used.
- While frame exposure and readout are in progress, the sequencer feature is disabled. The complete frame is transmitted and the cycling through sequence sets is terminated. The sequencer parameter values in the active set return to the values that existed before the sequencer feature was enabled.

**Use Case:** Operation in controlled sequence advance mode with Disabled sequence control source:  
 Cycling through the sequence set cycles only due to one asynchronous advance and one asynchronous restart. Enabling and disabling of the sequencer feature.

**Setting:** Sequence Set Total Number = 6

-  = asynchronous advance (AsyncAdvance command)
-  = delay between sending the advance command and it becoming effective
-  = asynchronous restart (AsyncRestart command)
-  = delay between sending the restart command and it becoming effective
-  = camera is waiting for a frame start trigger
-  = camera selects a sequence set as the current sequence set
-  = current sequence set that is used for the image acquisition (the sequence set index number is indicated)
-  = frame exposure and readout
-  = frame transmission

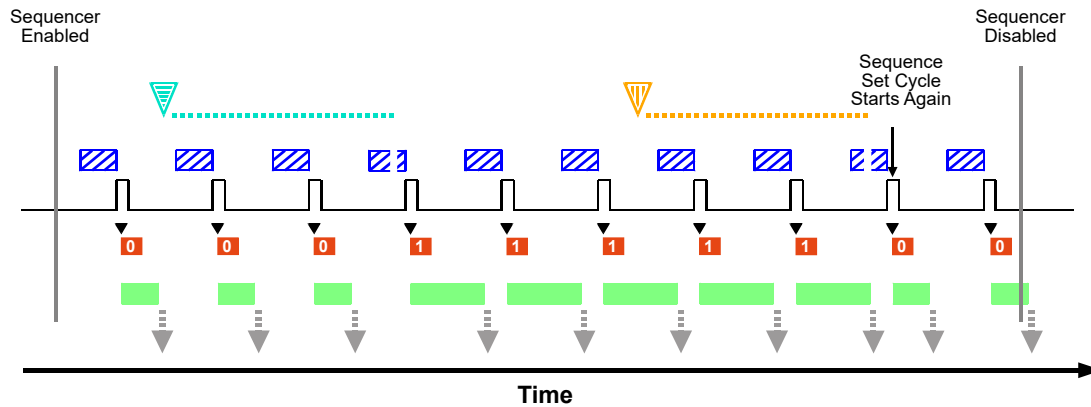

Fig. 51: Sequencer in Controlled Sequence Advance Mode with Disabled as the Sequence Control Source and Asynchronous Advance and Restart

## Operating the Sequencer Using Basler pylon

You can use the pylon API to set the parameters for operating the sequencer in Controlled sequence advance mode from within your application software.

The following code snippet illustrates enabling and disabling the sequencer. The example assumes that sequence sets were previously configured and are currently available in the camera's memory.

```
// Enable the sequencer feature
Camera.SequenceEnable.SetValue( true );

// Disable the sequencer feature
Camera.SequenceEnable.SetValue( false );
```

You can also use the Basler pylon Viewer application to easily set the parameters.

### 10.10.2.4 Configuration

#### Configuring Sequence Sets and Advance Control

Use the following procedure for populating sequence sets and setting the sources for sequence set advance and sequence cycle restart:

- Make sure that the sequencer feature is disabled.
- Set the Sequence Advance mode to Controlled.
- Set the Sequence Set Total Number parameter. The maximum number is 64.
- Set the Sequence Control Selector parameter to Advance to configure sequence set advance.
- Set the Sequence Control Source parameter to specify the source that will control synchronous sequence set advance. Note that the same source will apply to all sequence sets available at the same time in the camera.

The following sources are available:

- Always Active
- Line 1:
- Line 2:
- Disabled
- Set the Sequence Control Selector parameter to Restart to configure sequence set cycle restart.
- Set the Sequence Control Source parameter to specify the source for restart.



Never choose the same source for sequence set advance and sequence set cycle restart, with one exception:

If you want to only use asynchronous advance and restart, choose Disabled as the source for advance and restart.

The following sources are available:

- Line 1:
  - Line 2:
  - Disabled
- Select a sequence set index number by setting the Sequence Set Index parameter. The available numbers range from 0 to 63.  
When selecting index numbers for configuring, make sure to always start a sequence with 0 and to only set a continuous series of index numbers. For example, specifying a sequence of sets only with index numbers 5, 6, and 8 is therefore not allowed. If you did nonetheless, the not explicitly configured sequence sets would - within the scope of the sequence set total number - be populated by default parameter values.
  - Set up your first acquisition scenario (i.e., lighting, object positioning, etc.)
  - Adjust the camera parameters to get the best image quality with this scenario (you are adjusting the parameters in the active set).
  - Execute the Sequence Set Store command to copy the sequence parameter values currently in the active set into the selected sequence set. (Any existing parameter values in the sequence set will be overwritten.)
  - Repeat the above steps for the other sequence sets.

For information about setting the input line for invert, see Section 6.1.4 on [page 44](#).

## Configuring Sequence Sets and Advance Control Using Basler pylon

You can use the pylon API to set the parameters for configuring sequence sets from within your application software.

The following code snippet gives example settings. It illustrates using the API to set the controlled sequence advance mode. In the example, Line 1 is set as the sequence control source for synchronous sequence set advance, Disabled is set as the sequence control source to allow asynchronous sequence cycle reset, the total number of sequence sets is set to 2, sequence sets 0 and 1 are populated by storing the sequence parameter values from the active set in the sequence sets, and to enable the sequencer feature :

```
// Disable the sequencer feature  
Camera.SequenceEnable.SetValue( false );
```

```
// Set the Controlled sequence advance mode and set line 1 as the
// sequence control source for synchronous sequence set advance
Camera.SequenceAdvanceMode.SetValue( SequenceAdvanceMode_Controlled
);
Camera.SequenceControlSelector.SetValue(
SequenceControlSelector_Advance );
Camera.SequenceControlSource.SetValue( SequenceControlSource_Line1 );

// Set Disabled as the source because synchronous sequence set cycle
// restart will not be used
Camera.SequenceControlSelector.SetValue(
SequenceControlSelector_Restart );
Camera.SequenceControlSource.SetValue( SequenceControlSource_Disabled
);

// Set the total number of sequence sets
Camera.SequenceSetTotalNumber.SetValue( 2 );

// Select sequence set with index number 0
Camera.SequenceSetIndex.SetValue( 0 );

// Set up the first acquisition scenario (lighting, object position,
// etc.) and adjust the camera parameters for the best image quality.

// Store the sequence parameter values from the active set in the
// selected sequence set
Camera.SequenceSetStore.Execute( );

// Select sequence set with index number 1
Camera.SequenceSetIndex.SetValue( 1 );

// Set up the second acquisition scenario (lighting, object position,
// etc.) and adjust the camera parameters for the best image quality.

// Store the sequence parameter values from the active set in the
// selected sequence set
Camera.SequenceSetStore.Execute( );

// Enable the sequencer feature
Camera.SequenceEnable.SetValue( true );
```

The following code snippet illustrates using the API to load the sequence parameter values from sequence set 0 into the active set:

```
// Select sequence set with index number 0
Camera.SequenceSetIndex.SetValue( 0 );
// Load the sequence parameter values from the sequence set into the
// active set
Camera.SequenceSetLoad.Execute( );
```

You can also use the Basler pylon Viewer application to easily set the parameters.



## 10.10.3 Free Selection Sequence Advance Mode

When the free selection sequence advance mode is selected the advance from one sequence set to the next as frame start triggers are received does not adhere to a specific preset sequence: The sequence sets can be selected at will using the states of input lines: The states of the input lines set the sequence set addresses. These correspond to the sequence set index numbers and accordingly, the related sequence set is selected. For details about selecting sequence sets via the sequence set address, see the "Selecting Sequence Sets" section.

The states of two input lines are checked if more than two sequence sets are available. The states of one input line is checked when only two sequence sets are available.

The Sequence Set Total Number parameter specifies the total number of different sequence sets that are available. The maximum number is 4.

### 10.10.3.1 Operation

#### Operating the Sequencer

The following use case (see also Figure 52) illustrates the operation of the sequencer in free selection sequence advance mode.

In this use case, the Sequence Set Total Number parameter was set to four. Accordingly, the sequence set index numbers range from 0 through 3. Input line 1 sets bit 0 of the sequence set address. Input line 2 sets bit 1 of the sequence set address. Both input lines are not set for invert. The frame start trigger is set for rising edge triggering.

Assuming that the camera is in the process of continuously capturing images, the sequencer feature operates as follows:

- When the sequencer feature becomes enabled and a frame start trigger is received, the camera checks the states of input lines 1 and 2. Input line 1 is found to be high and input line 2 is found to be low. This corresponds to the address of sequence set 1. Accordingly, sequence set 1 is selected. Its parameter values are loaded into the active set and are used for the image acquisition.

Note that the state of input line 1 goes high well ahead of the frame start trigger.



To ensure reliable selection of a sequence set, allow the elapse of at least one microsecond between setting the states of the input lines and the rise of the frame start trigger signal.

Also, maintain the states of the input lines at least for one microsecond after the frame start trigger signal has risen.

Note also that the camera briefly exits the "waiting for frame start trigger" status while an input line changes its state. This happens, for example, when input line 1 changes its state before the first frame start trigger is received (see also Figure 52).



Make sure not to send a frame start trigger while an input line changes its state. During this period, the camera will not wait for a frame start trigger and any frame start trigger will be ignored.





Make sure to only send a frame start trigger when the camera is in "waiting for frame start trigger" status.

For information about possibilities of getting informed about the "waiting for frame trigger" status, see the Acquisition Monitoring Tools section.

- When the next frame start trigger is received, the camera checks the states of input lines 1 and 2. Because the states have not changed the parameter values of sequence set 1 are used for the image acquisition.
- When the next frame start trigger is received, the camera checks the states of input lines 1 and 2. The states of both input lines are found to be low. This corresponds to the address of sequence set 0. Accordingly, sequence set 0 is selected. The parameter values of sequence set 0 are used for the image acquisition.
- When the next frame start trigger is received, the camera checks the states of input lines 1 and 2. Input line 1 is found to be low and input line 2 is found to be high. This corresponds to the address of sequence set 2. Accordingly, sequence set 2 is selected. The parameter values of sequence set 0 are used for the image acquisition.
- The sequence sets for the next five frame start triggers are selected and used according to the scheme that applied to the preceding frame start triggers.
- While frame exposure and readout for the fifth frame start trigger are in progress, the sequencer feature is disabled. The complete frame is transmitted. The sequencer parameter values in the active set return to the values that existed before the sequencer feature was enabled.

**Use Case:** Operation in free selection sequence advance mode.  
Sequence sets are selected at will. The selection is controlled by the states of the input lines.

**Settings:** Sequence Set Total Number = 4  
Input line 1 (not set for invert) sets bit 0 of the sequence set address.  
Input line 2 (not set for invert) sets bit 1 of the sequence set address.

-  = camera is waiting for a frame start trigger
-  = camera selects a sequence set as the current sequence set
-  = current sequence set that is used for the image acquisition (the sequence set index number is indicated)
-  = frame exposure and readout
-  = frame transmission

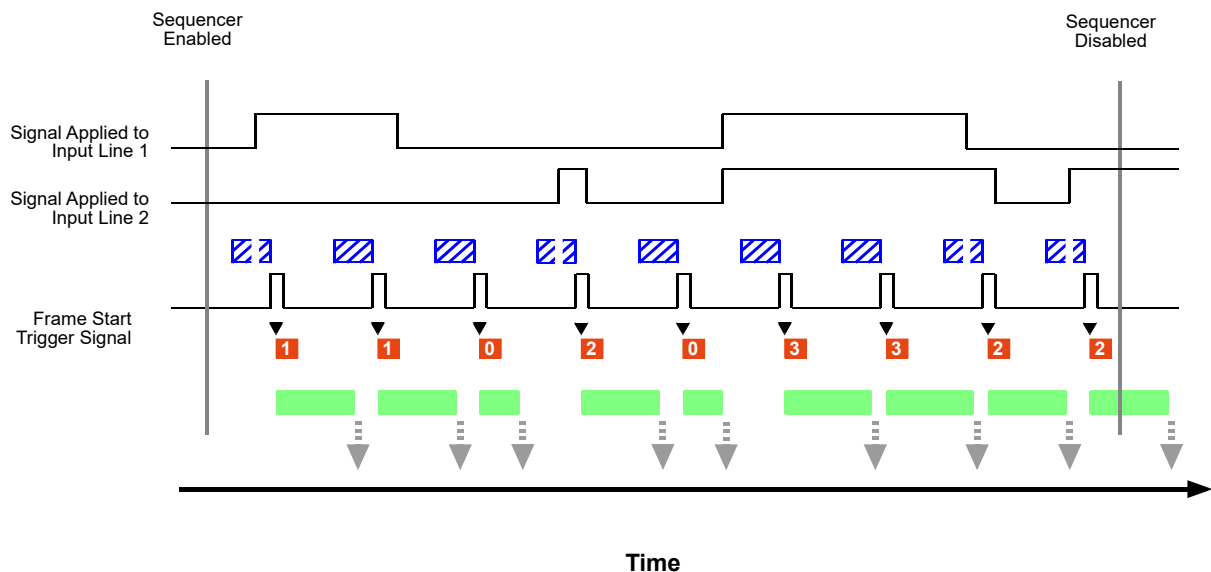

Fig. 52: Sequencer in Free Selection Mode

## Operating the Sequencer Using Basler pylon

You can use the pylon API to set the parameters for operating the sequencer in Free Selection sequence advance mode from within your application software.

The following code snippet illustrates enabling and disabling the sequencer. The example assumes that sequence sets were previously configured and are currently available in the camera's memory.

```
// Enable the sequencer feature
Camera.SequenceEnable.SetValue( true );
```

```
// Disable the sequencer feature
Camera.SequenceEnable.SetValue( false );
```

You can also use the Basler pylon Viewer application to easily set the parameters.

## Selecting Sequence Sets

Each sequence set is identified by a sequence set index number, starting from zero. The states of the input lines select between the sequence sets by setting the (big endian) sequence set addresses. The addresses are simply the binary expressions of the sequence set index numbers. A maximum of four sequence sets can be used:

Sequence Set Address		Related Sequence Set
Bit 1	Bit 0	
0	0	Sequence Set 0
0	1	Sequence Set 1
1	0	Sequence Set 2
1	1	Sequence Set 3

Table 12: Sequence Set Addresses and Related Sequence Sets

The Sequence Set Total Number parameter specifies the total number of sequence sets that will be available. The parameter also specifies the length of the settable sequence set address.

- If the Sequence Set Total Number parameter is set to two:  
Bit 0 of the binary sequence set index number (see Table 12) can be set. When the bit is set to 0, sequence set 0 will be selected and when the bit is set to 1, sequence set 1 will be selected (see Table 12).

You can use the states of either input line 1 or input line 2 to set bit 0.

- If the input line is not set for invert the high state of the input line will set bit 0 to 1 and the low state will set bit 0 to 0.
- If the input line is set for invert the low state of the input line will set bit 0 to 1 and the high state will set bit 0 to 0.
- If the Sequence Set Total Number parameter is set to higher than two:  
Bits 1 and 0 of the binary sequence set index number (see Table 12) can be set. When e.g. bit 0 is set to 0 and bit 1 is set to 1, sequence set 2 will be selected (see Table 12)

You can use the states of input line 1 to set bit 0 and the states of input line 2 to set bit 1 or vice versa.

- If the input lines are not set for invert the high states of the input lines will set the bits to 1 and the low states will set the bits to 0.
- If the input lines are set for invert the low states of the input lines will set the bits to 1 and the high states will set the bits to 0.

For information about setting an input line for invert, see Section 6.1.4 on [page 44](#).

## 10.10.3.2 Configuration

### Configuring Sequence Sets and Advance Control

Use the following procedure for populating sequence sets and setting the source for sequence set advance:

1. Make sure that the sequencer feature is disabled.
2. Set the Sequence Advance Mode parameter to Free Selection.
3. Set the Sequence Set Total Number parameter. The maximum number is 4.
4. Select the sequence set address bits and set the input lines that will act as the control sources:
  - If the Set Total Number parameter was set to two:
    - a. Bit 0 will be selected by default as the sequence set address bit. Set input line 1 or input line 2 as the control source for setting bit 0.
  - If the Set Total Number parameter was set to higher than two:
    - a. Select bit 0 of the sequence set address bit.
    - b. Set input line 1 or input line 2 as the control source for setting bit 0.
    - c. Select bit 1 of the sequence set address bit.
    - d. Set the input line as the control source for setting bit 1: Chose the input line not used for setting bit 0.
5. Use the Sequence Set Index parameter to select a sequence set index number for the sequence set currently being populated. The available numbers are 0 through 3.
6. Set up your first acquisition scenario (i.e., lighting, object positioning, etc.)
7. Adjust the camera parameters to get the best image quality with this scenario (you are adjusting the parameters in the active set).
8. Execute the Sequence Set Store command to copy the sequence parameter values currently in the active set into the selected sequence set. (Any existing parameter values in the sequence set will be overwritten.)
9. Repeat the above steps for the other sequence sets, starting from step 5.

### Configuring Sequence Sets and Advance Control Using Basler pylon

You can use the pylon API to set the parameters for configuring sequence sets from within your application software and make settings for their selection when images are acquired.

The following code snippet gives example settings. It illustrates using the API to set the free selection sequence advance mode with line 1 as the control source for bit 0 and line 2 as the control source for bit 1 of the sequence set address, set the total number of sequence sets to 3, and populate sequence sets 0 through 2 by storing the sequence parameter values from the active set in the sequence sets:

```
// Disable the sequencer feature
Camera.SequenceEnable.SetValue( false );
```

```
// Set the Free Selection sequence advance mode
Camera.SequenceAdvanceMode.SetValue(
SequenceAdvanceMode_FreeSelection );

// Set the total number of sequence sets
Camera.SequenceSetTotalNumber.SetValue(3);

// Set line 1 as the control source for setting sequence set
// address bit 0
Camera.SequenceAddressBitSelector.SetValue(
SequenceAddressBitSelector_Bit0 );
Camera.SequenceAddressBitSource.SetValue(
SequenceAddressBitSource_Line1 );

// Set line 2 as the control source for setting sequence set
// address bit 1
Camera.SequenceAddressBitSelector.SetValue(
SequenceAddressBitSelector_Bit1 );
Camera.SequenceAddressBitSource.SetValue(
SequenceAddressBitSource_Line2 );

// Select sequence set with index number 0
Camera.SequenceSetIndex.SetValue( 0 );

// Set up the first acquisition scenario (lighting, object position,
// etc.) and adjust the camera parameters for the best image quality
// Store the sequence parameter values from the active set in the
// selected sequence set
Camera.SequenceSetStore.Execute( );

// Select sequence set with index number 1
Camera.SequenceSetIndex.SetValue( 1 );

// Set up the second acquisition scenario (lighting, object position,
// etc.) and adjust the camera parameters for the best image quality.

// Store the sequence parameter values from the active set in the
// selected sequence set
Camera.SequenceSetStore.Execute( );

// Select sequence set with index number 2
Camera.SequenceSetIndex.SetValue( 2 );
```

```
// Set up the third acquisition scenario (lighting, object position,  
etc.) and adjust the camera parameters for the best image quality.
```

```
// Store the sequence parameter values from the active set in the  
// selected sequence set
```

```
Camera.SequenceSetStore.Execute( );
```

You can also use the Basler pylon Viewer application to easily set the parameters.

## 10.11 Binning



The binning feature is only available on the monochrome cameras.

Binning increases the camera's response to light by summing the charges from adjacent pixels into one pixel. Two types of binning are available: vertical binning and horizontal binning.

With vertical binning, adjacent pixels from 2 lines, 3 lines, or a maximum of 4 lines in the imaging sensor array are summed and are reported out of the camera as a single pixel. Figure 53 illustrates vertical binning.

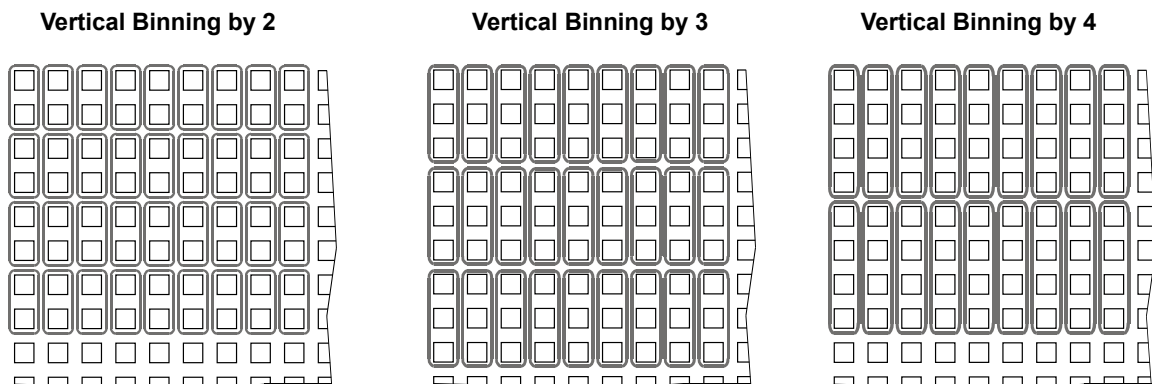

Fig. 53: Vertical Binning

With horizontal binning, adjacent pixels from 2 columns, 3 columns, or a maximum of 4 columns are summed and are reported out of the camera as a single pixel. Figure 54 illustrates horizontal binning.



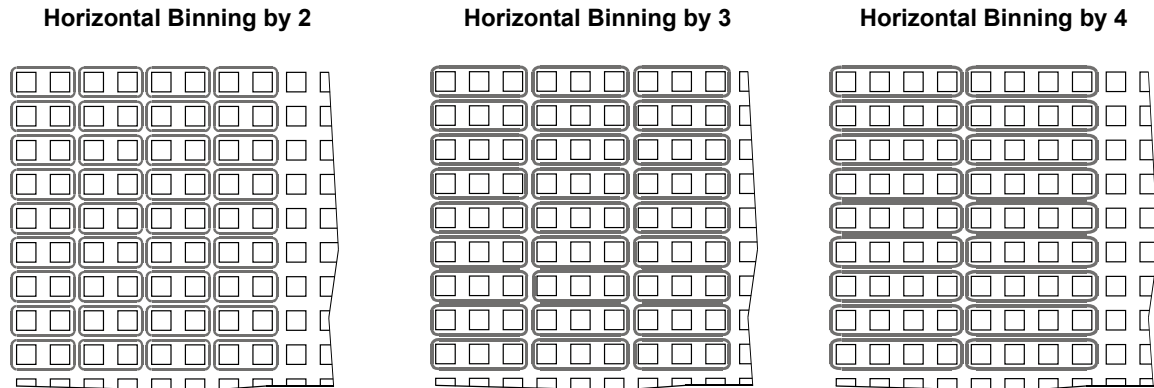

Fig. 54: Horizontal Binning

You can combine vertical and horizontal binning. This, however, may cause objects to appear distorted in the image. For more information on possible image distortion due to combined vertical and horizontal binning, see the next section.

## Setting Binning

You can enable vertical binning by setting the Binning Vertical parameter. Setting the parameter's value to 2, 3, or 4 enables vertical binning by 2, vertical binning by 3, or vertical binning by 4 respectively. Setting the parameter's value to 1 disables vertical binning.

You can enable horizontal binning by setting the Binning Horizontal parameter. Setting the parameter's value to 2, 3, or 4 enables horizontal binning by 2, horizontal binning by 3, or horizontal binning by 4 respectively. Setting the parameter's value to 1 disables horizontal binning.

You can use the pylon API to set the Binning Vertical or the Binning Horizontal parameter value from within your application software. The following code snippet illustrates using the API to set the parameter values:

```
// Enable vertical binning by 2
Camera.BinningVertical.SetValue( 2 );

// Enable horizontal binning by 4
Camera.BinningHorizontal.SetValue( 4 );

// Disable vertical and horizontal binning
Camera.BinningVertical.SetValue( 1 );
Camera.BinningHorizontal.SetValue( 1 );
```

You can also use the Basler pylon Viewer application to easily set the parameters.

For more information about the pylon API and the pylon Viewer, see Section 3 on [page 21](#).

## 10.11.1 Considerations When Using Binning

### Increased Response to Light

Using binning can greatly increase the camera's response to light. When binning is enabled, acquired images may look overexposed. If this is the case, you can reduce the lens aperture, reduce the intensity of your illumination, reduce the camera's exposure time setting, or reduce the camera's gain setting.

### Reduced Resolution

Using binning effectively reduces the resolution of the camera's imaging sensor. For example, the sensor in the avA1000-100gm camera has a maximum nominal resolution of 1024 (H) x 1024 (V) pixels. If you set this camera to use horizontal binning by 3 and vertical binning by 3, the effective maximum resolution of the sensor is reduced to 341 (H) by 341 (V). (Note that the 1024 pixel dimensions of the sensor are not evenly divisible by 3, so we rounded down to the nearest whole number.)

### Possible Image Distortion

Objects will only appear undistorted in the image if the numbers of binned lines and columns are equal. With all other combinations, the imaged objects will appear distorted. If, for example, vertical binning by 2 is combined with horizontal binning by 4 the widths of the imaged objects will appear shrunken by a factor of 2 compared to the heights.

If you want to preserve the aspect ratios of imaged objects when using binning, you must use vertical and horizontal binning where equal numbers of lines and columns are binned, e.g. vertical binning by 3 combined with horizontal binning by 3.

### Binning's Effect on AOI Settings

When you have the camera set to use binning, keep in mind that the settings for your area of interest (AOI) will refer to the binned lines and columns in the sensor and not to the physical lines in the sensor as they normally would. Another way to think of this is by using the concept of a "virtual sensor." For example, assume that you are using an avA1000-100gm camera set for 3 by 3 binning as described above. In this case, you would act as if you were actually working with a 341 column by 341 line sensor when setting your AOI parameters. The maximum AOI width would be 341 and the maximum AOI height would be 341. When you set the Width for the AOI, you will be setting this value in terms of virtual sensor columns. And when you set the Height for the AOI, you will be setting this value in terms of virtual sensor lines.

For more information about the area of interest (AOI) feature, see Section 10.17 on [page 243](#).

## **Binning's Effect on the Maximum Allowed Frame Rate**

Using vertical binning will increase the camera's maximum allowed frame rate.

For more information about determining the camera maximum allowed frame rate, see Section 7.9 on [page 93](#).

## 10.12 Mirror Imaging

The camera's reverse X and reverse Y functions let you flip the captured images horizontally and/or vertically before they are transmitted from the camera.

Note that the reverse X and reverse Y functions may both be enabled at the same time if so desired.

### 10.12.1 Reverse X

The reverse X feature is a horizontal mirror image feature. When the reverse X feature is enabled, the pixel values for each line in a captured image will be swapped end-for-end about the line's center. This means that for each line, the value of the first pixel in the line will be swapped with the value of the last pixel, the value of the second pixel in the line will be swapped with the value of the next-to-last pixel, and so on.

Figure 55 shows a normal image on the left and an image captured with reverse X enabled on the right.

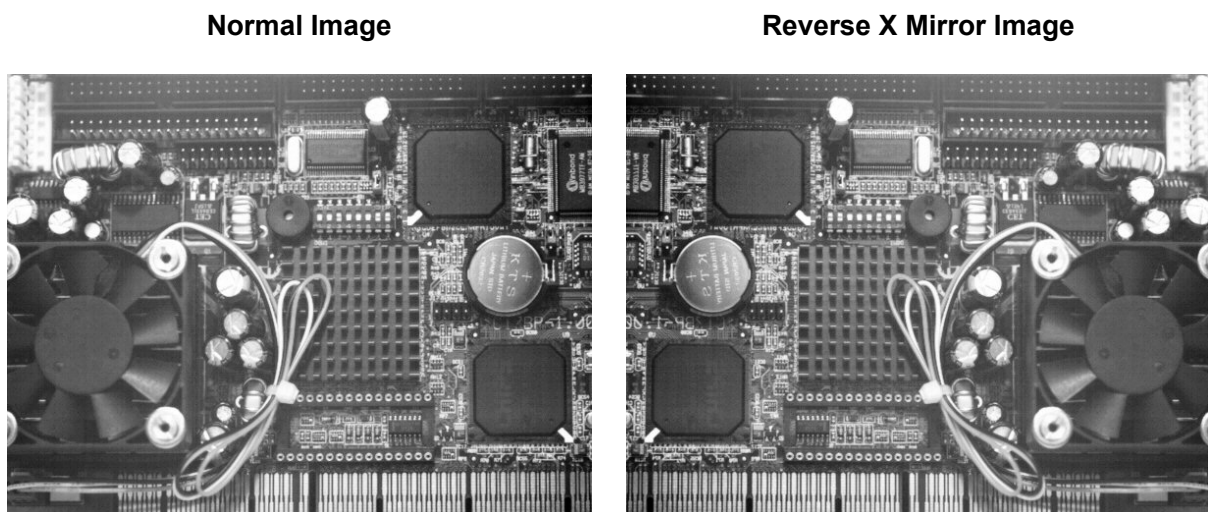

Fig. 55: Reverse X Mirror Imaging



On color models of the camera, when either the reverse X feature or the reverse Y feature or both are used, the alignment of the color filter to the image remains Bayer GB. The camera includes a mechanism that keeps the filter alignment constant when these features are used. For more information about the color filter, see Section 8.1 on [page 104](#).

## The Effect of Reverse X on the Auto Function AOIs

If you are using the camera's auto functions, you should be aware of the effect that using the reverse X feature will have on the auto function AOIs. When reverse X is used, the position of the auto function AOIs relative to the sensor remains the same. As a consequence, each auto function AOI will include a different portion of the captured image depending on whether or not the reverse X feature is enabled. Figure 56 shows the effect of that reverse X mirroring will have on the auto function AOIs.

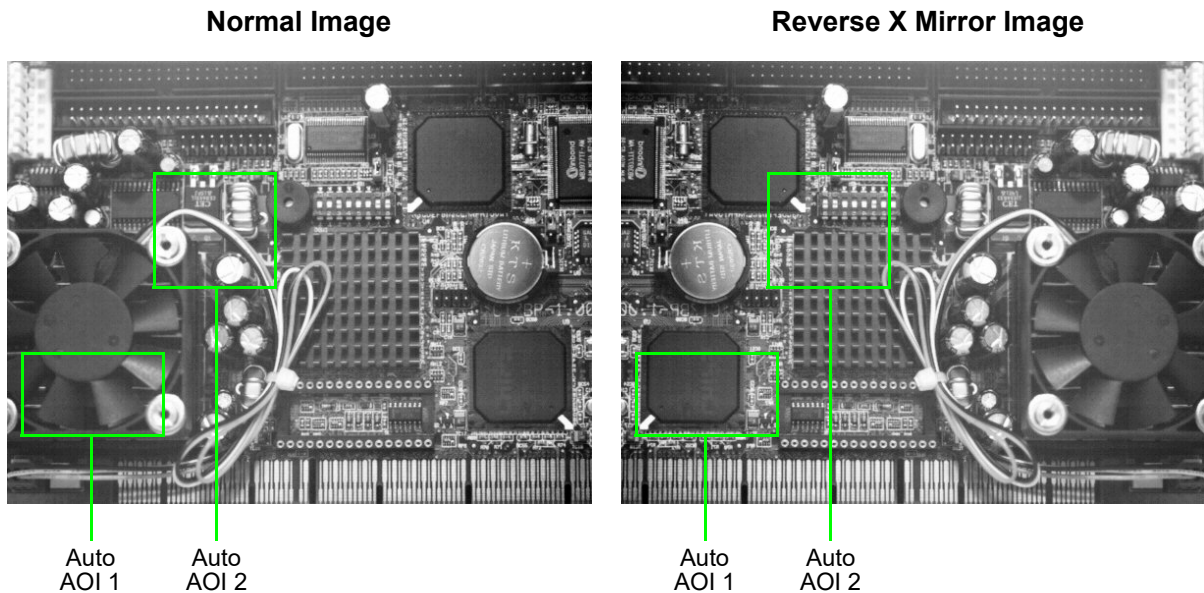

Fig. 56: Using Reverse X Mirror Imaging with Auto Functions Enabled

For more information about auto functions and auto function AOIs, see Section 10.7 on [page 164](#).

## 10.12.2 Reverse Y

The reverse Y feature is a vertical mirror image feature. When the reverse Y feature is enabled, the lines in a captured image will be swapped top-to-bottom. This means that the top line in the image will be swapped with the bottom line, the next-to-top line will be swapped with the next-to-bottom line, and so on.

Figure 55 shows a normal image on the left and an image captured with reverse Y enabled on the right.

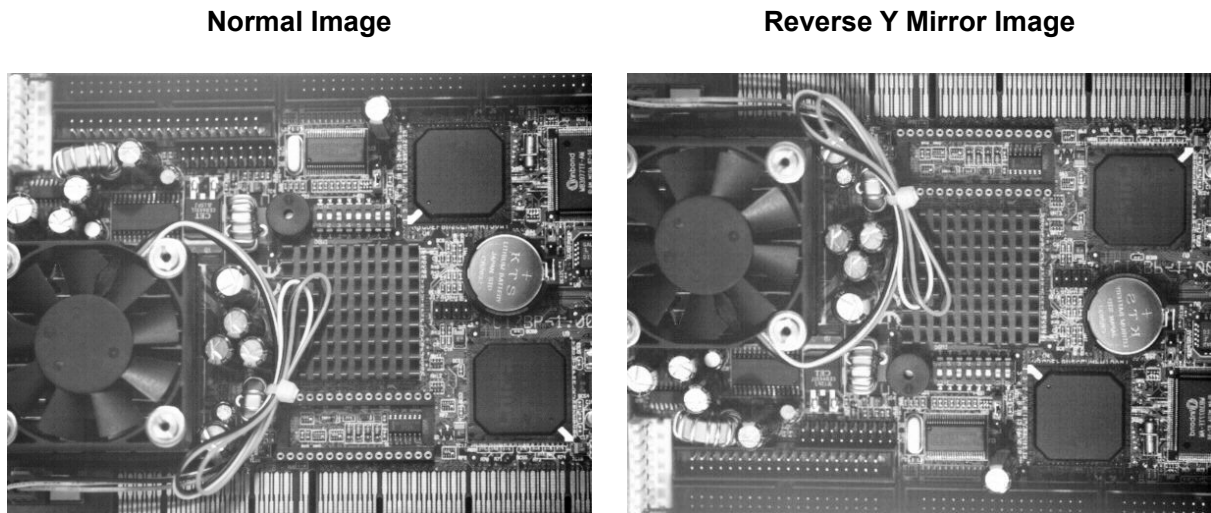

Fig. 57: Reverse Y Mirror Imaging



On color models of the camera, when either the reverse X feature or the reverse Y feature or both are used, the alignment of the color filter to the image remains Bayer GB. The camera includes a mechanism that keeps the filter alignment constant when these features are used. For more information about the color filter, see Section 8.1 on [page 104](#).



## The Effect of Reverse Y on the Auto Function AOIs

If you are using the camera's auto functions, you should be aware of the effect that using the reverse Y feature will have on the auto function AOIs. When reverse Y is used, the position of the auto function AOIs relative to the sensor remains the same. As a consequence, each auto function AOI will include a different portion of the captured image depending on whether or not the reverse Y feature is enabled. Figure 58 shows the effect of that reverse Y mirroring will have on the auto function AOIs.

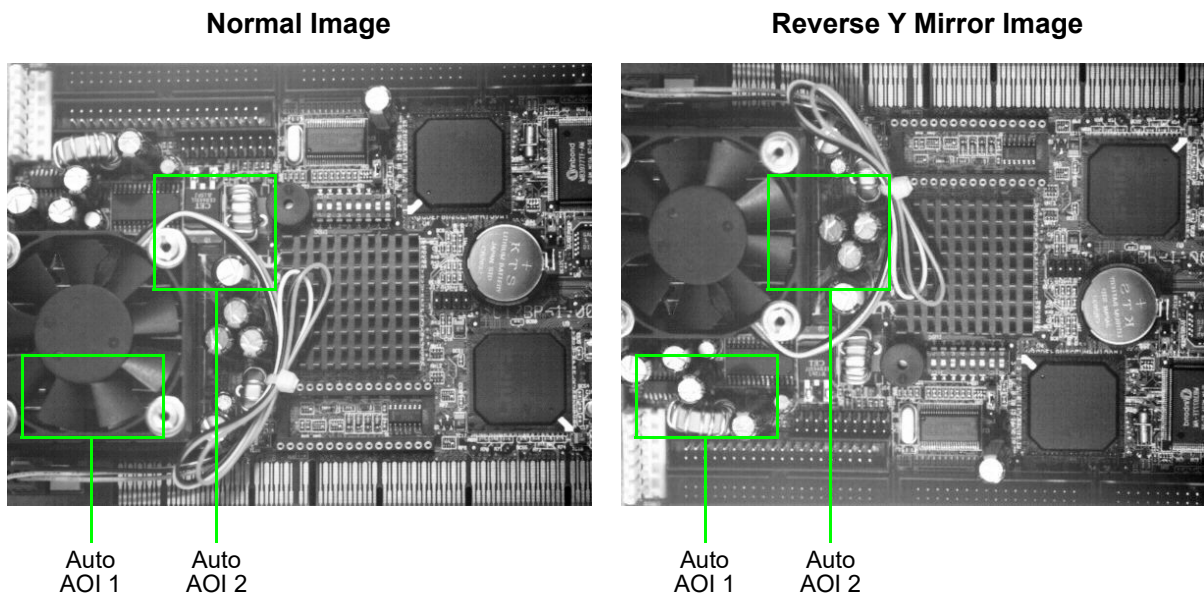

Fig. 58: Using Reverse Y Mirror Imaging with Auto Functions Enabled

For more information about auto functions and auto function AOIs, see Section 10.7 on [page 164](#).

## 10.12.3 Enabling Reverse X and Reverse Y

You can enable the reverse X and reverse Y features by setting the Reverse X and the Reverse Y parameter values. You can use the pylon API to set the parameter values from within your application software. The following code snippet illustrates using the API to set the parameter values:

```
// Enable reverse X
Camera.ReverseX.SetValue(true);

// Enable reverse Y
Camera.ReverseY.SetValue(true);
```

You can also use the Basler pylon Viewer application to easily set the parameter.

For more information about the pylon API and the pylon Viewer, see Section 3 on [page 21](#).



## 10.13 Luminance Lookup Table

Pixel data from the imaging sensor is digitized by the ADC at 12 bit depth. Whenever the camera is set for a 12 bit pixel format (e.g., Mono 12), the 12 bits transmitted out of the camera for each pixel normally represent the 12 bits reported by the camera's ADC. The luminance lookup table feature lets you use a custom 12 bit to 12 bit lookup table to map the 12 bits reported out of the ADC to 12 bits that will be transmitted by the camera.

The lookup table is essentially just a list of 4096 values, however, not every value in the table is actually used. If we number the values in the table from 0 through 4095, the table works like this:

- The number at location 0 in the table represents the 12 bits that will be transmitted out of the camera when the ADC reports that a pixel has a value of 0.
- The numbers at locations 1 through 7 are not used.
- The number at location 8 in the table represents the 12 bits that will be transmitted out of the camera when the ADC reports that a pixel has a value of 8.
- The numbers at locations 9 through 15 are not used.
- The number at location 16 in the table represents the 12 bits that will be transmitted out of the camera when the ADC reports that a pixel has a value of 16.
- The numbers at locations 17 through 23 are not used.
- The number at location 24 in the table represents the 12 bits that will be transmitted out of the camera when the ADC reports that a pixel has a value of 24.
- And so on.

As you can see, the table does not include a user defined 12 bit value for every pixel value that the sensor can report. So what does the camera do when the ADC reports a pixel value that is between two values that have a defined 12 bit output? In this case, the camera performs a straight line interpolation to determine the value that it should transmit. For example, assume that the ADC reports a pixel value of 12. In this case, the camera would perform a straight line interpolation between the values at location 8 and location 16 in the table. The result of the interpolation would be reported out of the camera as the 12 bit output.

Another thing to keep in mind about the table is that location 4088 is the last location that will have a defined 12 bit value associated with it. (Locations 4089 through 4095 are not used.) If the ADC reports a value above 4088, the camera will not be able to perform an interpolation. In cases where the ADC reports a value above 4088, the camera simply transmits the 12 bit value from location 4088 in the table.

The advantage of the luminance lookup table feature is that it allows a user to customize the response curve of the camera. The graphs below show the effect of two typical lookup tables. The first graph is for a lookup table where the values are arranged so that the output of the camera increases linearly as the digitized sensor output increases. The second graph is for a lookup table where the values are arranged so that the camera output increases quickly as the digitized sensor output moves from 0 through 2048 and increases gradually as the digitized sensor output moves from 2049 through 4096.

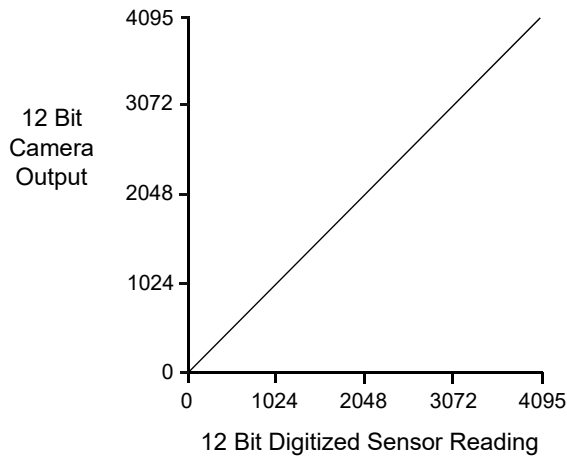

Fig. 59: Lookup Table with Values Mapped in a Linear Fashion

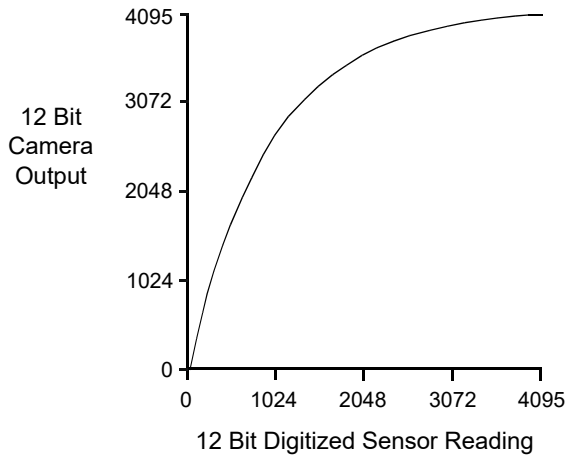

Fig. 60: Lookup Table with Values Mapped for Higher Camera Output at Low Sensor Readings

## Using the Luminance Lookup Table to Get 8 Bit Output

As mentioned above, when the camera is set for a pixel format where it outputs 12 bits, the lookup table is used to perform a 12 bit to 12 bit conversion. But the lookup table can also be used in 12 bit to 8 bit fashion. To use the table in 12 bit to 8 bit fashion, you enter 12 bit values into the table and enable the table as you normally would. But instead of setting the camera for a pixel format that results in a camera output with 12 bits effective, you set the camera for a pixel format that results in 8 bit output (e.g., Mono 8). In this situation, the camera will first use the values in the table to do a 12 bit to 12 bit conversion. It will then drop the 4 least significant bits of the converted value and will transmit the 8 most significant bits.

## Changing the Values in the Luminance Lookup Table and Enabling the Table

You can change the values in the luminance lookup table (LUT) and enable the use of the lookup table by doing the following:

- Use the LUT Selector to select a lookup table. (Currently there is only one lookup table available, i.e., the "luminance" lookup table described above.)
- Use the LUT Index parameter to select a value in the lookup table. The LUT Index parameter selects the value in the table to change. The index number for the first value in the table is 0, for the second value in the table is 1, for the third value in the table is 2, and so on.
- Use the LUT Value parameter to set the selected value in the lookup table.
- Use the LUT Index parameter and LUT value parameters to set other table values as desired.
- Use the LUT Enable parameter to enable the table.

You can set the LUT Selector, the LUT Index parameter and the LUT Value parameter from within your application software by using the Basler pylon API. The following code snippet illustrates using the API to set the selector and the parameter values:

```
// Select the lookup table
Camera.LUTSelector.SetValue( LUTSelector_Luminance );

// Write a lookup table to the device.
// The following lookup table causes an inversion of the sensor values
// ( bright -> dark, dark -> bright )
for ( int i = 0; i < 4096; i += 8 )
{
    Camera.LUTIndex.SetValue( i );
    Camera.LUTValue.SetValue( 4095 - i );
}
// Enable the lookup table
Camera.LUTEnable.SetValue( true );
```

For more information about the pylon API and the pylon Viewer, see Section 3 on [page 21](#).

## 10.14 Event Reporting

Event reporting is available on the camera. With event reporting, the camera can generate an "event" and transmit a related event message to the PC whenever a specific situation has occurred.

The camera can generate and transmit events for the following types of situations:

- An acquisition start trigger has occurred (AcquisitionStartEvent).
- Overtriggering of the acquisition start trigger has occurred (AcquisitionStartOvertriggerEventData).  
This happens if the camera receives an acquisition start trigger signal when it is not in a "waiting for acquisition start" acquisition status.
- A frame start trigger has occurred (FrameStartEvent).
- Overtriggering of the frame start trigger has occurred (FrameStartOvertriggerEventData).  
This happens if the camera receives a frame start trigger signal when it is not in a "waiting for frame start trigger" acquisition status.
- The end of an exposure has occurred (ExposureEndEventData).
- An event overrun has occurred (EventOverrunEventData).  
This situation is explained later in this section.

### An Example of Event Reporting

An example related to the Frame Start Overtrigger event illustrates how event reporting works. The example assumes that your system is set for event reporting (see below) and that the camera has received a frame start trigger when the camera is not in a "waiting for frame start trigger" acquisition status. In this case:

1. A Frame Start Overtrigger event is created. The event contains the event in the strict sense plus supplementary information:
  - An Event Type Identifier.* In this case, the identifier would show that a frame start overtrigger type event has occurred.
  - A Stream Channel Identifier.* Currently this identifier is always 0.
  - A Timestamp.* This is a timestamp indicating when the event occurred. (The time stamp timer starts running at power off/on or at camera reset. The unit for the timer is "ticks" where one tick = 8 ns. The timestamp is a 64 bit value.)
2. The event is placed in an internal queue in the camera.
3. As soon as network transmission time is available, an event message will be sent to the PC. If only one event is in the queue, the message will contain the single event. If more than one event is in the queue, the message will contain multiple events.
  - a. After the camera sends an event message, it waits for an acknowledgement. If no acknowledgement is received within a specified timeout, the camera will resend the event message. If an acknowledgement is still not received, the timeout and resend mechanism will repeat until a specified maximum number of retries is reached. If the maximum number of retries is reached and no acknowledge has been received, the message will be dropped.

During the time that the camera is waiting for an acknowledgement, no new event messages can be transmitted.

4. Event reporting involves making some additional software-related steps and settings. For more information, see the "Camera Events" code sample included with the pylon software development kit.

## The Event Queue

As mentioned in the example above, the camera has an event queue. The intention of the queue is to handle short term delays in the camera's ability to access the network and send event messages. When event reporting is working "smoothly", a single event will be placed in the queue and this event will be sent to the PC in an event message before the next event is placed in the queue. If there is an occasional short term delay in event message transmission, the queue can buffer several events and can send them within a single event message as soon as transmission time is available.

However, if you are operating the camera at high frame rates, the camera may be able to generate and queue events faster than they can be transmitted and acknowledged. In this case:

1. The queue will fill and events will be dropped.
2. An event overrun will occur.
3. Assuming that you have event overrun reporting enabled, the camera will generate an "event overrun event" and place it in the queue.
4. As soon as transmission time is available, an event message containing the event overrun event will be transmitted to the PC.

The event overrun event is simply a warning that events are being dropped. The notification contains no specific information about how many or which events have been dropped.

## Setting Your System for Event Reporting

Event reporting must be enabled in the camera and some additional software-related settings must be made. This is described in the "Camera Events" code sample included with the pylon software development kit.

Event reporting must be specifically set up for each type of event using the parameter name of the event and of the supplementary information. The following table lists the relevant parameter names:

Event	Event Parameter Name	Supplementary Information Parameter Name
Acquisition Start	AcquisitionStartEventData	AcquisitionStartEventStreamChannelIndex
		AcquisitionStartEventTimestamp
Acquisition Start Overtrigger	AcquisitionStartOvertriggerEventData	AcquisitionStartOvertriggerEventStreamChannelIndex
		AcquisitionStartOvertriggerEventTimestamp
Frame Start	FrameStartEventData	FrameStartEventStreamChannelIndex
		FrameStartEventTimestamp
Frame Start Overtrigger	FrameStartOvertriggerEventData	FrameStartOvertriggerEventStreamChannelIndex
		FrameStartOvertriggerEventTimestamp
Exposure End	ExposureEndEventData	ExposureEndEventFrameID
		ExposureEndEventStreamChannelIndex
		ExposureEndEventTimestamp
Event Overrun	EventOverrunEventData	EventOverrunEventStreamChannelIndex
		EventOverrunEventTimestamp

Table 13: Parameter Names of Events and Supplementary Information

You can enable event reporting and make the additional settings from within your application software by using the pylon API. The pylon software development kit includes a "Grab\_CameraEvents" code sample that illustrates the entire process.

For more detailed information about using the pylon API, refer to the Basler pylon Programmer's Guide and API Reference.

## 10.15 User Defined Values

The camera can store five "user defined values". These five values are 32 bit signed integer values that you can set and read as desired. They simply serve as convenient storage locations for the camera user and have no impact on the operation of the camera.

The five values are designated as Value 1, Value 2, Value 3, Value 4, and Value 5.

### Setting User Defined Values

Setting a user defined value using Basler pylon is a two step process:

- Set the User Defined Value Selector to Value 1, Value 2, Value 3, Value 4, or Value 5.
- Set the User Defined Value parameter to the desired value for the selected value.

You can use the pylon API to set the User Defined Value Selector and the User Defined Value parameter value from within your application software. The following code snippet illustrates using the API to set the selector and the parameter value:

```
// Set user defined value 1
Camera.UserDefinedValueSelector.SetValue( UserDefinedValueSelector_Value1 );
Camera.UserDefinedValue.SetValue( 1000 );

// Set user defined value 2
Camera.UserDefinedValueSelector.SetValue( UserDefinedValueSelector_Value2 );
Camera.UserDefinedValue.SetValue( 2000 );

// Get the value of user defined value 1
Camera.UserDefinedValueSelector.SetValue( UserDefinedValueSelector_Value1 );
int64_t UserValue1 = Camera.UserDefinedValue.GetValue();
```

You can also use the Basler pylon Viewer application to easily set the parameters.

For more information about the pylon API and the pylon Viewer, see Section 3 on [page 21](#).

## 10.16 Test Images

All cameras include the ability to generate test images. Test images are used to check the camera's basic functionality and its ability to transmit an image to the host PC. Test images can be used for service purposes and for failure diagnostics. For test images, the image is generated internally by the camera's logic and does not use the optics, the imaging sensor, or the ADCs. Five test images are available (for color cameras six test images).

### The Effect of Camera Settings on Test Images

When any of the test image is active, the camera's analog features such as gain, black level, and exposure time have no effect on the images transmitted by the camera. For test images 1, 2, 3, and 6 the camera's digital features, such as the luminance lookup table, will also have no effect on the transmitted images. But for test images 4 and 5, the camera's digital features will affect the images transmitted by the camera. This makes test images 4 and 5 a good way to check the effect of using a digital feature such as the luminance lookup table.

### Enabling a Test Image

With Basler pylon, the Test Image Selector is used to set the camera to output a test image. You can set the value of the Test Image Selector to enable one of the test images or to "test image off".

You can use the pylon API to set the Test Image Selector from within your application software. The following code snippets illustrate using the API to set the selector:

```
// Set for no test image
Camera.TestImageSelector.SetValue( TestImageSelector_Off );

// Set for test image 1
Camera.TestImageSelector.SetValue( TestImageSelector_Testimage1 );
```

You can also use the Basler pylon Viewer application to easily set the parameters.

For more information about the pylon API and the pylon Viewer, see Section 3 on [page 21](#).



## 10.16.1 Test Image Descriptions

### Test Image 1 - Fixed Diagonal Gray Gradient (8 bit)

This 8 bit fixed diagonal gray gradient test image is best suited for use when the camera is set for monochrome 8 bit output. The test image consists of fixed diagonal gray gradients ranging from 0 to 255.

If the camera is set for 8 bit output and is operating at full resolution, test image one will look similar to Figure 61.

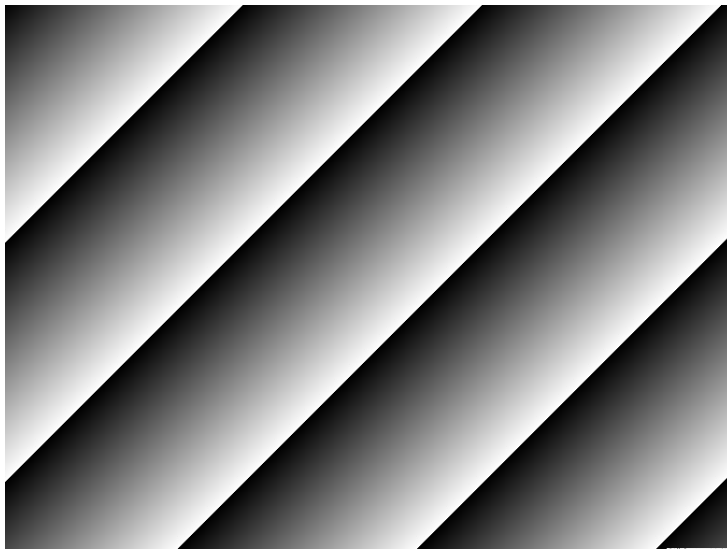

Fig. 61: Test Image 1

### Test Image 2 - Moving Diagonal Gray Gradient (8 bit)

The 8 bit moving diagonal gray gradient test image is similar to test image 1, but it is not stationary. The image moves by one pixel from right to left whenever a new image acquisition is initiated. The test pattern uses a counter that increments by one for each new image acquisition.

### **Test Image 3 - Moving Diagonal Gray Gradient (12 bit)**

The 12 bit moving diagonal gray gradient test image is similar to test image 2, but it is a 12 bit pattern. The image moves by one pixel from right to left whenever a new image acquisition is initiated. The test pattern uses a counter that increments by one for each new image acquisition.

### **Test Image 4 - Moving Diagonal Gray Gradient Feature Test (8 bit)**

The basic appearance of test image 4 is similar to test image 2 (the 8 bit moving diagonal gray gradient image). The difference between test image 4 and test image 2 is this: if a camera feature that involves digital processing is enabled, test image 4 **will** show the effects of the feature while test image 2 **will not**. This makes test image 4 useful for checking the effects of digital features such as the luminance lookup table.

### **Test Image 5 - Moving Diagonal Gray Gradient Feature Test (12 bit)**

The basic appearance of test image 5 is similar to test image 3 (the 12 bit moving diagonal gray gradient image). The difference between test image 5 and test image 3 is this: if a camera feature that involves digital processing is enabled, test image 5 **will** show the effects of the feature while test image 3 **will not**. This makes test image 5 useful for checking the effects of digital features such as the luminance lookup table.

## Test Image 6 - Moving Diagonal Color Gradient

Test image 6 is an 8 bit fixed diagonal color gradient test image. Test image 6 is available on color cameras only. When a color camera is set for test image 6, it delivers pixel data in the Bayer GB 8 format.

This test image can be used to test a color camera's basic ability to transmit a color image.

It can also be used to test whether your frame grabber is correctly set to interpolate images transmitted in the Bayer GB 8 format. If the colors in the images from your frame grabber do not exactly match the colors in test image 6 as shown below, then your frame grabber is incorrectly set.

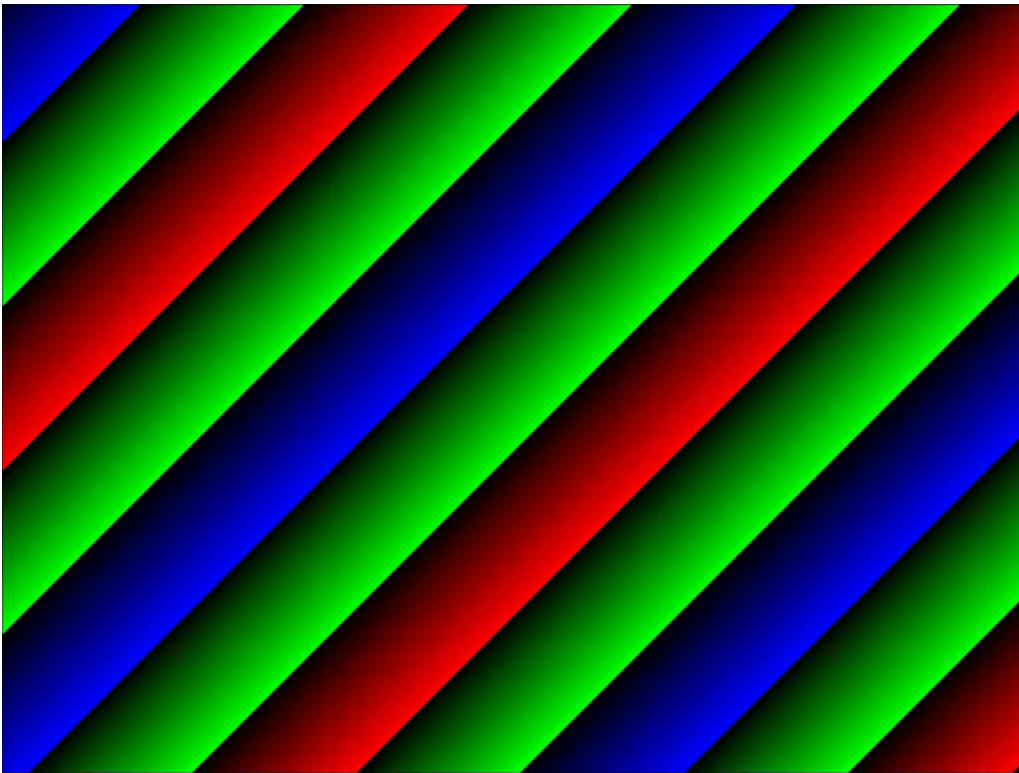

Fig. 62: Test Image 6

## 10.17 Device Information Parameters

Each camera includes a set of "device information" parameters. These parameters provide some basic information about the camera. The device information parameters include:

- Device Vendor Name (read only) - contains the camera vendor's name.
- Device Model Name (read only) - contains the model name of the camera.
- Device Manufacturer Info (read only) - can contain some information about the camera manufacturer. This string usually indicates "none".
- Device Version (read only) - contains the device version number for the camera.
- Device Firmware Version (read only) - contains the version of the firmware in the camera.
- Device ID (read only) - contains the serial number of the camera.
- Device User ID (read / write) - is used to assign a user defined name to a device. This name will be displayed in the Basler pylon Viewer and the Basler pylon IP Configurator. The name will also be visible in the "friendly name" field of the device information objects returned by pylon's device enumeration procedure.
- Device Scan Type (read only) - contains the scan type of the camera, for example, area scan.
- Sensor Width (read only) - contains the physical width of the sensor in pixels.
- Sensor Height (read only) - contains the physical height of the sensor.
- Max Width (read only) - Indicates the camera's maximum area of interest (AOI) width setting.
- Max Height (read only) - Indicates the camera's maximum area of interest (AOI) height setting.

You can read the values for all of the device information parameters or set the value of the Device User ID parameter from within your application software by using the Basler pylon API. The following code snippets illustrate using the API to read the parameters or write the Device User ID:

```
// Read the Vendor Name parameter
Pylon::String_t vendorName = Camera.DeviceVendorName.GetValue();

// Read the Model Name parameter
Pylon::String_t modelName = Camera.DeviceModelName.GetValue();

// Read the Manufacturer Info parameter
Pylon::String_t manufacturerInfo = Camera.DeviceManufacturerInfo.GetValue();

// Read the Device Version parameter
Pylon::String_t deviceVersion = Camera.DeviceVersion.GetValue();

// Read the Firmware Version parameter
Pylon::String_t firmwareVersion = Camera.DeviceFirmwareVersion.GetValue();

// Read the Device ID parameter
Pylon::String_t deviceID = Camera.DeviceID.GetValue();
```

```
// Write and read the Device User ID
Camera.DeviceUserID = "custom name";
Pylon::String_t deviceUserID = Camera.DeviceUserID.GetValue();

// Read the Sensor Width parameter
int64_t sensorWidth = Camera.SensorWidth.GetValue();

// Read the Sensor Height parameter
int64_t sensorHeight = Camera.SensorHeight.GetValue();

// Read the Max Width parameter
int64_t maxWidth = Camera.WidthMax.GetValue();

// Read the Max Height parameter
int64_t maxHeight = Camera.HeightMax.GetValue();
```

You can also use the Basler pylon Viewer application to easily read the parameters and to read or write the Device User ID.

You can use the Basler pylon IP Configurator to read or write the Device User ID.

For more information about the pylon API and the pylon Viewer, see Section 3 on [page 21](#).

# 10.18 Imaging Sensor Temperature Monitoring and Over Temperature Detection

## 10.18.1 Imaging Sensor Temperature

The camera is equipped with a temperature sensor mounted on the imaging sensor board. The temperature sensor lets you read the current temperature of the camera's imaging sensor board in degrees C.

### Reading the Imaging Sensor Temperature

You can use the pylon API to read the imaging sensor board temperature in degrees C from within your application software. Reading the temperature using Basler pylon is a two step process:

- Select the imaging sensor board temperature sensor.
- Read the temperature.

The following code snippet illustrates using the API to read the temperature in degrees C:

```
// Select the imaging sensor board temperature sensor
Camera.TemperatureSelector.SetValue ( TemperatureSelector_Sensorboard );

// Read the imaging sensor board temperature
double imgSensorTemp = Camera.TemperatureAbs.GetValue();
```

You can also use the Basler pylon Viewer application to easily read the temperature.

For more information about the pylon API and the pylon Viewer, see Section 3 on [page 21](#).

## 10.18.2 Imaging Sensor Temperature Conditions

The temperature sensor is used to monitor the temperature of the camera's imaging sensor board.

The camera also has imaging sensor over temperature protection. An over temperature condition is detected, if the temperature of the imaging sensor board rises above 75° C. Two stages can be distinguished:

### If the **temperature of the imaging sensor board**

- rises above 90 % of the over temperature of 75° C (i.e. 67.5° C), a **critical temperature condition** is detected. The camera function is unchanged as long as the temperature of the imaging sensor does not rise above 75° C. If the temperature rises above 75° C, an over temperature condition is detected (see next bullet point).  
As soon as the temperature of the imaging sensor board falls below 80 % of the over temperature (i.e. 63° C) the "critical temperature" status is reset.  
For information on how to check for a critical temperature condition, see below.
- rises above 75° C, an **over temperature condition** will be detected and the circuitry on the imaging sensor board will switch off. In this situation, you will still be able to communicate with the camera, however, the camera will not be able to acquire or transmit images. The imaging sensor board circuitry will remain off until its temperature falls below 75° C. Once the temperature is below 75°, the error condition will clear. After the error condition clears, the camera must be restarted before it will begin operating normally.  
For information on how to check for an over temperature condition, see below.

### Checking for an Imaging Sensor Board Temperature Condition Using Basler pylon

You can use the pylon API from within your application software to check whether the imaging sensor board is currently in a critical temperature condition or in an overtemp condition. Checking for the temperature condition using Basler pylon is a two step process:

- Select the imaging sensor board temperature sensor.
- Check for a critical temperature condition or an overtemp condition.

The following code snippet illustrates using the pylon API to read the temperature in degrees C:

```
// Select the imaging sensor board temperature sensor
Camera.TemperatureSelector.SetValue ( TemperatureSelector_Sensorboard
);
```

Depending on what temperature condition you want to check:

```
■ // Check for an imaging sensor board critical condition
  bool imgSensorCriticalTemp = Camera.CriticalTemperature.GetValue();
■ // Check for an imaging sensor board overtemp condition
  bool imgSensorOvertemp = Camera.OverTemperature.GetValue();
```

You can also use the Basler pylon Viewer application to easily check for an overtemperature condition.

For more information about the pylon API and the pylon Viewer, see Section 3 on [page 21](#).

## 10.19 Configuration Sets

A configuration set is a group of values that contains all of the parameter settings needed to control the camera. There are three basic types of configuration sets: the active set, the default set, and the user set.

### The Active Set

The active set contains the camera's current parameter settings and thus determines the camera's performance, that is, what your image currently looks like. When you change parameter settings using the pylon API or the pylon Viewer, you are making changes to the active set. The active set is located in the camera's volatile memory and the settings are lost if the camera is reset or if power is switched off.

### The Default Set

When a camera is manufactured, numerous tests are performed on the camera and four factory optimized setups are determined. The four factory optimized setups are:

- The Standard Factory Setup - is optimized for average conditions and will provide good camera performance in many common applications. In the standard factory setup, the gain is set to a low value, and all auto functions are set to off.
- The High Gain Factory Setup - is similar to the standard factory setup, but the gain is set to + 6 dB.
- The Auto Functions Factory Setup - is similar to the standard factory setup, but the Exposure Auto auto function is enabled and set to the continuous mode of operation.
- The Color Factory Setup - is optimized to yield the best color fidelity with daylight lighting.

The factory setups are saved in permanent files in the camera's non-volatile memory. They are not lost when the camera is reset or switched off and they cannot be changed.

You can select one of the factory setups to be the camera's "default set". Instructions for selecting which factory setup will be used as the default set appear later in the Configuration Sets section. Note that your selection of which factory setup will serve as the default set will not be lost when the camera is reset or switched off.

When the camera is running, the default set can be loaded into the active set. The default set can also be designated as the "startup" set, i.e., the set that will be loaded into the active set whenever the camera is powered on or reset. Instructions for loading the default set into the active set and for designating which set will be the startup set appear later in the Configuration Sets section.

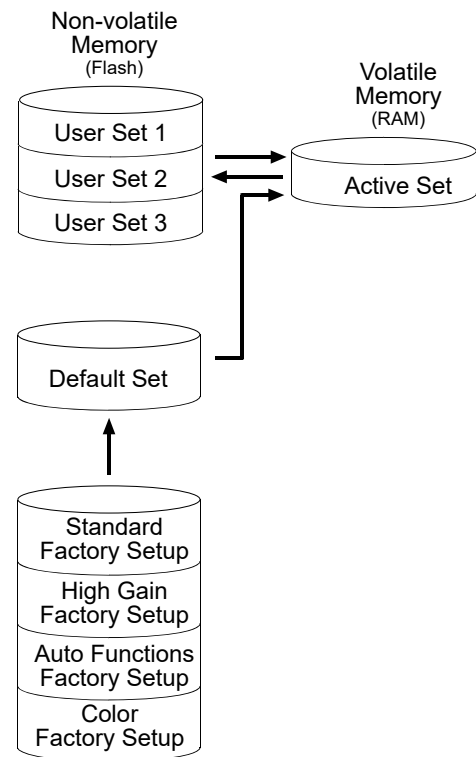

Fig. 63: Configuration Sets



## User Set

The active configuration set is stored in the camera's volatile memory and the settings are lost if the camera is reset or if power is switched off. The camera can save most of the settings from the current active set to a reserved area in the camera's non-volatile memory. A configuration set that has been saved in the non-volatile memory is not lost when the camera is reset or switched off. There is one reserved area in the camera's non-volatile memory available for saving a configuration set. A configuration set saved in the reserved area is commonly referred to as a "user set".

The three available user sets are called User Set 1, User Set 2, and User Set 3.

When the camera is running, the saved user set can be loaded into the active set. The saved user set can also be designated as the "startup" set, i.e., the set that will be loaded into the active set whenever the camera is powered on or reset. Instructions for loading a saved user set into the active set and for designating which set will be the startup set appear later in the Configuration sets section.



The values for the luminance lookup table are not saved in the user set and are lost when the camera is reset or switched off. If you are using the lookup table feature, you must reenter the lookup table values after each camera startup or reset.

## Designating a Startup Set

You can designate the default set or the user set as the "startup" set. The designated startup set will automatically be loaded into the active set whenever the camera starts up at power on or after a reset. Instructions for designating the startup set appear later in the Configuration Sets section.

## 10.19.1 Selecting a Factory Setup as the Default Set

When the camera is delivered, the Standard Factory Setup will be selected as the default set. You can, however, select any one of the four factory setups to serve as the default set.

To select which factory setup will serve as the default set using Basler pylon:

- Set the Default Set Selector to the Standard Factory Setup, High Gain Factory Setup, Auto Functions Factory Setup or Color Factory Setup.

You can set the Default Set Selector from within your application software by using the pylon API. The following code snippet illustrates using the API to set the selector:

If you want to select the Standard Factory Setup:

```
Camera.DefaultSetSelector.SetValue(DefaultSetSelector_Standard);
```

If you want to select the High Gain Factory Setup:

```
Camera.DefaultSetSelector.SetValue(DefaultSetSelector_HighGain);
```

If you want to select the Auto Functions Factory Setup:

```
Camera.DefaultSetSelector.SetValue(DefaultSetSelector_AutoFunctions);
```

If you want to select the Color Factory Setup:

```
Camera.DefaultSetSelector.SetValue(DefaultSetSelector_Color);
```



Selecting which factory setup will serve as the default set is only allowed when the camera is idle, i.e. when it is not acquiring images continuously or does not have a single image acquisition pending.

Selecting the standard factory setup as the default set and then loading the default set into the active set is a good course of action if you have grossly misadjusted the settings in the camera and you are not sure how to recover. The standard factory setup is optimized for use in typical situations and will provide good camera performance in most cases.

For more information about the pylon API and the pylon Viewer, see Section 3 on [page 21](#).

## 10.19.2 Saving User Sets

You can save the current parameter set being used by the camera (i.e., the "active" set in the camera's volatile memory) to user set 1, user set 2, or user set 3. The user sets are stored in the camera's non-volatile memory and will be retained when the camera power is switched off or the camera is reset. When you save the active set to a user set, any parameter data already in that user set will be overwritten.

Using Basler pylon to save the current active set to a user set in the camera's non-volatile memory is a several step process:

- Make changes to the camera's settings until the camera is operating in a manner that you would like to save.
- Set the User Set Selector to User Set 1, User Set 2, or User Set 3 as desired.
- Execute a User Set Save command to save the active set to the selected user set.

Saving an active set to a user set in the camera's non-volatile memory will overwrite any parameters that were previously saved in that user set.

You can use the pylon API to set the User Set Selector and to execute the User Set Save command from within your application software. The following code snippet illustrates using the API to set the selector and execute the command:

```
Camera.UserSetSelector.SetValue( UserSetSelector_UserSet1 );  
Camera.UserSetSave.Execute( );
```

You can also use the Basler pylon Viewer application to easily set the parameters.

For more information about the pylon API and the pylon Viewer, see Section 3 on [page 21](#).

## 10.19.3 Loading a Saved User Set or the Default Set into the Active Set

If you have saved a configuration set into one of the user sets in the camera's non-volatile memory, you can load the saved user set into the camera's active set. When you do this, the parameters stored in the user set overwrite the parameters in the active set. Since the settings in the active set control the current operation of the camera, the settings from the loaded user set will now be controlling the camera.

You can also load the default set into the camera's active set.



Loading a user set or the default set into the active set is only allowed when the camera is idle, i.e. when it is not acquiring an image.

Assuming that you have selected the standard factory setup as the default set, loading the default set into the active set is a good course of action if you have grossly misadjusted the settings in the camera and you are not sure how to recover. The standard factory setup is optimized for use in typical situations and will provide good camera performance in most cases.

Loading a saved user set or the default set from the camera's non-volatile memory into the active set using Basler pylon is a two step process:

- Set the User Set Selector to User Set 1, User Set 2, User Set 3, or Default as desired.
- Execute a User Set Load command to load the selected set into the active set.

You can use the pylon API to set the User Set Selector and to execute the User Set Load command from within your application software. The following code snippet illustrates using the API to set the selector and execute the command:

```
// Load user set 2 into the active set
Camera.UserSetSelector.SetValue( UserSetSelector_UserSet2 );
Camera.UserSetLoad.Execute( );

// Load the default set into the active set
Camera.UserSetSelector.SetValue( UserSetSelector_Default );
Camera.UserSetLoad.Execute( );
```

For more information about the pylon API and the pylon Viewer, see Section 3 on [page 21](#).

## 10.19.4 Selecting a "Startup" Set

You can select the default set or one of the user sets stored in the camera's non-volatile memory to be the "startup" set. The configuration set that you select as the startup set will be loaded into the active set whenever the camera starts up at power on or after a reset.

With Basler pylon, the User Set Default Selector parameter is used to select User Set 1, User Set 2, User Set 3, or the Default Set as the startup set.

You can use the pylon API to set the User Set Default Selector parameter from within your application software. The following code snippet illustrates using the API to set the selector:

```
// Designate user set 1 as the startup set
Camera.UserSetDefaultSelector.SetValue( UserSetDefaultSelector_UserSet1 );

// Designate the default set as the startup set
Camera.UserSetDefaultSelector.SetValue( UserSetDefaultSelector_Default );
```

For more information about the pylon API and the pylon Viewer, see Section 3 on [page 21](#).

## 10.20 Camera Feature Set

After the camera is powered on, pylon software processes a camera description file to make the camera features available for use. The camera description file is included in the camera and describes the camera features in accord with the GenICam specification.

The Basler aviator GigE cameras include two camera description files that are used alternatively. The camera description files represent partially different combinations of features (feature sets).

To obtain the desired feature set for use you must select the related camera description file by setting the CameraFeatureSet parameter value and restarting the camera (see below).



The CameraFeatureSet parameter setting persists when the camera is switched off and on. Accordingly, the current camera description file will serve as the default camera description file whenever the camera is powered on, until the other camera description file is selected.

You can use either one of the following camera description files:

- The "Full" camera description file provides the complete feature set. All features will be available.
- The "Basic" camera description file provides all features **except** the following ones:
  - Color adjustment (see Section 8.3 on [page 108](#))
  - Sequencer (see Section 10.10 on [page 185](#))

Accordingly, the features listed above will not be available.

Processing the selected camera description file takes some time. The time depends on the number and nature of the included features. Accordingly, the different camera description files require different periods to elapse until the camera features are available for use.



The camera features are sooner available when you use the "Basic" camera description file after camera restart or camera reset.



If you will only use the smaller feature set, we recommend to leave the CameraFeatureSet parameter value at the "Basic" factory setting. This will make the camera features sooner available after camera restart or camera reset.

**To activate a camera description file:**

1. Select the camera description file by setting the CameraFeatureSet parameter value to either "Full" or "Basic", as desired.
2. Restart the camera by switching camera power off and on again.  
The feature set relating to the selected camera description file is available after some period.

**Setting the Parameter Value**

You can select a camera description file by setting the CameraFeatureSet parameter value from within your application software by using the pylon API. The following code snippet illustrates using the API to set the parameter value (in the example the camera description file providing the complete feature set is chosen):

```
// Select the camera description file providing all camera features
CEnumerationPtr ptrFeatureSet( Camera.GetNodeMap().GetNode("FeatureSet"));
ptrFeatureSet->FromString("Full");
```

For detailed information about using the pylon API, refer to the Basler pylon Programmer's Guide and API Reference.

You can also use the Basler pylon Viewer application to easily set the parameter.

For more information about the pylon Viewer, see Section 3.1.1 on [page 22](#).

# 11 Chunk Features

This section provides detailed information about the chunk features available on each camera.

## 11.1 What are Chunk Features?

In most cases, enabling a camera feature will simply change the behavior of the camera. The Test Image feature is a good example of this type of camera feature. When the Test Image feature is enabled, the camera outputs a test image rather than a captured image. This type of feature is referred to as a "standard" feature.

When certain camera features are enabled, the camera actually develops some sort of information about each image that it acquires. In these cases, the information is added to each image as a trailing data "chunk" when the image is transferred to the host PC. Examples of this type of camera feature are the Frame Counter feature and the Time Stamp feature. When the Frame Counter feature is enabled, for example, after an image is captured, the camera checks a counter that tracks the number of images acquired and develops a frame counter stamp for the image. And if the Time Stamp feature is enabled, the camera creates a time stamp for the image. The frame counter stamp and the time stamp would be added as "chunks" of trailing data to each image as the image is transferred from the camera. The features that add chunks to the acquired images are referred to as "chunk" features.

Before you can use any of the features that add chunks to the image, you must make the chunk mode active. Making the chunk mode active is described in the next section.



## 11.2 Making the "Chunk Mode" Active and Enabling the Extended Data Stamp

Before you can use any of the camera's "chunk" features, the "chunk mode" must be made active. Making the chunk mode active does two things:

- It makes the Frame Counter, the Trigger Input Counter, the Time Stamp, the Line Status All, and the CRC Checksum, Stride, and Sequence Set Index chunk features available to be enabled.
- It automatically enables the Extended Image Data chunk feature.

To make the chunk mode active:

- Set the Chunk Mode Active parameter to true.

You can set the Chunk Mode Active parameter value from within your application software by using the Basler pylon API. The following code snippet illustrates using the API to set the parameter value:

```
Camera.ChunkModeActive.SetValue( true );
```

**Note that making the chunk mode inactive switches all chunk features off.**

Also note that when you enable `ChunkModeActive`, the `PayloadType` for the camera changes from `"Pylon::PayloadType_Image"` to `"Pylon::PayloadType_ChunkData"`.

For detailed information about using the pylon API, refer to the Basler pylon Programmer's Guide and API Reference.

You can also use the Basler pylon Viewer application to easily set the parameters.

Once the chunk mode is active and the Extended Image Data feature has been enabled, the camera will automatically add an "extended image data" chunk to each acquired image. The extended image data chunk appended to each acquired image contains some basic information about the image. The information contained in the chunk includes:

- The X Offset, Y Offset, Width, and Height for the AOI
- The Pixel Format of the image
- The Minimum Dynamic Range and the Maximum Dynamic Range

To retrieve data from the extended image data chunk appended to an image that has been received by your PC, you must first run the image and its appended chunks through the chunk parser included in the pylon API. Once the chunk parser has been used, you can retrieve the extended image data by doing the following:

- Read the value of the Chunk Offset X parameter.
- Read the value of the Chunk Offset Y parameter.
- Read the value of the Chunk Width parameter.
- Read the value of the Chunk Height parameter.
- Read the value of the Chunk Pixel Format parameter.
- Read the value of the Chunk Dynamic Range Min.
- Read the value of the Chunk Dynamic Range Max.
- Read the value of the Chunk Stride parameter.

The following code snippet illustrates using the pylon API to run the parser and retrieve the extended image data:

```
// retrieve data from the extended image data chunk
IChunkParser &ChunkParser = *Camera.CreateChunkParser();
GrabResult Result;
StreamGrabber.RetrieveResult( Result );
ChunkParser.AttachBuffer( (unsigned char*) Result.Buffer(),
    Result.GetPayloadSize() );
int64_t offsetX = Camera.ChunkOffsetX.GetValue();
int64_t offsetY = Camera.ChunkOffsetY.GetValue();
int64_t width = Camera.ChunkWidth.GetValue();
int64_t height = Camera.ChunkHeight.GetValue();
int64_t dynamicRangeMin = Camera.ChunkDynamicRangeMin.GetValue();
int64_t dynamicRangeMax = Camera.ChunkDynamicRangeMax.GetValue();
ChunkPixelFormatEnums pixelFormat = Camera.ChunkPixelFormat.GetValue();
int64_t stride = Camera.ChunkStride.GetValue();
```

For more information about using the chunk parser, see the sample code that is included with the Basler pylon Software Development Kit (SDK).

For more information about the pylon API and the pylon Viewer, see Section 3 on [page 21](#).

## 11.3 Frame Counter

The Frame Counter feature numbers frames sequentially as they are acquired. When the feature is enabled, a chunk is added to each frame containing the value of the counter.

The frame counter is a 32 bit value. The counter starts at 0 and increments by 1 for each acquired frame. The counter counts up to 4294967295 unless it is reset before (see below). After reaching the maximum value, the counter will reset to 0 and then continue counting.

Be aware that if the camera is acquiring frames continuously and continuous capture is stopped, several numbers in the counting sequence may be skipped. This happens due to the internal image buffering scheme used in the camera.



The chunk mode must be active before you can enable the frame counter feature or any of the other chunk feature. Making the chunk mode inactive disables all chunk features.

To enable the frame counter chunk:

- Use the Chunk Selector to select the Frame Counter chunk.
- Use the Chunk Enable parameter to set the value of the chunk to true.

Once the frame counter chunk is enabled, the camera will add a frame counter chunk to each acquired image.

To retrieve data from a chunk appended to an image that has been received by your PC, you must first run the image and its appended chunks through the chunk parser included in the pylon API. Once the chunk parser has been used, you can retrieve the frame counter information by doing the following:

- Read the value of the Chunk Frame Counter parameter.

You can set the Chunk Selector and Chunk Enable parameter value from within your application software by using the Basler pylon API. You can also run the parser and retrieve the chunk data. The following code snippets illustrate using the API to activate the chunk mode, enable the frame counter chunk, run the parser, and retrieve the frame counter chunk data:

```
// make chunk mode active and enable Frame Counter chunk
Camera.ChunkModeActive.SetValue( true );
Camera.ChunkSelector.SetValue( ChunkSelector_Framecounter );
Camera.ChunkEnable.SetValue( true );

// retrieve data from the chunk
IChunkParser &ChunkParser = *Camera.CreateChunkParser();
GrabResult Result;
StreamGrabber.RetrieveResult( Result );
ChunkParser.AttachBuffer( (unsigned char*) Result.Buffer(),
```

```
Result.GetPayloadSize() );  
int64_t frameCounter = Camera.ChunkFramecounter.GetValue();
```

You can also use the Basler pylon Viewer application to easily set the parameters.

For more information about the pylon API and the pylon Viewer, see Section 3 on [page 21](#).

## Comparing Counter Chunk Data

When comparing trigger input counter data and frame counter data related to the same image, be aware that the trigger input counter initially starts at 1 whereas the frame counter starts at 0. Therefore, the trigger input count will always be ahead of the matching frame count by one if both counters were started at the same time and if an image was acquired for every trigger.

Whenever the counters restart after having reached 4294967295 they will both start another counting cycle at 0. Accordingly, the difference between matching counts will always be one, regardless of the number of counting cycles.

Note that if both counters were started at the same time and not reset since and if the trigger input counter is ahead of the matching frame counter by more than one, the camera was overtriggered and not all external triggers resulted in frame acquisitions.

## Frame Counter Reset

Whenever the camera is powered off, the frame counter will reset to 0.

During operation, you can reset the frame counter via software or via I/O input line 1 or line 2. You can also disable the ability to perform a reset by setting the reset source to off. By default, frame counter reset is disabled.

To use the frame counter reset feature:

- Configure the frame counter reset by setting the counter selector to Counter2 and setting the counter event source to FrameStart.
- Set the counter reset source to line 1, line 2, software, or off.
- Execute the command if using software as the counter reset source.

You can set the frame counter reset parameter values from within your application software by using the Basler pylon API. The following code snippets illustrate using the API to configure and set the frame counter reset and to execute a reset via software.

```
// Configure reset of the frame counter  
Camera.CounterSelector.SetValue( CounterSelector_Counter2 );  
Camera.CounterEventSource.SetValue( CounterEventSource_FrameStart );  
  
// Select reset by signal applied to input line 1  
Camera.CounterResetSource.SetValue( CounterResetSource_Line1 );  
  
// Select reset by software  
Camera.CounterResetSource.SetValue( CounterResetSource_Software );
```

```
// Execute reset by software
Camera.CounterReset.Execute();

// Disable reset
Camera.CounterResetSource.SetValue( CounterResetSource_Off );
```

You can also use the Basler pylon Viewer application to easily set the parameters.

For more information about

- the Basler pylon API and the pylon Viewer, see Section 3 on [page 21](#).
- using an input line as the source signal for a frame counter reset, see Section 6.1.1 on [page 41](#).

## 11.4 Time Stamp

The Time Stamp feature adds a chunk to each acquired frame containing a time stamp that was generated when frame acquisition was triggered.

The time stamp is a 64 bit value. The time stamp is based on a counter that counts the number of "time stamp clock ticks" generated by the camera. The unit for each tick is 8 ns (as specified by the Gev Timestamp Tick Frequency). The counter starts at camera reset or at power on.



The chunk mode must be active before you can enable the time stamp feature or any of the other chunk feature. Making the chunk mode inactive disables all chunk features.

To enable the time stamp chunk:

- Use the Chunk Selector to select the Time Stamp chunk.
- Use the Chunk Enable parameter to set the value of the chunk to true.

Once the time stamp chunk is enabled, the camera will add a time stamp chunk to each acquired image.

To retrieve data from a chunk appended to an image that has been received by your PC, you must first run the image and its appended chunks through the chunk parser that is included in the pylon API. Once the chunk parser has been used, you can retrieve the time stamp information by doing the following:

- Read the value of the Chunk Time Stamp parameter.

You can set the Chunk Selector and Chunk Enable parameter value from within your application software by using the Basler pylon API. You can also run the parser and retrieve the chunk data. The following code snippets illustrate using the API to activate the chunk mode, enable the time stamp chunk, run the parser, and retrieve the frame counter chunk data:

```
// make chunk mode active and enable Time Stamp chunk
Camera.ChunkModeActive.SetValue( true );
Camera.ChunkSelector.SetValue( ChunkSelector_Timestamp );
Camera.ChunkEnable.SetValue( true );

// retrieve data from the chunk
IChunkParser &ChunkParser = *Camera.CreateChunkParser();
GrabResult Result;
StreamGrabber.RetrieveResult( Result );
ChunkParser.AttachBuffer( (unsigned char*) Result.Buffer(),
    Result.GetPayloadSize() );
int64_t timeStamp = Camera.ChunkTimestamp.GetValue();
```

You can also use the Basler pylon Viewer application to easily set the parameters.

For more information about the Basler pylon API and the pylon Viewer, see Section 3 on [page 21](#).

## 11.5 Trigger Input Counter

The Trigger Input Counter feature numbers external frame acquisition triggers sequentially as they are received. When the feature is enabled, a chunk is added to each image containing the value of the trigger input counter.

The trigger input counter is a 32 bit value. On the first counting cycle, the counter starts at 1 and increments by 1 for each received trigger. The counter counts up to 4294967295 unless it is reset before (see below). After reaching the maximum value, the counter will reset to 0 and then continue counting.

Be aware that if the camera is operating with the frame trigger off, the trigger input counter will not be available.



The chunk mode must be active before you can enable the trigger input counter feature or any of the other chunk feature. Making the chunk mode inactive disables all chunk features.

To enable the trigger input counter chunk:

- Use the Chunk Selector to select the Trigger Input Counter chunk.
- Use the Chunk Enable parameter to set the value of the chunk to true.

Once the trigger input counter chunk is enabled, the camera will add a trigger input counter chunk to each acquired image.

To retrieve data from a chunk appended to an image that has been received by your PC, you must first run the image and its appended chunks through the chunk parser included in the pylon API. Once the chunk parser has been used, you can retrieve the trigger input counter information by doing the following:

- Read the value of the Chunk Trigger Input Counter parameter.

You can set the Chunk Selector and Chunk Enable parameter value from within your application software by using the Basler pylon API. You can also run the parser and retrieve the chunk data. The following code snippets illustrate using the API to activate the chunk mode, enable the trigger input counter chunk, run the parser, and retrieve the trigger input counter chunk data:

```
// make chunk mode active and enable Trigger Input Counter chunk
Camera.ChunkModeActive.SetValue( true );
Camera.ChunkSelector.SetValue( ChunkSelector_Triggerinputcounter );
Camera.ChunkEnable.SetValue( true );

// retrieve data from the chunk
IChunkParser &ChunkParser = *Camera.CreateChunkParser();
GrabResult Result;
StreamGrabber.RetrieveResult( Result );
```

```

ChunkParser.AttachBuffer( (unsigned char*) Result.Buffer(),
    Result.GetPayloadSize() );
int64_t triggerinputCounter = Camera.ChunkTriggerinputcounter.GetValue();

```

You can also use the Basler pylon Viewer application to easily set the parameters.

For more information about the Basler pylon API and the pylon Viewer, see Section 3 on [page 21](#).

## Comparing Counter Chunk Data

When comparing trigger input counter data and frame counter data related to the same image, be aware that the trigger input counter initially starts at 1 whereas the frame counter starts at 0. Therefore, the trigger input count will always be ahead of the matching frame count by one if both counters were started at the same time and if an image was acquired for every trigger.

Whenever the counters restart after having reached 4294967295 they will both start another counting cycle at 0. Accordingly, the difference between matching counts will always be one, regardless of the number of counting cycles.

Note that if both counters were started at the same time and not reset since and if the trigger input counter is ahead of the matching frame counter by more than one, the camera was overtriggered and not all external triggers resulted in frame acquisitions.

## Trigger Input Counter Reset

Whenever the camera is powered off, the trigger input counter will reset to 0.

During operation, you can reset the trigger input counter via software or via I/O input line 1 or line 2. You can also disable the ability to perform a reset by setting the rest source to off. By default, trigger input counter reset is disabled.

To use the trigger input counter reset feature:

- Configure the trigger input counter reset by setting the counter selector to Counter1 and setting the counter event source to FrameTrigger.
- Set the counter reset source to line1, line 2, software, or off.
- Execute the command if using software as the counter reset source.

You can set the trigger input counter reset parameter values from within your application software by using the Basler pylon API. The following code snippets illustrate using the API to configure and set the trigger input counter reset and to execute a reset via software.

```

// Configure reset of trigger input counter
Camera.CounterSelector.SetValue( CounterSelector_Counter1 );
Camera.CounterEventSource.SetValue( CounterEventSource_FrameTrigger );

// Select reset by signal applied to input line 1
Camera.CounterResetSource.SetValue( CounterResetSource_Line1 );

// Select reset by software

```



```
Camera.CounterResetSource.SetValue( CounterResetSource_Software );  
// Execute reset by software  
Camera.CounterReset.Execute();  
  
// Disable reset  
Camera.CounterResetSource.SetValue( CounterResetSource_Off );
```

You can also use the Basler pylon Viewer application to easily set the parameters.

For more information about

- the Basler pylon API and the pylon Viewer, see Section 3 on [page 21](#).
- using an input line as the source signal for a trigger input counter reset, see Section 6.1.1 on [page 41](#).

## 11.6 Line Status All

The Line Status All feature samples the status of all of the camera's input lines and output lines each time an image acquisition is triggered. It then adds a chunk to each acquired image containing the line status information.

The line status all information is a 32 bit value. As shown in Figure 64, certain bits in the value are associated with each line and the bits will indicate the state of the lines. If a bit is 0, it indicates that the state of the associated line was low at the time of triggering. If a bit is 1, it indicates that the state of the associated line is was high at the time of triggering.

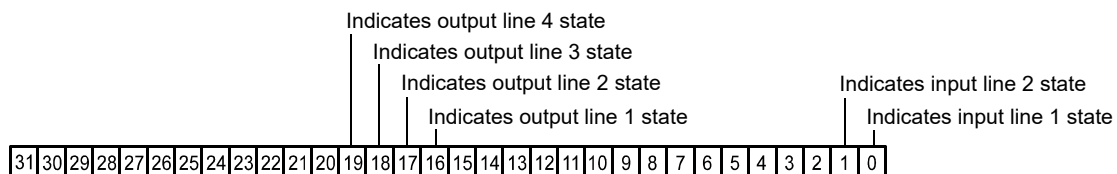

Fig. 64: Line Status All Parameter Bits



### Note

The chunk mode must be active before you can enable the line status all feature or any of the other chunk feature. Making the chunk mode inactive disables all chunk features.

To enable the line status all chunk:

- Use the Chunk Selector to select the Line Status All chunk.
- Use the Chunk Enable parameter to set the value of the chunk to true.

Once the line status all chunk is enabled, the camera will add a line status all chunk to each acquired image.

To retrieve data from a chunk appended to an image that has been received by your PC, you must first run the image and its appended chunks through the chunk parser included in the pylon API. Once the chunk parser has been used, you can retrieve the line status all information by doing the following:

- Read the value of the Chunk Line Status All parameter.

You can set the Chunk Selector and Chunk Enable parameter value from within your application software by using the pylon API. You can also run the parser and retrieve the chunk data. The following code snippets illustrate using the API to activate the chunk mode, enable the line status all chunk, run the parser, and retrieve the line status all chunk data:

```
// Make chunk mode active and enable Line Status All chunk
Camera.ChunkModeActive.SetValue( true );
Camera.ChunkSelector.SetValue( ChunkSelector_LineStatusAll );
```

```
Camera.ChunkEnable.SetValue( true );

// Retrieve data from the chunk
IChunkParser &ChunkParser = *Camera.CreateChunkParser();
GrabResult Result;
StreamGrabber.RetrieveResult( Result );
ChunkParser.AttachBuffer( (unsigned char*) Result.Buffer(),
    Result.GetPayloadSize() );
int64_t lineStatusAll = Camera.ChunkLineStatusAll.GetValue();
```

You can also use the Basler pylon Viewer application to easily set the parameters.

For more information about the Basler pylon API and the pylon Viewer, see Section 3 on [page 21](#).

## 11.7 CRC Checksum

The CRC (Cyclic Redundancy Check) Checksum feature adds a chunk to each acquired image containing a CRC checksum calculated using the X-modem method. As shown in Figure 6-2, the checksum is calculated using all of the image data and all of the appended chunks except for the checksum itself. The CRC chunk is always the last chunk appended to the image data.

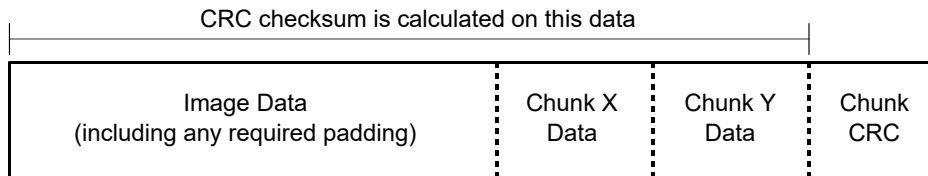



Fig. 65: CRC Checksum

	<p>The chunk mode must be active before you can enable the CRC feature or any of the other chunk feature. Making the chunk mode inactive disables all chunk features.</p>
---	---

To enable the CRC checksum chunk:

- Use the Chunk Selector to select the CRC chunk.
- Use the Chunk Enable parameter to set the value of the chunk to true.

Once the CRC chunk is enabled, the camera will add a CRC chunk to each acquired image.

To retrieve CRC information from a chunk appended to an image that has been received by your PC, you must first run the image and its appended chunks through the chunk parser included in the pylon API. Once the chunk parser has been used, you can retrieve the CRC information. Note that the CRC information provided by the chunk parser is not the CRC checksum itself. Rather it is a true/false result. When the image and appended chunks pass through the parser, the parser calculates a CRC checksum based on the received image and chunk information. It then compares the calculated CRC checksum with the CRC checksum contained in the CRC checksum chunk. If the two match, the result will indicate that the image data is OK. If the two do not match, the result will indicate that the image is corrupted.

You can set the Chunk Selector and Chunk Enable parameter value from within your application software by using the Basler pylon API. You can also run the parser and retrieve the chunk data. The following code snippets illustrate using the API to activate the chunk mode, enable the time stamp chunk, run the parser, and retrieve the frame counter chunk data:

```
// Make chunk mode active and enable CRC chunk
Camera.ChunkModeActive.SetValue( true );
Camera.ChunkSelector.SetValue( ChunkSelector_PayloadCRC16 );
Camera.ChunkEnable.SetValue( true );
```

```
// Check the CRC checksum of an grabbed image
IChunkParser &ChunkParser =
    *Camera.CreateChunkParser();
GrabResult Result;
StreamGrabber.RetrieveResult( Result );
ChunkParser.AttachBuffer( (unsigned char*) Result.Buffer(),
    Result.GetPayloadSize() );
if ( ChunkParser.HasCRC() && ! ChunkParser.CheckCRC() )
    cerr << "Image corrupted!" << endl;
```

You can also use the Basler pylon Viewer application to easily set the parameters.

For more information about the Basler pylon API and the pylon Viewer, see Section 3 on [page 21](#).

## 11.8 Sequence Set Index

The Sequence Set Index chunk adds a chunk to each acquired frame containing the index number of the sequence set that was used for frame acquisition.



The sequencer feature must be enabled before you can enable the sequence set index feature.  
For more information about the sequencer feature, see the "Sequencer" section.



The chunk mode must be active before you can enable the sequence set index feature or any of the other chunk features. Making the chunk mode inactive disables all chunk features.

To enable the sequence set index chunk:

- Use the Chunk Selector to select the Sequence Set Index chunk.
- Use the Chunk Enable parameter to set the value of the chunk to true.

Once the sequence set index chunk is enabled, the camera will add a sequence set index chunk to each acquired image.

To retrieve data from a chunk appended to an image that has been received by your PC, you must first run the image and its appended chunks through the chunk parser that is included in the pylon API. Once the chunk parser has been used, you can retrieve the sequence set index information by doing the following:

- Read the value of the Chunk Sequence Set Index parameter.

You can set the Chunk Selector and Chunk Enable parameter value from within your application software by using the Basler pylon API. You can also run the parser and retrieve the chunk data. The following code snippets illustrate using the API to activate the chunk mode, enable the time stamp chunk, run the parser, and retrieve the frame counter chunk data:

```
// Make chunk mode active and enable Sequence Set Index chunk
Camera.ChunkModeActive.SetValue( true );
Camera.ChunkSelector.SetValue( ChunkSelector_SequenceSetIndex );
Camera.ChunkEnable.SetValue( true );

// Retrieve data from the chunk
IChunkParser &ChunkParser = *Camera.CreateChunkParser();
GrabResult Result;
StreamGrabber.RetrieveResult( Result );
ChunkParser.AttachBuffer( (unsigned char*) Result.Buffer(),
    Result.GetPayloadSize() );
int64_t timeStamp = Camera.ChunkSequenceSetIndex.GetValue();
```

You can also use the Basler pylon Viewer application to easily set the parameters.

# 12 Technical Support

This chapter outlines the resources available to you if you need help working with your camera.

## 12.1 Technical Support Resources

If you need advice about your camera or if you need assistance troubleshooting a problem with your camera, you can contact the Basler technical support team for your area. Basler technical support contact information is located in the front pages of this manual.

You will also find helpful information such as frequently asked questions, downloads, and application notes in the Support section of the Basler website: [www.baslerweb.com](http://www.baslerweb.com)

If you do decide to contact Basler technical support, please take a look at the form that appears on the last two pages of this section before you call. Filling out this form will help make sure that you have all of the information the Basler technical support team needs to help you with your problem.

## 12.2 Obtaining an RMA Number

Whenever you want to return material to Basler, you must request a Return Material Authorization (RMA) number before sending it back. The RMA number **must** be stated in your delivery documents when you ship your material to us! Please be aware that if you return material without an RMA number, we reserve the right to reject the material.

You can find detailed information about how to obtain an RMA number in the Support section of our website: [www.baslerweb.com](http://www.baslerweb.com)

## 12.3 Before Contacting Basler Technical Support

To help you as quickly and efficiently as possible when you have a problem with a Basler camera, it is important that you collect several pieces of information before you contact Basler technical support.

Copy the form that appears on the next two pages, fill it out, and fax the pages to your local dealer or to your nearest Basler support center. Or, you can send an e-mail listing the requested pieces of information and with the requested files attached. Basler technical support contact information is shown in the title section of this manual.



- 1 The camera's product ID: \_\_\_\_\_
- 2 The camera's serial number: \_\_\_\_\_
- 3 Network adapter that you use with the camera: \_\_\_\_\_
- 4 Describe the problem in as much detail as possible:  
(If you need more space, use an extra sheet of paper.)  
\_\_\_\_\_  
\_\_\_\_\_
- 5 If known, what's the cause of the problem?  
\_\_\_\_\_  
\_\_\_\_\_

- 6 When did the problem occur?  
 After start.                       While running.  
 After a certain action (e.g., a change of parameters):  
\_\_\_\_\_  
\_\_\_\_\_  
  
\_\_\_\_\_

- 7 How often did/does the problem occur?  
 Once.                                       Every time.  
 Regularly when:  
\_\_\_\_\_  
 Occasionally when:  
\_\_\_\_\_  
\_\_\_\_\_  
\_\_\_\_\_

- 8 How severe is the problem?  
 Camera can still be used.  
 Camera can be used after I take this action:  
\_\_\_\_\_  
\_\_\_\_\_  
 Camera can no longer be used.

- 9 Did your application ever run without problems?  Yes  No

10 Parameter set

It is very important for Basler technical support to get a copy of the exact camera parameters that you were using when the problem occurred.

To make note of the parameters, use the Basler pylon Viewer.

Select *Camera* menu > *Save Features...* command.

All feature settings are then saved as a text file in a pylon Feature Stream file (\*.pfs).

If you cannot access the camera, please try to state the following parameter settings:

- Image Size (AOI): \_\_\_\_\_
- Pixel Format: \_\_\_\_\_
- Packet Size: \_\_\_\_\_
- Exposure Time: \_\_\_\_\_
- Frame Rate: \_\_\_\_\_

11 Live image/test image

If you are having an image problem, try to generate and save live images that show the problem. Also generate and save test images. Please save the images in BMP format, zip them, and send them to Basler technical support.

# Appendix A

## Basler Network Drivers and Parameters

This section describes the Basler network drivers available for your camera and provides detailed information about the parameters associated with the drivers.

Two network drivers are available for the network adapter used with your GigE cameras:

- The **Basler filter driver** is a basic GigE Vision network driver that is compatible with all network adapters. The advantage of this driver is its extensive compatibility.
- The **Basler performance driver** is a hardware specific GigE Vision network driver. The driver is only compatible with network adapters that use specific Intel chipsets. The advantage of the performance driver is that it significantly lowers the CPU load needed to service the network traffic between the PC and the camera(s). It also has a more robust packet resend mechanism.



During the installation process you should have installed either the filter driver or the performance driver.

See the *Installation and Setup Guide for Cameras Used with Basler's pylon API (AW000611)*, for the following information:

- Information about compatible Intel chipsets
- Information about installing the network drivers

## A.1 The Basler Filter Driver

The Basler filter driver is a basic driver GigE Vision network driver. It is designed to be compatible with most network adapter cards.

The functionality of the filter driver is relatively simple. For each frame, the driver checks the order of the incoming packets. If the driver detects that a packet or a group of packets is missing, it will wait for a specified period of time to see if the missing packet or group of packets arrives. If the packet or group does not arrive within the specified period, the driver will send a resend request for the missing packet or group of packets.

The parameters associated with the filter driver are described below.

**Enable Resend** - Enables or disables the packet resend mechanism.

If packet resend is disabled and the filter driver detects that a packet has been lost during transmission, the grab result for the returned buffer holding the image will indicate that the grab failed and the image will be incomplete.

If packet resend is enabled and the driver detects that a packet has been lost during transmission, the driver will send a resend request to the camera. If the camera still has the packet in its buffer, it will resend the packet. If there are several lost packets in a row, the resend requests will be combined.

**Packet Timeout** - The Packet Timeout parameter defines how long (in milliseconds) the filter driver will wait for the next expected packet before it initiates a resend request. Make sure the Packet Timeout parameter is set to a longer time interval than the time interval set for the inter-packet delay.

**Frame Retention** - The Frame Retention parameter sets the timeout (in milliseconds) for the frame retention timer. Whenever the filter driver detects the leader for a frame, the frame retention timer starts. The timer resets after each packet in the frame is received and will timeout after the last packet is received. If the timer times out at any time before the last packet is received, the buffer for the frame will be released and will be indicated as an unsuccessful grab.

You can set the filter driver parameter values from within your application software by using the Basler pylon API. The following code snippet illustrates using the API to read and write the parameter values:

```
// Enable Resend
Camera_t::StreamGrabber_t StreamGrabber ( Camera.GetStreamGrabber(0) );
StreamGrabber.EnableResend.SetValue(false); // disable resends

// Packet Timeout/FrameRetention
Camera_t::StreamGrabber_t StreamGrabber ( Camera.GetStreamGrabber(0) );
StreamGrabber.PacketTimeout.SetValue( 40 );
StreamGrabber.FrameRetention.SetValue( 200 );
```

You can also use the Basler pylon Viewer application to easily set the parameters.

For more information about the pylon API and the pylon Viewer, see Section 3 on [page 21](#).

## A.2 The Basler Performance Driver

The Basler performance driver is a hardware specific GigE Vision network driver compatible with network adapters that use specific Intel chipsets. The main advantage of the performance driver is that it significantly lowers the CPU load needed to service the network traffic between the PC and the camera(s). It also has a more robust packet resend mechanism.

For more information about compatible Intel chipsets, see the *Installation and Setup Guide for Cameras Used with Basler's pylon API* (AW000611).

The performance driver uses two distinct "resend mechanisms" to trigger resend requests for missing packets:

- The threshold resend mechanism
- The timeout resend mechanism

The mechanisms are independent from each other and can be used separately. However, for maximum efficiency and for ensuring that resend requests will be sent for all missing packets, we recommend using both resend mechanisms in a specific, optimized combination, as provided by the parameter default values.

The performance driver's parameter values determine how the resend mechanisms act and how they relate to each other. You can set the parameter values by using the pylon Viewer or from within your application software by using the pylon API.



The parameter default values will provide for the following:

- The threshold resend mechanism precedes the timeout resend mechanism. This ensures that a resend request is sent for every missing packet, even at very high rates of arriving packets.
- The timeout resend mechanism will be effective for those missing packets that were not resent after the first resend request.

**We strongly recommend using the default parameter settings.** Only users with the necessary expertise should change the default parameter values.

The Basler performance driver uses a "receive window" to check the status of packets. The check for missing packets is made as packets enter the receive window. If a packet arrives from higher in the sequence of packets than expected, the preceding skipped packet or packets are detected as missing. For example, suppose packet (n-1) has entered the receive window and is immediately followed by packet (n+1). In this case, as soon as packet (n+1) enters the receive window, packet n will be detected as missing.

## A.2.1 General Parameters

**Enable Resend** - Enables the packet resend mechanisms.

If the Enable Resend parameter is set to false, the resend mechanisms are disabled. The performance driver will not check for missing packets and will not send resend requests to the camera.

If the Enable Resend parameter is set to true, the resend mechanisms are enabled. The performance driver will check for missing packets. Depending on the parameter settings and the resend response, the driver will send one or several resend requests to the camera.

**Receive Window Size** - Sets the size of the receive window.

## A.2.2 Threshold Resend Mechanism Parameters

The threshold resend request mechanism is illustrated in Figure 66 where the following assumptions are made:

- Packets 997, 998, and 999 are missing from the stream of packets.
- Packet 1002 is missing from the stream of packets.

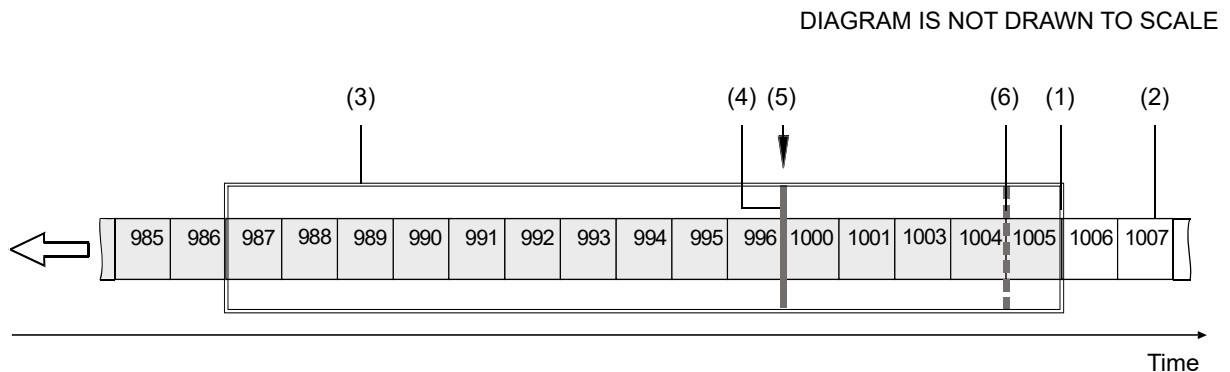

Fig. 66: Example of a Receive Window with Resend Request Threshold & Resend Request Batching Threshold

- (1) Front end of the receive window. Missing packets are detected here.
- (2) Stream of packets. Gray indicates that the status was checked as the packet entered the receive window. White indicates that the status has not yet been checked.
- (3) Receive window of the performance driver.
- (4) Threshold for sending resend requests (resend request threshold).
- (5) A separate resend request is sent for each packets 997, 998, and 999.
- (6) Threshold for batching resend requests for consecutive missing packets (resend request batching threshold). Only one resend request will be sent for the consecutive missing packets.

**Resend Request Threshold** - This parameter determines the location of the resend request threshold within the receive window as shown in Figure 66. The parameter value is in per cent of the width of the receive window. In Figure 66 the resend request threshold is set at 33.33% of the width of the receive window.

A stream of packets advances packet by packet beyond the resend request threshold (i.e. to the left of the resend request threshold in Figure 66). As soon as the position where a packet is missing advances beyond the resend request threshold, a resend request is sent for the missing packet.

In the example shown in Figure 66, packets 987 to 1005 are within the receive window and packets 997 to 999 and 1002 were detected as missing. In the situation shown, a resend request is sent to the camera for each of the missing consecutive packets 997 to 999. The resend requests are sent after packet 996 - the last packet of the intact sequence of packets - has advanced beyond the resend request threshold and before packet 1000 - the next packet in the stream of packets - can advance beyond the resend request threshold. Similarly, a resend request will be sent for missing packet 1002 after packet 1001 has advanced beyond the resend request threshold and before packet 1003 can advance beyond the resend request threshold.

**Resend Request Batching** - This parameter determines the location of the resend request batching threshold in the receive window (Figure 66). The parameter value is in per cent of a span that starts with the resend request threshold and ends with the front end of the receive window. The maximum allowed parameter value is 100. In Figure 66 the resend request batching threshold is set at 80% of the span.

The resend request batching threshold relates to consecutive missing packets, i.e., to a continuous sequence of missing packets. Resend request batching allows grouping of consecutive missing packets for a single resend request rather than sending a sequence of resend requests where each resend request relates to just one missing packet.

The location of the resend request batching threshold determines the maximum number of consecutive missing packets that can be grouped together for a single resend request. The maximum number corresponds to the number of packets that fit into the span between the resend request threshold and the resend request batching threshold plus one.

If the Resend Request Batching parameter is set to 0, no batching will occur and a resend request will be sent for each single missing packet. For other settings, consider an example: Suppose the Resend Request Batching parameter is set to 80 referring to a span between the resend request threshold and the front end of the receive window that can hold five packets (Figure 66). In this case 4 packets ( $5 \times 80\%$ ) will fit into the span between the resend request threshold and the resend request batching threshold. Accordingly, the maximum number of consecutive missing packets that can be batched is 5 ( $4 + 1$ ).

## A.2.3 Timeout Resend Mechanism Parameters

The timeout resend mechanism is illustrated in Figure 67 where the following assumptions are made:

- The frame includes 3000 packets.
- Packet 1002 is missing within the stream of packets and has not been recovered.
- Packets 2999 and 3000 are missing at the end of the stream of packets (end of the frame).
- The Maximum Number Resend Requests parameter is set to 3.

DIAGRAM IS NOT DRAWN TO SCALE

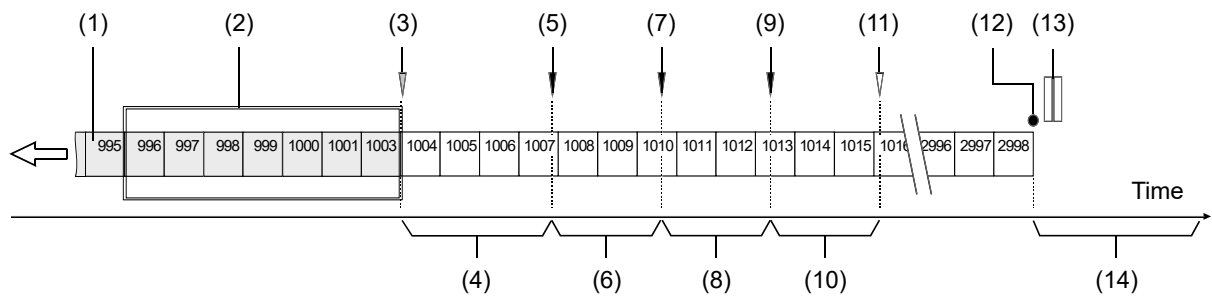

Fig. 67: Incomplete Stream of Packets and Part of the Resend Mechanism

- (1) Stream of packets. Gray indicates that the status was checked as the packet entered the receive window. White indicates that the status has not yet been checked.
- (2) Receive window of the performance driver.
- (3) As packet 1003 enters the receive window, packet 1002 is detected as missing.
- (4) Interval defined by the Resend Timeout parameter.
- (5) The Resend Timeout interval expires and the first resend request for packet 1002 is sent to the camera. The camera does not respond with a resend.
- (6) Interval defined by the Resend Response Timeout parameter.
- (7) The Resend Response Timeout interval expires and a second resend request for packet 1002 is sent to the camera. The camera does not respond with a resend.
- (8) Interval defined by the Resend Response Timeout parameter.
- (9) The Resend Response Timeout interval expires and a third resend request for packet 1002 is sent to the camera. The camera still does not respond with a resend.
- (10) Interval defined by the Resend Response Timeout parameter.
- (11) Because the maximum number of resend requests has been sent and the last Resend Response Timeout interval has expired, packet 1002 is now considered as lost.
- (12) End of the frame.
- (13) Missing packets at the end of the frame (2999 and 3000).
- (14) Interval defined by the Packet Timeout parameter.



**Maximum Number Resend Requests** - The Maximum Number Resend Requests parameter sets the maximum number of resend requests the performance driver will send to the camera for each missing packet.

**Resend Timeout** - The Resend Timeout parameter defines how long (in milliseconds) the performance driver will wait after detecting that a packet is missing before sending a resend request to the camera. The parameter applies only once to each missing packet after the packet was detected as missing.

**Resend Request Response Timeout** - The Resend Request Response Timeout parameter defines how long (in milliseconds) the performance driver will wait after sending a resend request to the camera before considering the resend request as lost.

If a resend request for a missing packet is considered lost and if the maximum number of resend requests as set by the Maximum Number Resend Requests parameter has not yet been reached, another resend request will be sent. In this case, the parameter defines the time separation between consecutive resend requests for a missing packet.

**Packet Timeout** - The Packet Timeout parameter defines how long (in milliseconds) the performance driver will wait for the next expected packet before it sends a resend request to the camera. This parameter ensures that resend requests are sent for missing packets near to the end of a frame. In the event of a major interruption in the stream of packets, the parameter will also ensure that resend requests are sent for missing packets that were detected to be missing immediately before the interruption. Make sure the Packet Timeout parameter is set to a longer time interval than the time interval set for the inter-packet delay.

## A.2.4 Threshold and Timeout Resend Mechanisms Combined

Figure 68 illustrates the combined action of the threshold and the timeout resend mechanisms where the following assumptions are made:

- All parameters set to default.
- The frame includes 3000 packets.
- Packet 1002 is missing within the stream of packets and has not been recovered.
- Packets 2999 and 3000 are missing at the end of the stream of packets (end of the frame).

The default values for the performance driver parameters will cause the threshold resend mechanism to become operative before the timeout resend mechanism. This ensures maximum efficiency and that resend requests will be sent for all missing packets.

With the default parameter values, the resend request threshold is located very close to the front end of the receive window. Accordingly, there will be only a minimum delay between detecting a missing packet and sending a resend request for it. In this case, a delay according to the Resend Timeout parameter will not occur (see Figure 68). In addition, resend request batching will not occur.

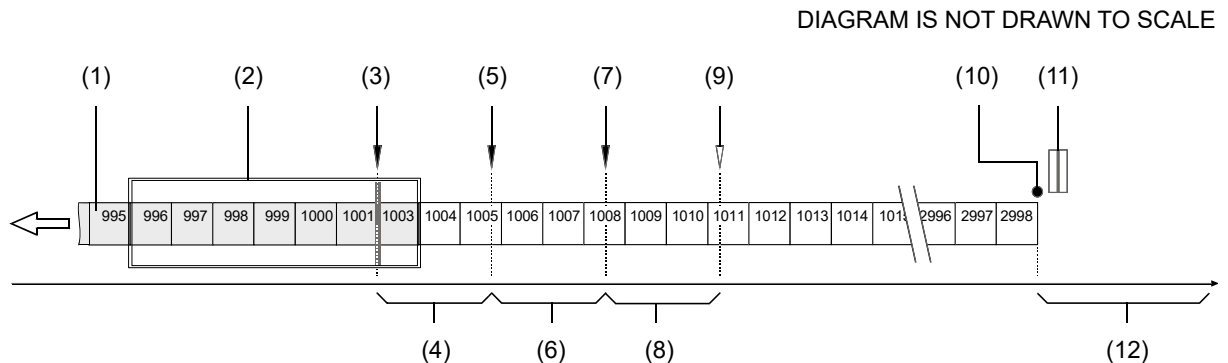

Fig. 68: Combination of Threshold Resend Mechanism and Timeout Resend Mechanism

- (1) Stream of packets, Gray indicates that the status was checked as the packet entered the receive window. White indicates that the status has not yet been checked.
- (2) Receive window of the performance driver.
- (3) Threshold for sending resend requests (resend request threshold). The first resend request for packet 1002 is sent to the camera. The camera does not respond with a resend.
- (4) Interval defined by the Resend Response Timeout parameter.
- (5) The Resend Timeout interval expires and the second resend request for packet 1002 is sent to the camera. The camera does not respond with a resend.
- (6) Interval defined by the Resend Response Timeout parameter
- (7) The Resend Timeout interval expires and the third resend request for packet 1002 is sent to the camera. The camera does not respond with a resend.

- (8) Interval defined by the Resend Response Timeout parameter
- (9) Because the maximum number of resend requests has been sent and the last Resend Response Timeout interval has expired, packet 1002 is now considered as lost.
- (10) End of the frame.
- (11) Missing packets at the end of the frame (2999 and 3000).
- (12) Interval defined by the Packet Timeout parameter.

You can set the performance driver parameter values from within your application software by using the Basler pylon API. The following code snippet illustrates using the API to read and write the parameter values:

```
// Get the Stream Parameters object
Camera_t::StreamGrabber_t StreamGrabber( Camera.GetStreamGrabber(0) );

// Write the ReceiveWindowSize parameter
StreamGrabber.ReceiveWindowSize.SetValue( 16 );

// Disable packet resends
StreamGrabber.EnableResend.SetValue( false );

// Write the PacketTimeout parameter
StreamGrabber.PacketTimeout.SetValue( 40 );

// Write the ResendRequestThreshold parameter
StreamGrabber.ResendRequestThreshold.SetValue( 5 );

// Write the ResendRequestBatching parameter
StreamGrabber.ResendRequestBatching.SetValue( 10 );

// Write the ResendTimeout parameter
StreamGrabber.ResendTimeout.SetValue( 2 );

// Write the ResendRequestResponseTimeout parameter
StreamGrabber.ResendRequestResponseTimeout.SetValue( 2 );

// Write the MaximumNumberResendRequests parameter
StreamGrabber.MaximumNumberResendRequests.SetValue( 25 );
```

You can also use the Basler pylon Viewer application to easily set the parameters. (Note that the performance driver parameters will only appear in the viewer if the performance driver is installed on the adapter to which your camera is connected.)

For more information about the pylon API and the pylon Viewer, see Section 3 on [page 21](#).

## A.2.5 Adapter Properties

When the Basler Performance driver is installed, it adds a set of "advanced" properties to the network adapter. These properties include:

**Max Packet Latency** - A value in microseconds that defines how long the adapter will wait after it receives a packet before it generates a packet received interrupt.

**Max Receive Inter-packet Delay** - A value in microseconds that defines the maximum amount of time allowed between incoming packets.

**Maximum Interrupts per Second** - Sets the maximum number of interrupts per second that the adapter will generate.

**Network Address** - allows the user to specify a MAC address that will override the default address provided by the adapter.

**Packet Buffer Size** - Sets the size in bytes of the buffers used by the receive descriptors and the transmit descriptors.

**Receive Descriptors** - Sets the number of descriptors to use in the adapter's receiving ring.

**Transmit Descriptors** - Sets the number of descriptors to use in the adapter's transmit ring.

To access the advanced properties for an adapter:

1. Open a **Network Connections** window and find the connection for your network adapter.
2. Right click on the name of the connection and select **Properties** from the drop down menu.
3. A **LAN Connection Properties** window will open. Click the **Configure** button.
4. An **Adapter Properties** window will open. Click the **Advanced** tab.



**We strongly recommend using the default parameter settings.** Changing the parameters can have a significant negative effect on the performance of the adapter and the driver.

## A.2.6 Transport Layer Parameters

The transport layer parameters are part of the camera's basic GigE implementation. These parameters do not normally require adjustment.

**Read Timeout** - If a register read request is sent to the camera via the transport layer, this parameter designates the time out (in milliseconds) within which a response must be received.

**Write Timeout** - If a register write request is sent to the camera via the transport layer, this parameter designates the time out (in milliseconds) within which an acknowledge must be received.

**Heartbeat Timeout** - The GigE Vision standard requires implementation of a heartbeat routine to monitor the connection between the camera and the host PC. This parameter sets the heartbeat timeout (in milliseconds). If a timeout occurs, the camera releases the network connection and enters a state that allows reconnection.



Management of the heartbeat time is normally handled by the Basler's basic GigE implementation and changing this parameter is not required for normal camera operation. However, if you are debugging an application and you stop at a break point, you will have a problem with the heartbeat timer. The timer will time out when you stop at a break point and the connection to the camera will be lost. When debugging, you should increase the heartbeat timeout to a high value to avoid heartbeat timeouts at break points. When debugging is complete, you should return the timeout to its normal setting.

You can set the driver related transport layer parameter values from within your application software by using the Basler pylon API. The following code snippet illustrates using the API to read and write the parameter values:

```
// Read/Write Timeout
Camera_t::TlParams_t TlParams( Camera.GetTLNodeMap() );
TlParams.ReadTimeout.SetValue(500); // 500 milliseconds
TlParams.WriteTimeout.SetValue(500); // 500 milliseconds

// Heartbeat Timeout
Camera_t::TlParams_t TlParams( Camera.GetTLNodeMap() );
TlParams.HeartbeatTimeout.SetValue(5000); // 5 seconds
```

You can also use the Basler pylon Viewer application to easily set the parameters.

For more information about the pylon API and the pylon Viewer, see Section 3 on [page 21](#).

# Appendix B

## Network Related Camera Parameters and Managing Bandwidth

This section describes the camera parameters that are related to the camera's performance on the network. It also describes how to use the parameters to manage the available network bandwidth when you are using multiple cameras.

### B.1 Network Related Parameters in the Camera

The camera includes several parameters that determine how it will use its network connection to transmit data to the host PC. The list below describes each parameter and provides basic information about how the parameter is used. The following section describes how you can use the parameters to manage the bandwidth used by each camera on your network.

#### **Payload Size** (read only)

Indicates the total size in bytes of the image data plus any chunk data (if chunks are enabled) that the camera will transmit. Packet headers are not included.

#### **Stream Channel Selector** (read/write)

The GigE Vision standard specifies a mechanism for establishing several separate stream channels between the camera and the PC. This parameter selects the stream channel that will be affected when the other network related parameters are changed.

Currently, the cameras support only one stream channel, i.e., stream channel 0.

#### **Packet Size** (read/write)

As specified in the GigE Vision standard, each acquired image will be fit into a data block. The block contains three elements: a *data leader* consisting of one packet used to signal the beginning of a data block, the *data payload* consisting of one or more packets containing the actual data for the current block, and a *data trailer* consisting of one packet used to signal the end of the data block.

The packet size parameter sets the size of the packets that the camera will use when it sends the data payload via the selected stream channel. The value is in bytes. The value does not affect the

leader and trailer size using a total of 36 bytes, and the last data packet may be a smaller size. The payload size will be packet size minus 36 bytes.

The packet size parameter should always be set to the maximum size that your network adapter and network switches (if used) can handle.

#### **Inter-packet Delay** (read/write)

Sets the delay in ticks between the packets sent by the camera. Applies to the selected stream channel. Increasing the inter-packet delay will decrease the camera's effective data transmission rate and will thus decrease the network bandwidth used by the camera.

In the current camera implementation, one tick = 8 ns. To check the tick frequency, you can read the Gev Timestamp Tick Frequency parameter value. This value indicates the number of clock ticks per second.

When setting the time interval for the inter-packet delay, make sure that the time interval for the packet timeout is set to a higher value.

#### **Frame Transmission Delay** (read/write)

Sets a delay in ticks (one tick = 8 ns) between when a camera would normally begin transmitting an acquired frame and when it actually begins transmission. This parameter should be set to zero in most normal situations.

If you have many cameras in your network and you will be simultaneously triggering image acquisition on all of them, you may find that your network switch or network adapter is overwhelmed if all of the cameras simultaneously begin to transmit image data at once. The frame transmission delay parameter can be used to stagger the start of image data transmission from each camera.

#### **Bandwidth Assigned** (read only)

Indicates the bandwidth in bytes per second that will be used by the camera to transmit image and chunk feature data and to handle resends and control data transmissions. The value of this parameter is a result of the packet size and the inter-packet delay parameter settings.

In essence, the bandwidth assigned is calculated this way:

$$\text{Bandwidth Assigned} = \frac{\frac{X \text{ Packets}}{\text{Frame}} \times \frac{Y \text{ Bytes}}{\text{Packet}}}{\left[ \frac{X \text{ Packets}}{\text{Frame}} \times \frac{Y \text{ Bytes}}{\text{Packet}} \times \frac{8 \text{ ns}}{\text{Byte}} \right] + \left[ \left( \frac{X \text{ Packets}}{\text{Frame}} - 1 \right) \times (\text{IPD} \times 8 \text{ ns}) \right]}$$

Where: X = number of packets needed to transmit the frame

Y = number of bytes in each packet

IPD = Inter-packet Delay setting in ticks (with a tick set to the 8 ns standard)

When considering this formula, you should know that on a Gigabit network it takes one tick to transmit one byte. Also, be aware that the formula has been simplified for easier understanding.

**Bandwidth Reserve** (read/write)

Used to reserve a portion of the assigned bandwidth for packet resends and for the transmission of control data between the camera and the host PC. The setting is expressed as a percentage of the Bandwidth Assigned parameter. For example, if the Bandwidth Assigned parameter indicates that 30 MByte/s have been assigned to the camera and the Bandwidth Reserve parameter is set to 5%, then the bandwidth reserve will be 1.5 MByte/s.

**Bandwidth Reserve Accumulation** (read/write)

A software device called the bandwidth reserve accumulator is designed to handle unusual situations such as a sudden EMI burst that interrupts an image transmission. If this happens, a larger than normal number of packet resends may be needed to properly transmit a complete image. The accumulator is basically an extra pool of resends that the camera can use in unusual situations.

The Bandwidth Reserve Accumulation parameter is a multiplier used to set the maximum number of resends that can be held in the "accumulator pool." For example, assume that the current bandwidth reserve setting for your camera is 5% and that this reserve is large enough to allow up to 5 packet resends during a frame period. Also assume that the Bandwidth Reserve Accumulation parameter is set to 3. With these settings, the accumulator pool can hold a maximum of 15 resends (i.e., the multiplier times the maximum number of resends that could be transmitted in a frame period). Note that with these settings, 15 will also be the starting number of resends within the accumulator pool.

The chart on the next page and the numbered text below it show an example of how the accumulator would work with these settings. The chart and the text assume that you are using an external trigger to trigger image acquisition. The example also assumes that the camera is operating in a poor environment, so many packets are lost and many resends are required. The numbered text is keyed to the time periods in the chart.



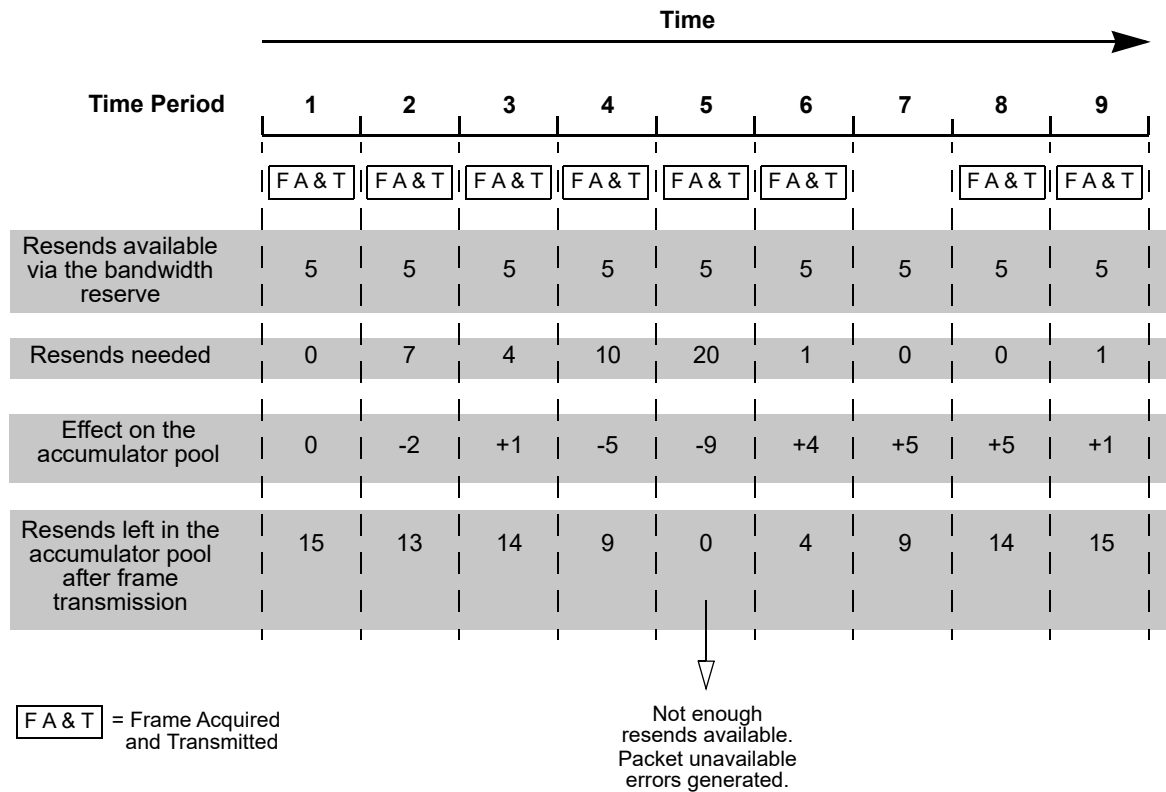

- (1) You trigger image acquisition and during this time period, the camera acquires and transmits a frame. The bandwidth reserve setting would allow 5 resends during this time period, but no resends are needed. The accumulator pool started with 15 resends available and remains at 15.
- (2) You trigger image acquisition and during this time period, the camera acquires and transmits a frame. The bandwidth reserve setting would allow 5 resends during this time period, but 7 resends are needed. The 5 resends available via the bandwidth reserve are used and 2 resends are used from the accumulator pool. The accumulator pool is drawn down to 13.
- (3) You trigger image acquisition and during this time period, the camera acquires and transmits a frame. The bandwidth reserve setting would allow 5 resends during this time period and 4 resends are needed. The 4 resends needed are taken from the resends available via the bandwidth reserve. The fifth resend available via the bandwidth reserve is not needed, so it is added to the accumulator pool and brings the pool to 14.
- (4) You trigger image acquisition and during this time period, the camera acquires and transmits a frame. The bandwidth reserve setting would allow 5 resends during this time period, but 10 resends are needed. The 5 resends available via the bandwidth reserve are used and 5 resends are used from the accumulator pool. The accumulator pool is drawn down to 9.
- (5) You trigger image acquisition and during this time period, the camera acquires and transmits a frame. The bandwidth reserve setting would allow 5 resends during this time period, but 20 resends are needed. The 5 resends available via the bandwidth reserve are used. To complete all of the needed resends, 15 resends would be required from the accumulator pool, but the pool only has 9 resends. So the 9 resends in the pool are used and 6 resend requests are answered with a "packet unavailable" error code. The accumulator pool is reduced to 0.

- (6) You trigger image acquisition and during this time period, the camera acquires and transmits a frame. The bandwidth reserve setting would allow 5 resends during this time period and 1 resend is needed. The 1 resend needed is taken from the resends available via the bandwidth reserve. The other 4 resends available via the bandwidth reserve are not needed, so they are added to the accumulator pool and they bring the pool up to 4.
- (7) During this time period, you do not trigger image acquisition. You delay triggering acquisition for the period of time that would normally be needed to acquire and transmit a single image. The current camera settings would allow 5 resends to occur during this period of time. But since no data is transmitted, no resends are required. The 5 resends that could have occurred are added to the accumulator pool and they bring the pool up to 9.
- (8) You trigger image acquisition and during this time period, the camera acquires and transmits a frame. The bandwidth reserve setting would allow 5 resends during this time period, but no resends are needed. The 5 resends available via the bandwidth reserve are not needed, so they are added to the accumulator pool and they bring the pool up to 14.
- (9) You trigger image acquisition and during this time period, the camera acquires and transmits a frame. The bandwidth reserve setting would allow 5 resends during this time period and 1 resend is needed. The 1 resend needed is taken from the resends available via the bandwidth reserve. The other 4 resends available via the bandwidth reserve are not needed, so they are added to the accumulator pool. Note that with the current settings, the accumulator pool can only hold a maximum of 15 resends. So the pool is now 15.

#### **Frame Max Jitter** (read only)

If the Bandwidth Reserve Accumulation parameter is set to a high value, the camera can experience a large burst of data resends during transmission of a frame. This burst of resends will delay the start of transmission of the next acquired frame. The Frame Max Jitter parameter indicates the maximum time in ticks (one tick = 8 ns) that the next frame transmission could be delayed due to a burst of resends.

#### **Device Max Throughput** (read only)

Indicates the maximum amount of data (in bytes per second) that the camera could generate given its current settings and an ideal world. This parameter gives no regard to whether the GigE network has the capacity to carry all of the data and does not consider any bandwidth required for resends. In essence, this parameter indicates the maximum amount of data the camera could generate with no network restrictions.

If the Acquisition Frame Rate abs parameter has been used to set the camera's frame rate, the camera will use this frame rate setting to calculate the device max throughput. If software or hardware triggering is being used to control the camera's frame rate, the maximum frame rate allowed with the current camera settings will be used to calculate the device max throughput.

**Device Current Throughput** (read only)

Indicates the actual bandwidth (in bytes per second) that the camera will use to transmit image data and chunk data given the current area of interest settings, chunk feature settings, and the pixel format setting.

If the Acquisition Frame Rate abs parameter has been used to set the camera's frame rate, the camera will use this frame rate setting to calculate the device current throughput. If software or hardware triggering is being used to control the camera's frame rate, the maximum frame rate allowed with the current camera settings will be used to calculate the device current throughput.

Note that the Device Current Throughput parameter indicates the bandwidth needed to transmit the actual image data and chunk data. The Bandwidth Assigned parameter, on the other hand, indicates the bandwidth needed to transmit image data and chunk data plus the bandwidth reserved for retries and the bandwidth needed for any overhead such as leaders and trailers.

**Resulting Frame Rate** (read only)

Indicates the maximum allowed frame acquisition rate (in frames per second) given the current camera settings. The parameter takes the current area of interest, exposure time, and bandwidth settings into account.

If the Acquisition Frame Rate abs parameter has been used to set the camera's frame rate, the Resulting Frame Rate parameter will show the Acquisition Frame Rate abs parameter setting. If software or hardware triggering is being used to control the camera's frame rate, the Resulting Frame Rate parameter will indicate the maximum frame rate allowed given the current camera settings.

You can read or set the camera's network related parameter values from within your application software by using the Basler pylon API. The following code snippet illustrates using the API to set the selector and the parameter values:

```
// Payload Size
int64_t payloadSize = Camera.PayloadSize.GetValue();

// GevStreamChannelSelector
Camera.GevStreamChannelSelector.SetValue
( GevStreamChannelSelector_StreamChannel0 );

// PacketSize
Camera.GevSCPSPacketSize.SetValue( 1500 );

// Inter-packet Delay
Camera.GevSCPD.SetValue( 1000 );

// Frame-transmission Delay
Camera.GevSCFTD.SetValue( 1000 );

// Bandwidth Reserve
Camera.GevSCBWR.SetValue( 10 );
```

```
// Bandwidth Reserve Accumulation
Camera.GevSCBWRA.SetValue( 10 );

// Frame Jitter Max
int64_t jitterMax = Camera.GevSCFJM.GetValue();

// Device Max Throughput
int64_t maxThroughput = Camera.GevSCDMT.GetValue();

// Device Current Throughput
int64_t currentThroughput = Camera.GevSCDCT.GetValue();

// Resulting Frame Rate
double resultingFps = Camera.ResultingFrameRateAbs.GetValue();
```

You can also use the Basler pylon Viewer application to easily set or view the parameter values.

For more information about the pylon API and the pylon Viewer, see Section 3 on [page 21](#).

## B.2 Managing Bandwidth When Multiple Cameras Share a Single Network Path



Because a single aviator GigE camera operating at full resolution and a high frame rate uses almost 100% of the bandwidth available on a GigE network path, this section does not generally apply to aviator cameras. However, if you are operating aviator cameras with small AOIs and at reduced frame rates, it may be possible to have multiple cameras on a single path. In that case, the information in this section would be helpful.

If you are using a single camera on a GigE network, the problem of managing bandwidth is simple. The network can easily handle the bandwidth needs of a single camera and no intervention is required. A more complicated situation arises if you have multiple cameras connected to a single network adapter as shown in Figure 69.

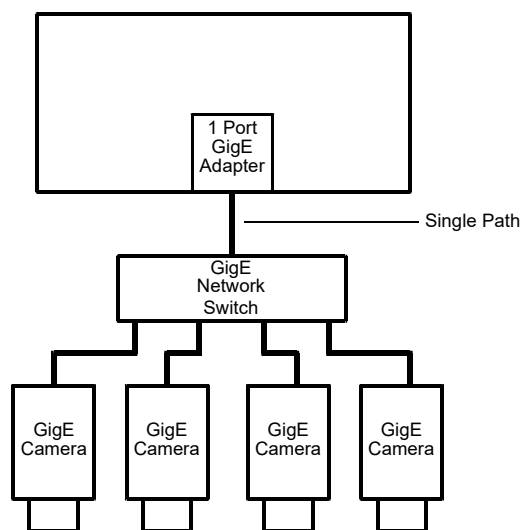

Fig. 69: Multiple Cameras on a Network

One way to manage the situation where multiple cameras are sharing a single network path is to make sure that only one of the cameras is acquiring and transmitting images at any given time. The data output from a single camera is well within the bandwidth capacity of the single path and you should have no problem with bandwidth in this case.

If you want to acquire and transmit images from several cameras simultaneously, however, you must determine the total data output rate for all the cameras that will be operating simultaneously and you must make sure that this total does not exceed the bandwidth of the single path (125 MByte/s).

An easy way to make a quick check of the total data output from the cameras that will operate simultaneously is to read the value of the Bandwidth Assigned parameter for each camera. This parameter indicates the camera's gross data output rate in bytes per second with its current settings. If the sum of the bandwidth assigned values is less than 125 MByte/s, the cameras should be able to operate simultaneously without problems. If it is greater, you must lower the data output rate of one or more of the cameras.

You can lower the data output rate on a camera by using the Inter-packet Delay parameter. This parameter adds a delay between the transmission of each packet from the camera and thus slows the data transmission rate of the camera. The higher the inter-packet delay parameter is set, the greater the delay between the transmission of each packet will be and the lower the data transmission rate will be. After you have adjusted the Inter-packet Delay parameter on each camera, you can check the sum of the Bandwidth Assigned parameter values and see if the sum is now less than 125 MByte/s.

## B.3 A Procedure for Managing Bandwidth

In theory, managing bandwidth sharing among several cameras is as easy as adjusting the inter-packet delay. In practice, it is a bit more complicated because you must consider several factors when managing bandwidth. The procedure below outlines a structured approach to managing bandwidth for several cameras.

The objectives of the procedure are:

- To optimize network performance.
- To determine the bandwidth needed by each camera for image data transmission.
- To determine the bandwidth actually assigned to each camera for image data transmission.
- For each camera, to make sure that the actual bandwidth assigned for image data transmission matches the bandwidth needed.
- To make sure that the total bandwidth assigned to all cameras does not exceed the network's bandwidth capacity.
- To make adjustments if the bandwidth capacity is exceeded.

### Step 1 - Improve the Network Performance.

If you use, as recommended, the Basler performance driver with an Intel PRO network adapter or a compatible network adapter, the network parameters for the network adapter are automatically optimized and need not be changed.

If you use the Basler filter driver and have already set network parameters for your network adapter during the installation of the Basler pylon software, continue with step two. Otherwise, open the **Network Connection Properties** window for your network adapter and check the following network parameters:

- If you use an Intel PRO network adapter: Make sure the **Receive Descriptors** parameter is set to its maximum value and the **Interrupt Moderation Rate** parameter is set to **Extreme**.

Also make sure the **Speed and Duplex Mode** parameter is set to **Auto Detect**.

- If you use a different network adapter, see whether parameters are available that will allow setting the number of receive descriptors and the number of CPU interrupts. The related parameter names may differ from the ones used for the Intel PRO adapters. Also, the way of setting the parameters may be different. You may, e.g., have to use a parameter to set a low number for the interrupt moderation and then use a different parameter to enable the interrupt moderation.

If possible, set the number of receive descriptors to a maximum value and set the number of CPU interrupts to a low value.

If possible, also set the parameter for speed and duplex to auto.

Contact Basler technical support if you need further assistance.

## Step 2 - Set the Packet Size parameter on each camera as large as possible.

Using the largest possible packet size has two advantages, it increases the efficiency of network transmissions between the camera and the PC and it reduces the time required by the PC to process incoming packets. The largest packet size setting that you can use with your camera is determined by the largest packet size that can be handled by your network. The size of the packets that can be handled by the network depends on the capabilities and settings of the network adapter you are using and on capabilities of the network switch you are using.

Unless you have already set the packet size for your network adapter during the installation of the Basler pylon software, check the documentation for your adapter to determine the maximum packet size (sometimes called "frame" size) that the adapter can handle. Many adapters can handle what is known as "jumbo packets" or "jumbo frames". These are packets with a maximum size of 16 kB. Once you have determined the maximum size packets the adapter can handle, make sure that the adapter is set to use the maximum packet size.

Next, check the documentation for your network switch and determine the maximum packet size that it can handle. If there are any settings available for the switch, make sure that the switch is set for the largest packet size possible.

Now that you have set the adapter and switch, you can determine the largest packet size the network can handle. The device with the smallest maximum packet size determines the maximum allowed packet size for the network. For example, if the adapter can handle 8 kB packets and the switch can handle 6 kB packets, then the maximum for the network is 6 kB packets.

Once you have determined the maximum packet size for your network, set the value of the Packet Size parameter on each camera to this value.



The manufacturer's documentation sometimes makes it difficult to determine the maximum packet size for a device, especially network switches. There is a "quick and dirty" way to check the maximum packet size for your network with its current configuration:

1. Open the pylon Viewer, select a camera, and set the Packet Size parameter to a low value (1 kB for example).
2. Use the Continuous Shot mode to capture several images.
3. Gradually increase the value of the Packet Size parameter and capture a few images after each size change.
4. When your Packet Size setting exceeds the packet size that the network can handle, the viewer will lose the ability to capture images. (When you use Continuous Shot, the viewer's status bar will indicate that it is acquiring images, but the image in the viewing area will appear to be frozen.)

## Step 3 - Set the Bandwidth Reserve parameter for each camera.

The Bandwidth Reserve parameter setting for a camera determines how much of the bandwidth assigned to that camera will be reserved for lost packet resends and for asynchronous traffic such as commands sent to the camera. If you are operating the camera in a relatively EMI free



environment, you may find that a bandwidth reserve of 2% or 3% is adequate. If you are operating in an extremely noisy environment, you may find that a reserve of 8% or 10% is more appropriate.

#### Step 4 - Calculate the "data bandwidth needed" by each camera.

The objective of this step is to determine how much bandwidth (in Byte/s) each camera needs to transmit the image data that it generates. The amount of data bandwidth a camera needs is the product of several factors: the amount of data included in each image, the amount of chunk data being added to each image, the "packet overhead" such as packet leaders and trailers, and the number of frames the camera is acquiring each second.

For each camera, you can use the two formulas below to calculate the data bandwidth needed. To use the formulas, you will need to know the current value of the Payload Size parameter and the Packet Size parameter for each camera. You will also need to know the frame rate (in frames/s) at which each camera will operate.

$$\text{Bytes/Frame} = \left[ \left\lceil \frac{\text{Payload Size}}{\text{Packet Size}} \right\rceil^1 \times \text{Packet Overhead} \right] + \lceil \text{Payload Size} \rceil^4 + \text{Leader Size} + \text{Trailer Size}$$

$$\text{Data Bandwidth Needed} = \text{Bytes/Frame} \times \text{Frames/s}$$

Where:

Packet Overhead = 72 (for a GigE network)

78 (for a 100 MBit/s network)

Leader Size = Packet Overhead + 36 (if chunk mode is not active)

Packet Overhead + 12 (if chunk mode is active)

Trailer Size = Packet Overhead + 8

$\lceil x \rceil^1$  means round up x to the nearest integer

$\lceil x \rceil^4$  means round up x to the nearest multiple of 4

#### Step 5 - Calculate "data bandwidth assigned" to each camera.

For each camera, there is a parameter called Bandwidth Assigned. This read only parameter indicates the total bandwidth that has been assigned to the camera. The Bandwidth Assigned parameter includes both the bandwidth that can be used for image data transmission plus the bandwidth that is reserved for packet resents and camera control signals. To determine the "data bandwidth assigned," you must subtract out the reserve.

You can use the formula below to determine the actual amount of assigned bandwidth that is available for data transmission. To use the formula, you will need to know the current value of the Bandwidth Assigned parameter and the Bandwidth reserve parameter for each camera.

$$\text{Data Bandwidth Assigned} = \text{Bandwidth Assigned} \times \frac{100 - \text{Bandwidth Reserved}}{100}$$

**Step 6 - For each camera, compare the data bandwidth needed with the data bandwidth assigned.**

For each camera, you should now compare the data bandwidth assigned to the camera (as determined in step 4) with the bandwidth needed by the camera (as determined in step 3).

For bandwidth to be used most efficiently, the data bandwidth assigned to a camera should be equal to or just slightly greater than the data bandwidth needed by the camera. If you find that this is the situation for all of the cameras on the network, you can go on to step 6 now. If you find a camera that has much more data bandwidth assigned than it needs, you should make an adjustment.

To lower the amount of data bandwidth assigned, you must adjust a parameter called the Inter-packet Delay. If you increase the Inter-packet Delay parameter value on a camera, the data bandwidth assigned to the camera will decrease. So for any camera where you find that the data bandwidth assigned is much greater than the data bandwidth needed, you should do this:

1. Raise the setting for the Inter-packet delay parameter for the camera.
2. Recalculate the data bandwidth assigned to the camera.
3. Compare the new data bandwidth assigned to the data bandwidth needed.
4. Repeat 1, 2, and 3 until the data bandwidth assigned is equal to or just greater than the data bandwidth needed.



If you increase the inter-packet delay to lower a camera's data output rate there is something that you must keep in mind. When you lower the data output rate, you increase the amount of time that the camera needs to transmit an acquired frame (image). Increasing the frame transmission time can restrict the camera's maximum allowed frame rate.

**Step 7 - Check that the total bandwidth assigned is less than the network capacity.**

1. For each camera, determine the current value of the Bandwidth Assigned parameter. The value is in Byte/s. (Make sure that you determine the value of the Bandwidth Assigned parameter after you have made any adjustments described in the earlier steps.)
2. Find the sum of the current Bandwidth Assigned parameter values for all of the cameras.

If the sum of the Bandwidth Assigned values is less than 125 MByte/s for a GigE network or 12.5 M/Byte/s for a 100 Bit/s network, the bandwidth management is OK.

If the sum of the Bandwidth Assigned values is greater than 125 MByte/s for a GigE network or 12.5 M/Byte/s for a 100 Bit/s network, the cameras need more bandwidth than is available and you must make adjustments. In essence, you must lower the data bandwidth needed by one or more of the cameras and then adjust the data bandwidths assigned so that they reflect the lower bandwidth needs.

You can lower the data bandwidth needed by a camera either by lowering its frame rate or by decreasing the size of the area of interest (AOI). Once you have adjusted the frame rates and/or AOI settings on the cameras, you should repeat steps 2 through 6.

For more information about

- the camera's maximum allowed frame transmission rate, see Section 7.9 on [page 93](#).
- the AOI, see Section 10.6 on [page 159](#).

## Revision History

Doc. ID Number	Date	Changes
AW00097601000	17 Dec 2010	Initial release of this document.
AW00097602000	20 Apr 2011	Initial release of this document for series production cameras.
AW00097603000	Oct 2011	<p>Indicated Basler AG as bearer of the copyright on the back of the front page.</p> <p>Added cable shield and AC In lines and Gnd to the power supply in Fig. 11 in Section 5.3.2 on <a href="#">page 32</a>.</p> <p>Changed the max. prelines setting for the avA1000-100gm/gc in Section 10.6.2 on <a href="#">page 162</a>.</p> <p>Corrected the method used for calculating the CRC checksum to "X-modem" in Section 11.7 on <a href="#">page 267</a>.</p>
	23 Oct 2013	<p>New cover photo.</p> <p>Updated the mail addresses in the Contact section.</p> <p>Renaming throughout the manual: Changed</p> <ul style="list-style-type: none"> <li>■ pylon driver package to Basler pylon Camera Software Suite</li> <li>■ IP Configuration Tool to IP Configurator</li> <li>■ pylon Viewer Tool to pylon Viewer</li> </ul> <p>Replaced Kodak by Truesense Imaging in Section 1.2 on <a href="#">page 2</a>.</p> <p>Entered the new IR cut filter characteristics data in Section 1.4.2 on <a href="#">page 7</a>.</p> <p>Added LZ4 licensing information in Section 1.6.2 on <a href="#">page 14</a>.</p> <p>Added note on the "Full" and "Basic" camera description files in Section 2 on <a href="#">page 20</a>.</p> <p>Removed abs. max. voltages (30.0 VDC) from sub-sections of Section 5.</p> <p>Added advice about maximum power-I/O cable length in .</p> <p>Removed "I/O Line Schematic" figure overview.</p> <p>Simplified Figure 13 on <a href="#">page 36</a>, Figure 14 on <a href="#">page 39</a> and Figure 15 on <a href="#">page 39</a>.</p> <p>Indicated LEDs in Figure 11 on <a href="#">page 30</a>.</p> <p>"I/O Control" chapter:</p> <ul style="list-style-type: none"> <li>■ Added Section 6.1.3 on <a href="#">page 44</a> ("Using an Unassigned Input Line to Receive a User Input Signal")</li> <li>■ Added Section 6.1.4 on <a href="#">page 44</a> ("Setting an Input Line for Invert").</li> <li>■ Renamed section "Selecting an Input Line as the Source Signal for a Camera Function" to "Assigning an Input Line to Receive a Hardware Trigger Signal" in the "Physical Interface" and "I/O Control" chapters.</li> <li>■ Renamed section "Selecting the Source Signal for an Output Line" to "Assigning a Camera Output Signal to an Output Line" in the "Physical Interface" and "I/O Control" chapters.</li> </ul> <p>Added paragraph on exposure time settings in "Trigger Width Exposure Mode" on <a href="#">page 78</a>.</p> <p>Adapted the frame start trigger delay range from 10 s to 1 s in Section 7.4.3.3 on <a href="#">page 80</a>.</p>

Doc. ID Number	Date	Changes
AW00097603000	23 Oct 2013	<p>Modified note on availability of the auto functions when the cameras are powered on or reset:</p> <ul style="list-style-type: none"> <li>■ Section 7.5 on <a href="#">page 82</a></li> <li>■ Section 10.2 on <a href="#">page 145</a> and</li> <li>■ in all sub-sections of the "Auto Functions" section from <a href="#">page 164</a>on).</li> </ul> <p>Updated Figure 31 on <a href="#">page 92</a> "Exposure Start Controlled with an ExFSTrig Signal".</p> <p>Added Section 8.3 on <a href="#">page 108</a> (Color Enhancement Features).</p> <p>Added the "White Balance Reset" sub-section on <a href="#">page 109</a> (White Balance section).</p> <p>Integrated the minimum output pulse width feature, see Section 10.8 on <a href="#">page 181</a>.</p> <p>Integrated the sequencer feature, see Section 10.10 on <a href="#">page 185</a>.</p> <p>Added the "Error Codes" section, see 10.9 on <a href="#">page 183</a>.</p> <p>Added note on availability of the auto functions when the cameras are powered on or reset (in all sub-sections of Section 10.7 on <a href="#">page 164</a>).</p> <p>Integrated that the balance white auto function can now also be operated in the "continuous" mode of operation (Section 10.7.9 on <a href="#">page 179</a>).</p> <p>Added the gray value adjustment damping feature in Section 10.7.7 on <a href="#">page 177</a>. Added sentence concerning gray value adjustment damping in Section "Using an Auto Function" on <a href="#">page 172</a>.</p> <p>Deleted the following entry in the pylon setup list "A variety of adapters for third party software imaging processing libraries"</p> <p>Added notes on the "full" camera description file in Section 2 on <a href="#">page 20</a>, Section 8.3.3 on <a href="#">page 112</a>, Section 8.3.4 on <a href="#">page 116</a>, and Section 10.10 on <a href="#">page 185</a>.</p> <p>Added note box in Section 10.2 on <a href="#">page 145</a>.</p> <p>Added the critical temperature condition in Section 10.18.2 on <a href="#">page 246</a>.</p> <p>Added the chunk Stride parameter in Section 11.2 on <a href="#">page 256</a>.</p> <p>Added the "Sequence Set Index" section on <a href="#">page 269</a>.</p> <p>Added the Save Feature... command on <a href="#">page 273</a> in Section 12.</p>

Doc. ID Number	Date	Changes
AW00097604000	07 Mar 2018	<p>Removed cross-references to the <i>aviator GigE Quick Installation Guide</i> (AW000977) throughout the manual.</p> <p>Updated the layout of the information and notice boxes throughout the manual.</p> <p>Changed "Subpart J" to "Subpart B" on the reverse of the front page.</p> <p>Renamed and updated the "Observe the Following Items:" section on <a href="#">page 19</a>.</p> <p>Changed "Truesense Imaging" to "ON Semiconductor" in Section 1.2 on <a href="#">page 2</a>.</p> <p>Indicated RoHS conformity as included in CE conformity and added REACH conformity in Section 1.2 on <a href="#">page 2</a>.</p> <p>Removed "Max" from "Max Power Consumption" in the specifications table in Section 1.2 on <a href="#">page 2</a>.</p> <p>Added Section 1.3 on <a href="#">page 5</a> "Accessories".</p> <p>Added the "Mechanical Stress Test Results" in Section 1.5.4 on <a href="#">page 12</a>.</p> <p>Added the precaution not to apply compressed air in Section 1.9 on <a href="#">page 17</a>.</p> <p>Added precautions relating to SELV and LPS requirements and to cleaning in Section 1.9 on <a href="#">page 17</a>.</p> <p>Updated information about the Basler pylon Camera Software Suite in Chapter 3 on <a href="#">page 21</a>.</p> <p>Removed the "Camera Connector Types " section and transferred part number information to Section 5.1 on <a href="#">page 30</a>.</p> <p>Modified Chapter 5 on <a href="#">page 30</a> and removed wiring information.</p> <p>Added Section 5.3.2.1 on <a href="#">page 33</a> "Grounding Information".</p> <p>Updated Section 6.1.2 on <a href="#">page 42</a> ("Input Line Debouncer").</p> <p>Added a note about the Instant Camera classes in Chapter 7 on <a href="#">page 55</a>.</p> <p>Updated Section 8.3.3 on <a href="#">page 112</a> (added explanation for LightSourceSelector Off and how the coefficients are set).</p>

## Index

### A

acquisition frame count parameter .....64, 66  
 acquisition frame rate abs parameter.72, 74  
 acquisition mode parameter .....60  
 acquisition start command.....55, 60  
 acquisition start overtrigger event .....235  
 acquisition start trigger .....56  
     details.....62  
 acquisition start trigger mode parameter..62  
 acquisition status indicator .....86  
 acquisition status parameter .....86  
 acquisition stop command.....55, 60  
 acquisition trigger wait signal .....87  
 active configuration set.....247  
 active set .....186  
 adjustment damping  
     gray value ~ .....177  
 advance  
     asynchronous.....189  
 AOI .....159  
     image .....159  
 API, pylon .....21  
 area of interest  
     auto functions AOI.....164, 167  
     centering .....159  
     image .....159  
 asynchronous advance .....189  
 asynchronous restart.....189  
 auto function AOI  
     setting.....171  
 auto functions  
     area of interest .....167  
     assignment to an auto function AOI.168  
     introduction.....164  
     modes of operation .....166  
     using with binning.....165  
 auto functions AOI  
     explained.....164  
     relating to an auto function .....168  
 auto functions factory setup .....247  
 auto functions profile .....178  
 auto sequence set advance mode .....191

### B

balance white auto .....179  
 bandwidth assigned parameter .....286

bandwidth reserve accumulation  
     parameter .....287  
 bandwidth reserve parameter.....287  
 bandwidth, managing .....292  
 Bayer filter .....104  
 Bayer GB 12 packed pixel format.....135  
 Bayer GB 12 pixel format .....133  
 Bayer GB 8 pixel format .....131  
 binning.....223  
 bit depth.....2, 4  
 black level  
     explained.....149  
     in four tap digitization mode .....149  
     in one tap digitization mode .....151  
 block diagram, camera .....26, 29

### C

cables  
     Ethernet.....32  
     Power-I/O .....32  
     Power-I/O PLC+ .....32  
 camera description file .....20  
 camera driver .....21  
 camera feature set .....253  
 camera power.....34  
 chunk dynamic range max parameter ....257  
 chunk dynamic range min parameter .....257  
 chunk enable parameter  
     ..... 258, 261, 262, 265, 267, 269  
 chunk frame counter parameter .....258  
 chunk height parameter.....257  
 chunk line status all parameter.....265  
 chunk mode.....256  
 chunk mode active parameter .....256  
 chunk offset x parameter .....257  
 chunk offset y parameter.....257  
 chunk parser  
     ..... 257, 258, 261, 262, 265, 267, 269  
 chunk pixel format parameter.....257  
 chunk selector .....265  
 chunk sequence set index parameter ....269  
 chunk time stamp parameter.....261  
 chunk trigger input counter parameter ...262  
 chunk width parameter .....257  
 code snippets, proper use .....18

color factory setup .....247, 249  
 color filter .....104  
 configuration set loaded at startup .....252  
 configuration sets .....247–252  
   explained .....247  
 conformity .....3, 4  
 connectors .....30  
 continuous acquisition mode .....60  
 controlled sequence set advance mode .....197  
 CPU interrupts .....294  
 CRC checksum chunk .....267  
 critical temperature .....246  
 current set .....186

## D

damping  
   gray value adjustment ~ .....177  
 debouncer  
   and exposure start delay .....91  
   explained .....42  
   setting .....43, 181  
 default configuration set .....247  
 device current throughput parameter .....290  
 device firmware version parameter .....243  
 device ID parameter .....243  
 device manufacturer info parameter .....243  
 device max throughput parameter .....289  
 device model name parameter .....243  
 device scan type parameter .....243  
 device user ID parameter .....243  
 device vendor name parameter .....243  
 device version parameter .....243  
 digital shift .....153  
 dimensions .....2, 4, 8  
 driver, camera .....21  
 drivers, network .....274  
 dust .....17

## E

electromagnetic interference .....15  
 electrostatic discharge .....15  
 EMI .....15  
 enable resend parameter .....275, 277  
 end of exposure event .....235  
 environmental requirements .....16  
 ESD .....15  
 event overrun event .....235  
 event reporting .....235

exposure  
   overlapped .....83  
 exposure active signal .....85  
 exposure auto .....175  
 exposure mode  
   timed .....78  
 exposure modes  
   trigger width .....79  
 exposure start delay .....91  
 exposure time  
   controlling with an external trigger  
   signal .....77  
   maximum possible .....82  
   minimum allowed .....82  
 exposure time abs parameter .....72, 74  
 extended image data chunk .....256

## F

factory setup .....247  
   auto functions factory setup .....247  
   color factory setup .....247  
   high gain factory setup .....247  
   standard factory setup .....247  
 feature set .....253  
 filter driver .....274  
 four tap digitization .....24  
 four tap sensor readout .....23  
 frame .....55  
 frame counter chunk .....258  
   reset .....259  
 frame rate  
   and AOI size .....93  
   controlling with an external trigger  
   signal .....77  
   max allowed .....93  
 frame readout time .....91  
 frame retention parameter .....275  
 frame start overtrigger event .....235  
 frame start trigger .....56, 188  
   details .....71  
 frame start trigger delay .....69, 80  
 frame start trigger mode parameter .....72  
 frame transmission delay parameter .....286  
 frame transmission time .....91  
 frame trigger wait signal .....89  
 free run .....96  
 free selection sequence set advance  
 mode .....216  
 functional description .....23



**G**

gain.....	145
in four tap digitization mode .....	146
in one tap digitization mode .....	148
gain auto.....	173
gamma correction.....	110
gray value	
~ adjustment damping.....	177

**H**

hardware trigger	
acquisition start .....	68
frame start .....	77
heartbeat timeout parameter .....	284
heartbeat timer .....	284
heat dissipation .....	16
height	
AOI .....	159
high gain factory setup .....	247
horizontal binning .....	223
humidity .....	16

**I**

image AOI .....	159
imaging sensor temperature.....	245
input line	
configuring.....	41
input lines .....	35, 38
electrical characteristics .....	36
inverter .....	44
installation	
hardware .....	20
software.....	20
integrate enabled signal .....	85
inter-packet delay .....	275, 280, 293
inverter	
input lines .....	44
output line.....	48
IP Configurator .....	22
IP30 .....	8
IR cut filter .....	7, 11, 107

**J**

jumbo frames.....	295
jumbo packets .....	295

**L**

lens adapter.....	2, 4
lens thread length.....	11
line inverter parameter .....	44, 48
line selector .....	45, 89, 90
line source parameter.....	45, 89, 90
line status .....	202
line status all chunk .....	265
line status parameter.....	54
lookup table .....	232
LPS	
see power supply .....	17
luminance lookup table.....	232
LUT.....	232
LUT enable parameter .....	234
LUT index parameter.....	234

**M**

max frame jitter parameter .....	289
max frame rate .....	93
max height parameter .....	243
max number resend request parameter .....	280
max width parameter.....	243
maximum lens thread length .....	11
mechanical drawings.....	8
minimum output pulse width.....	181
mirror imaging .....	227
missing packet	
detection.....	276
status.....	276
models.....	1
modes of operation (of auto functions).....	166
mono 12 packed pixel format .....	128
mono 12 pixel format.....	126
mono 8 pixel format.....	125, 141
mounting holes .....	8
multiple cameras on a network.....	292

**N**

network adapter, packet size.....	295
network drivers .....	274
network parameter .....	294
network performance.....	294
network switch, packet size.....	295
non-sequence parameter .....	186

**O**

one tap digitization .....	27
one tap sensor readout .....	27
optical size, sensor .....	2, 4
output line	
configuring .....	45
electrical characteristics .....	38
inverter .....	48
response time .....	40
source signal .....	40
voltage requirements .....	38
over temperature .....	246
over triggering .....	77
overlapped exposure .....	83

**P**

packet size	
camera .....	295
network adapter .....	295
network switch .....	295
packet size parameter .....	285
packet timeout parameter .....	275, 280, 286
parameter sets	
explained .....	247
saving .....	250
parameters loaded at startup .....	252
payload size parameter .....	285
performance driver .....	274
pin assignments .....	31
pin numbering .....	31
pixel format parameter .....	124
pixel formats .....	123
Bayer BG 12 .....	133
Bayer GB 12 packed .....	135
Bayer GB 8 .....	131
mono 12 .....	126
mono 12 packed .....	128
mono 8 .....	125, 141
YUV 422 (YUYV) packed .....	130, 139
YUV 422 packed .....	130, 137
pixel readout .....	24, 27
pixel size .....	2, 4
pixel transmission sequence .....	143
power requirements, camera .....	34
Power-I/O cable .....	32
Power-I/O PLC+ cable .....	32
precautions .....	17
prelines .....	162
protection class .....	8

pylon Camera Software Suite .....	21
pylon Viewer .....	22

**R**

read timeout parameter .....	284
readout time abs parameter .....	84, 92
receive descriptors .....	294
receive window .....	276
receive window size parameter .....	277
remove parameter limits .....	152
resend request batching parameter .....	278
resend request response timeout parameter .....	280
resend request threshold parameter .....	278
resend timeout parameter .....	280
restart	
asynchronous .....	189
synchronous .....	189
resulting frame rate parameter .....	290
return material authorization .....	270
reverse X .....	227
reverse Y .....	229
RMA number .....	270

**S**

saving parameter sets .....	250
SELV	
see power supply	
sensor	
architecture .....	25, 28
optical size .....	2, 4
pixel size .....	2, 4
position accuracy .....	10
size in pixels .....	2, 4
type .....	2, 4
sensor digitization taps .....	144
sensor height parameter .....	243
sensor readout .....	24, 27
sensor width parameter .....	243
sequence	
cycle .....	191
sequence advance mode .....	185
sequence parameter .....	186

- sequence set .....185  
 address .....219  
 configuration..... 194, 212, 220  
 index number .....187  
 load .....190  
 store ..... 194, 213, 220  
 sequence set advance mode  
 auto .....191  
 free selection.....216  
 sequence set cycle.....189  
 sequence set index chunk.....269  
 sequence set index number .....187  
 sequencer.....185  
 standard operation .....189  
 serial number.....19  
 sets of parameters, saving .....250  
 single frame acquisition mode.....60  
 size, camera .....2, 4  
 software trigger  
 acquisition start .....66  
 frame start.....75  
 spectral response  
 color cameras.....7  
 mono cameras .....6  
 speed and duplex mode parameter.....294  
 squence set  
 address .....216  
 sRGB gamma.....110  
 standard factory setup.....247  
 start delay  
 exposure .....91  
 transmission .....91  
 startup parameter set .....252  
 startup set.....248  
 support .....270  
 synchronous advance .....189  
 synchronous restart.....189
- T**
- target value.....164  
 technical support .....270  
 temperature  
 critical ~ .....246  
 imaging sensor .....245  
 over ~ .....246  
 temperature, housing .....16  
 test images .....239  
 time delay time base abs parameter .....50  
 time stamp chunk .....261  
 timed exposure mode .....78
- timer delay.....51  
 timer delay abs parameter.....51  
 timer delay raw parameter.....50  
 timer delay time .....50  
 timer delay time base .....50  
 timer duration .....52  
 timer duration abs parameter .....53  
 timer duration raw parameter .....52  
 timer duration time base.....52  
 timer duration time base abs parameter...52  
 timer selector..... 49, 50, 52, 53  
 timer trigger source parameter .....49  
 total start delay .....91  
 transition threshold, input lines.....35  
 transmission start delay.....91  
 trigger delay  
 frame start.....69  
 trigger delay, frame start .....80  
 trigger input counter chunk.....262  
 reset .....263  
 trigger wait signals.....87  
 trigger width exposure mode .....79
- U**
- use case diagrams .....96, 191  
 user configuration set .....248  
 user defined values .....238  
 user output selector.....47  
 user output value parameter .....47
- V**
- ventilation .....16  
 vertical binning .....223  
 viewer .....22
- W**
- weight .....2, 4  
 white balance .....108  
 white balance auto  
 see balance white auto  
 width  
 AOI .....159  
 write timeout parameter.....284

**Y**

YUV 422 (YUYV) packed pixel format.....	
.....	130, 139
YUV 422 data range.....	138
YUV 422 packed pixel format.....	130, 137